

ONKYO®

SKW-205

POWERED SUBWOOFER

SKW-205
POWERED SUBWOOFER

English

Instruction manual

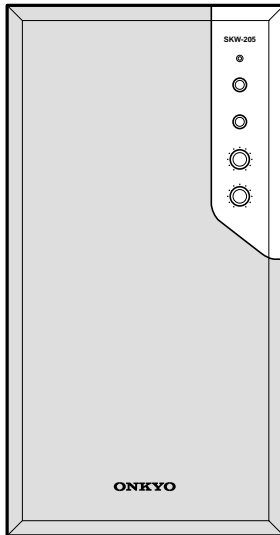

SKW-205

Thank you for your purchase of the Onkyo powered subwoofer.

Please read this manual thoroughly before using it.

Following the instructions in this manual will enable you to obtain optimum performance and listening enjoyment from your new powered subwoofer.

Please retain this manual for future reference.

WARNING:

TO REDUCE THE RISK OF FIRE OR ELECTRIC SHOCK, DO NOT EXPOSE THIS APPLIANCE TO RAIN OR MOISTURE.

CAUTION:

TO REDUCE THE RISK OF ELECTRIC SHOCK, DO NOT REMOVE COVER (OR BACK). NO USER-SERVICEABLE PARTS INSIDE. REFER SERVICING TO QUALIFIED SERVICE PERSONNEL.



- The lightning flash with arrowhead symbol, within an equilateral triangle, is intended to alert the user to the presence of uninsulated "dangerous voltage" within the product's enclosure that may be of sufficient magnitude to constitute a risk of electric shock to persons.
- The exclamation point within an equilateral triangle is intended to alert the user to the presence of important operating and maintenance (servicing) instructions in the literature accompanying the appliance.

Important safeguards

- Read Instructions** – All the safety and operating instructions should be read before the appliance is operated.
- Retain Instructions** – The safety and operating instructions should be retained for future reference.
- Heed Warnings** – All warnings on the appliance and in the operating instructions should be adhered to.
- Follow Instructions** – All operating and use instructions should be followed.
- Cleaning** – Unplug the appliance from the wall outlet before cleaning. The appliance should be cleaned only as recommended by the manufacturer.
- Attachments** – Do not use attachments not recommended by the appliance manufacturer as they may cause hazards.
- Water and Moisture** – Do not use the appliance near water –for example, near a bath tub, wash bowl, kitchen sink, or laundry tub; in a wet basement; or near a swimming pool; and the like.
- Accessories** – Do not place the appliance on an unstable cart, stand, tripod, bracket, or table. The appliance may fall, causing serious injury to a child or adult, and serious damage to the appliance. Use only with a cart, stand, tripod, bracket, or table recommended by the manufacturer, or sold with the appliance. Any mounting of the appliance should follow the manufacturer's instructions, and should use a mounting accessory recommended by the manufacturer.
- An appliance and cart combination should be moved with care. Quick stops, excessive force, and uneven surfaces may cause the appliance and cart combination to overturn.

PORTABLE CART WARNING

S3125A
- Ventilation** – Slots and openings in the cabinet are provided for ventilation and to ensure reliable operation of the appliance and to protect it from overheating, and these openings must not be blocked or covered. The openings should never be blocked by placing the appliance on a bed, sofa, rug, or other similar surface. The appliance should not be placed in a builtin installation such as a bookcase or rack unless proper ventilation is provided. There should be free space of at least 20 cm (8 in.) and an opening behind the appliance.
- Power Sources** – The appliance should be operated only from the type of power source indicated on the marking label. If you are not sure of the type of power supply to your home, consult your appliance dealer or local power company.
- Grounding or Polarization** – The appliance may be equipped with a polarized alternating current line plug (a plug having one blade wider than the other). This plug will fit into the power outlet only one way. This is a safety feature. If you are unable to insert the plug fully into the outlet, try reversing the plug. If the plug should still fail to fit, contact your electrician to replace your obsolete outlet. Do not defeat the safety purpose of the polarized plug.
- Power-Cord Protection** – Powersupply cords should be routed so that they are not likely to be walked on or pinched by items placed upon or against them, paying particular attention to cords at plugs, convenience receptacles, and the point where they exit from the appliance.
- Lightning** – For added protection for the appliance during a lightning storm, or when it is left unattended and unused for long periods of time, unplug it from the wall outlet and disconnect the antenna or cable system. This will prevent damage to the appliance due to lightning and power-line surges.
- Overloading** – Do not overload wall outlets, extension cords, or integral convenience receptacles as this can result in a risk of fire or electric shock.
- Object and Liquid Entry** – Never push objects of any kind into the appliance through openings as they may touch dangerous voltage points or short-out parts that could result in a fire or electric shock. Never spill liquid of any kind on the appliance.
- Servicing** – Do not attempt to service the appliance yourself as opening or removing covers may expose you to dangerous voltage or other hazards. Refer all servicing to qualified service personnel.
- Damage Requiring Service** – Unplug the appliance from the wall outlet and refer servicing to qualified service personnel under the following conditions:
 - When the power-supply cord or plug is damaged,
 - If liquid has been spilled, or objects have fallen into the appliance,
 - If the appliance has been exposed to rain or water,
 - If the appliance does not operate normally by following the operating instructions. Adjust only those controls that are covered by the operating instructions as an improper adjustment of other controls may result in damage and will often require extensive work by a qualified technician to restore the appliance to its normal operation,
 - If the appliance has been dropped or damaged in any way, and
 - When the appliance exhibits a distinct change in performance – this indicates a need for service.
- Replacement Parts** – When replacement parts are required, be sure the service technician has used replacement parts specified by the manufacturer or have the same characteristics as the original part. Unauthorized substitutions may result in fire, electric shock, or other hazards.
- Safety Check** – Upon completion of any service or repairs to the appliance, ask the service technician to perform safety checks to determine that the appliance is in proper operation condition.
- Wall or Ceiling Mounting** – The appliance should be mounted to a wall or ceiling only as recommended by the manufacturer.
- Heat** – The appliance should be situated away from heat sources such as radiators, heat registers, stoves, or other appliances (including amplifiers) that produce heat.

Precautions

1. Warranty card

You can find the serial number on the rear panel of this unit. In case of warranty claim, please report this number.

2. Recording Copyright

Recording of copyrighted material for other than personal use is illegal without permission of the copyright holder.

3. AC Fuse

The fuse is located inside the chassis and is not user-servicable.

If power does not come on, contact your Onkyo authorized service station.

4. Care

From time to time you should wipe off the front and rear panels and the cabinet with a soft cloth. For heavier dirt, dampen a soft cloth in a weak solution of mild detergent and water, wring it out dry, and wipe off the dirt. Following this, dry immediately with a clean cloth. Do not use rough material, thinners, alcohol or other chemical solvents or cloths since these may damage the finish or remove the panel lettering.

5. Power

WARNING

BEFORE PLUGGING IN THE UNIT FOR THE FIRST TIME, READ THE FOLLOWING SECTION CAREFULLY.

- The voltage of the available power supply differs according to country or region. Be sure that the power supply voltage of the area where this unit will be used meets the required voltage (e.g., AC230V 50Hz or AC120V 60Hz) written on the rear panel.
- **Models Equipped with a Voltage Selector**
Worldwide models are equipped with a voltage selector to conform to local power supplies. Be sure to set this switch to match the voltage of the power supply in your area before plugging in the unit.

Setting the voltage selector

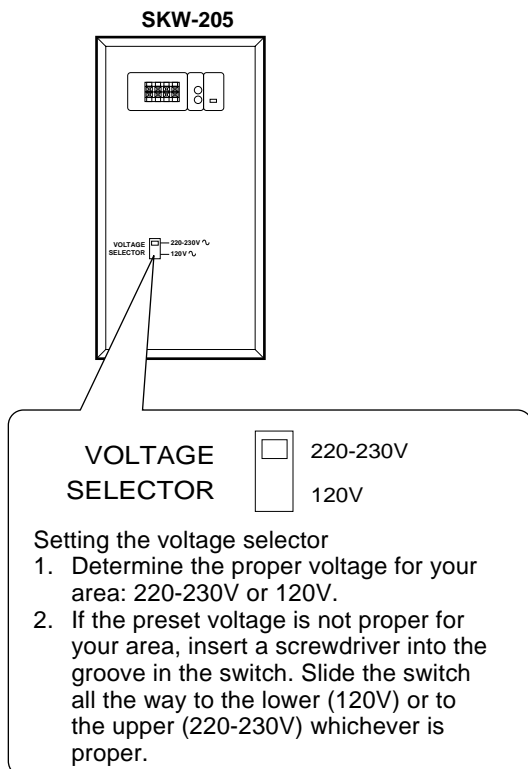

Features

■ This subwoofer system is equipped with a built-in amplifier solely for the reproduction of the superbass range.

■ With the built-in left-right mixing circuit and cut-off filter, you can just connect the unit to your existing system powerful bass reproduction.

Control positions and names

■ Front panel

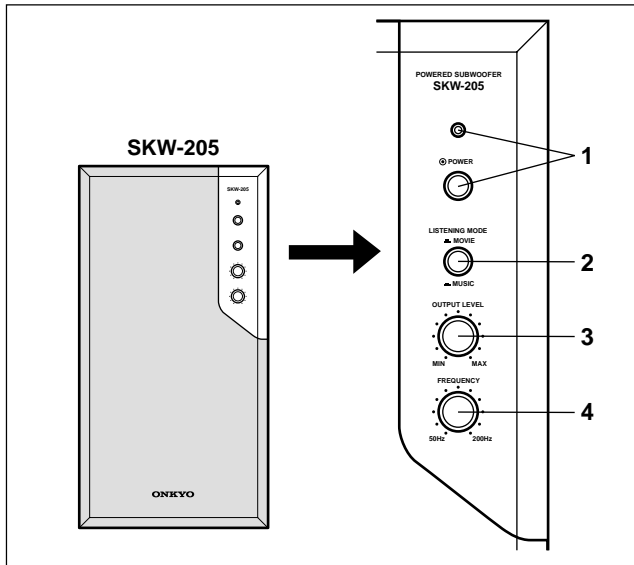

- 1 Power switch (POWER) and indicator**
Pressing this button turns the power on (the indicator lights). Pressing the button again turns the power off (the indicator goes out).
Red: Unit is in standby mode
Green: Unit is in operation
- 2 Mode selector switch (LISTENING MODE)**
Selecting the MOVIE or MUSIC position provides the optimal frequency characteristics for reproducing movie soundtracks or music, respectively. Of course, you can enjoy movie soundtracks and music in either listening mode.
- 3 Output level adjusting knob (OUTPUT LEVEL)**
Use this knob to adjust the output level of the subwoofer.
- 4 Frequency adjusting knob (FREQUENCY)**
Use this knob to select the high-frequency range at which you wish to cut off the signal to the subwoofer. You can select any frequency between 50 Hz and 200 Hz depending on the characteristics of the speaker system being used with the SKW-205.

■ Rear panel

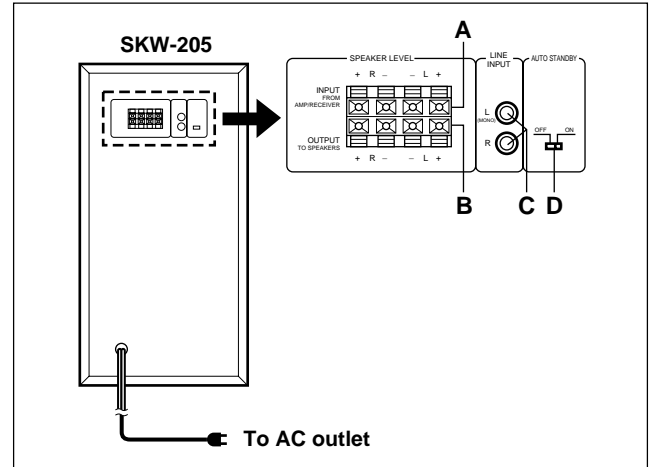

- A Speaker-level input terminals (INPUT FROM AMP/RECEIVER)**
Connect these input terminals to the speaker output terminals of your amplifier or receiver.
 - B Speaker-level output terminals (OUTPUT TO SPEAKERS)**
The speaker-level signal to the front speakers is output from these terminals.
 - C Low-level input jacks (LINE INPUT)**
Connect these jacks to the LINE OUT jacks of the amplifier etc.
 - D Auto standby switch (AUTO STANDBY)**
This switch is used to turn on and off the auto standby function.
ON: This activates the auto standby function. If a constant level signal is not received from the amplifier (or receiver) over a period of a few minutes, the SKW-205 automatically enters the standby state. If a constant level signal is later received from the amplifier (or receiver), the power is automatically turned back on.
OFF: Deactivates the auto standby function.
- Note:**
- The auto standby function operates on the existence or absence of a constant level input signal. If the auto standby function does not operate properly, try slightly increasing (or decreasing) the output level of the amplifier or receiver. (Note that output levels of some amplifiers and receivers cannot be adjusted. For more details regarding your components, refer to the instruction manual supplied with them.)
 - If noise from peripheral components causes the incorrect operation of the auto standby function, or if outputting low volumes (i.e., during the nighttime) causes the auto standby function to activate, turn off the auto standby function.
 - The auto standby function only operates while the power switch for the SKW-205 is turned on.

Connections

For safety, be sure to turn off the power of this unit and all other system components before connecting or disconnecting any components.

■ When used in combination with an AV amplifier

When using the SKW-205 in conjunction with AV amplifiers and receivers with surround capability, be sure to connect the SKW-205 to the subwoofer preout terminal (SUBWOOFER PREOUT) using the supplied pin cable. If connected using speaker cable, depending on the amplifier or receiver settings, the bass signals may be cut out resulting in decreased fidelity in the lower bass sounds.

For more details regarding proper connecting procedures, refer to the instruction manual supplied with your amplifier or receiver.

■ Connection with amplifier's special subwoofer jack

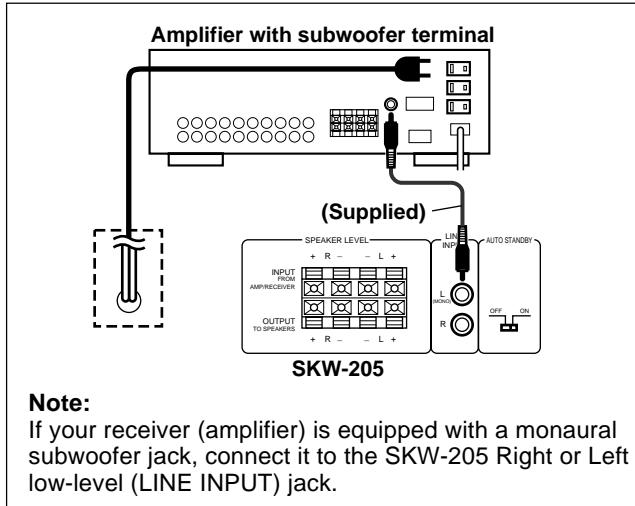

■ Connection with a preamplifier

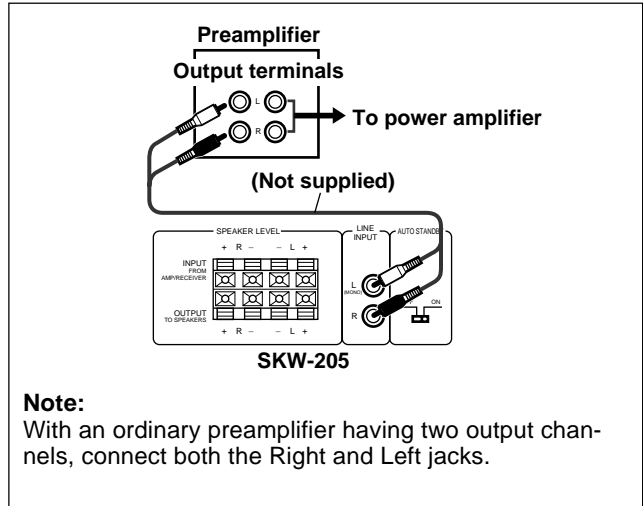

■ Connection to receiver's (amplifier's) speaker terminals

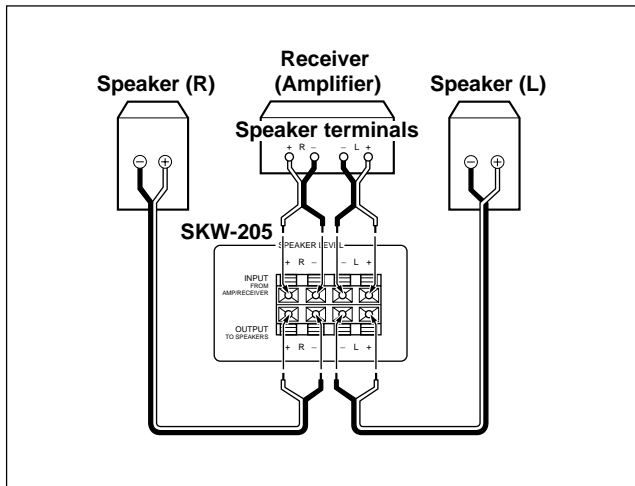

1. Using the supplied speaker cables and speaker cables that came with your speakers, connect the SKW-205 speaker-level input (INPUT FROM AMP/ RECEIVER) terminals and the amplifier's speaker terminals.
2. Connect the Right and Left speakers to the SKW-205 speaker-level output (OUTPUT TO SPEAKERS) terminals.

Note:

- When connecting the speaker cables, be sure not to mistake the (+) and (-) and the L (left) and R (right). If the speaker cables are connecting incorrectly, there will be a loss of fidelity in the bass sound ranges.
- The speakers connected to the SKW-205 speaker-level output (OUTPUT TO SPEAKERS) terminals must have an impedance equal to or greater than the rating indicated on the amplifier connected to the speaker-level input (INPUT FROM AMP/ RECEIVER) terminals. Otherwise, amplifier damage may occur.

Connecting the speaker cables

1. Press the lever of the speaker output terminal, fully insert the twisted core wires into the terminal hole, and then release the lever.
2. Pull the speaker cable lightly to ensure that it is connected firmly.

Note:

- When you have connected the speaker cables, make sure that the core wires are not in contact with other terminals or metallic parts of the unit.
- Do not use BTL (Balanced Transformer-Less) type amplifiers. Using a BTL amplifier may cause damage to both the amplifier and the subwoofer. Ordinary amplifiers are not BTL amplifiers. For details, see the amplifier's instruction manual.

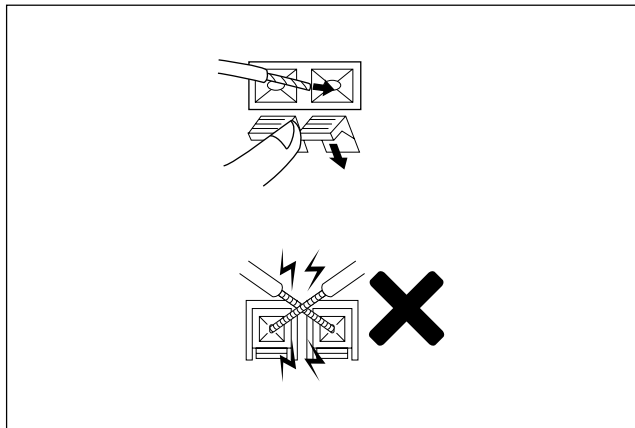

Subwoofer effects

Adding a subwoofer to your speaker system expands the bandwidth of reproduced bass-range sound. If the subwoofer's reproduction bandwidth or sound output level is improperly adjusted, however, the overall performance may be decreased as shown in the graphs below.

■ When subwoofer's reproduction bandwidth is correct

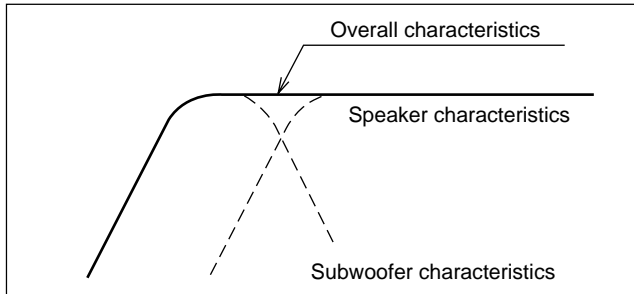

■ When subwoofer's reproduction bandwidth is far from speaker's bandwidth

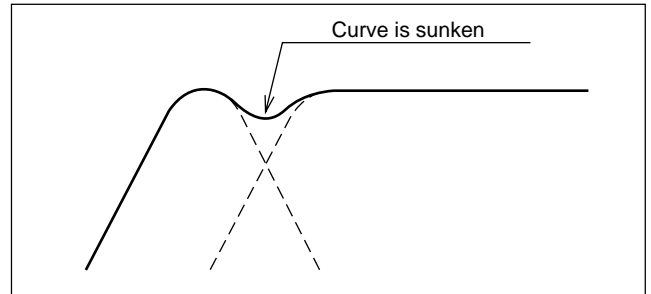

■ When subwoofer's output level is incorrect

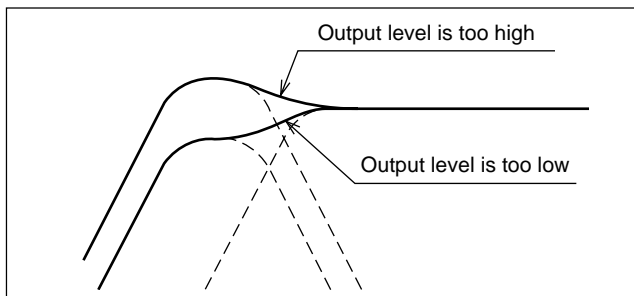

■ When subwoofer's reproduction bandwidth is close to speaker's bandwidth

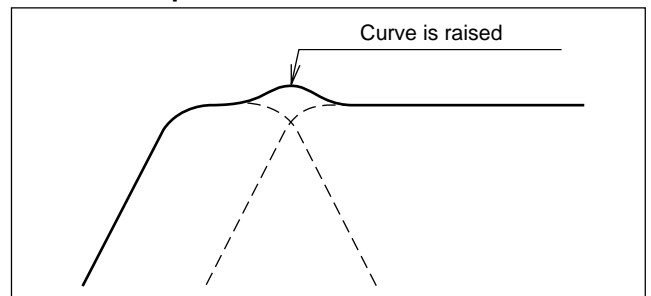

Adjustments

■ Crossover frequency and output level

- Adjust the SKW-205 output level and the crossover frequency properly for your listening room and connected speakers.
- When the unit is connected to an amplifier via the speaker-level input (INPUT FROM AMP/RECEIVER) terminals, setting the OUTPUT LEVEL knob near the center position will provide a well-balanced sound level with most speakers.
- Note that you may possibly set the subwoofer at high output levels because superbass-range sound is not so audible as sound in other ranges. To obtain well-balanced frequency characteristics, set the output level to a slightly lower level than seems optimal. (This will also prevent the input of too strong signals.)

The placement of the SKW-205 can greatly affect the sound that is produced. Under normal circumstances, placement in the corner of the room provides the best results.

Note:

Be careful not to allow the input of excessive power. Input levels that greatly exceed normal situations can damage the SKW-205. Also note that switching operations at the amplifier can also cause excessive noises that may cause damage. When using switches at the amplifier, first lower the volume to prevent accidental damage.

Precaution on use

■ Placement

- The enclosure is made of wood and therefore sensitive to extreme temperatures and humidity. Avoid placing the unit in locations subjected to direct sunlight or in humid places such as near an air conditioner, bathroom or kitchen, as well as in locations subjected to soot or steam such as near a kitchen table and humidifier. Otherwise, damage may occur.
- Keep water or other liquids away from the unit. If water is spilled into the unit, not only the unit but also the connected receiver (amplifier) may be damaged.
- Place the unit on a level and rigid surface free from vibration.
- Four slip-proof spacers are provided with the SKW-205. If the SKW-205 is to be placed on flooring or other similar surfaces, attach these spacers to the bottom surface at the corners. This will not only prevent scratching, but also provide a stable footing. However, note that depending on the surface, the spacers may leave markings.
- This unit is designed to be used in the upright vertical position only. Do not use it in the horizontal or tilted position.
- If the unit is used near a turntable or CD player, howling or skipping of sound may occur. To prevent this, move the unit away from the turntable or CD player or otherwise lower the unit's output level.

- This unit can handle the specified input power when it is used for ordinary music reproduction. If the following abnormal signals are fed to the unit, however, an overcurrent may flow in the internal circuits, causing burning or breakage of the wires even if the input power is below the specified rating.
 1. Special test signals produced by audio checking CD, etc.
 2. Sound produced when connecting or disconnecting audio connection cables
(Always turn off the amplifier's power before connecting or disconnecting cables.)

3. Howling when a microphone is used
4. Abnormal sound produced when bass-range signals are excessively boosted by using the receiver's (amplifier's) tone controls, a graphic equalizer, etc., or when a source whose bass range is abnormally boosted is being played. This state called "rattling" occurs when the signal is beyond the driver's reproduction capacity. Although it is not a sign of damage, decrease the speaker output level to prevent damage to the driver.

Troubleshooting guide

Symptom	Cause	Remedy
The unit does not turn on.	<ul style="list-style-type: none"> • The power plug is not fully inserted. 	<ul style="list-style-type: none"> • Insert the power plug fully into the power outlet.
No sound output	<ul style="list-style-type: none"> • The OUTPUT LEVEL knob is set to the MIN level. • Pin-connector cable(s) are disconnected at the LINE INPUT jacks. • Speaker cables are not properly connected to the INPUT FROM RECEIVER terminals. • The input signal is so small that the unit entered the standby state. 	<ul style="list-style-type: none"> • Set the OUTPUT LEVEL knob properly. • Connect cable(s) to the LINE INPUT jacks. • Connect the speaker cables properly. • Set the AUTO STANDBY switch to OFF.
Small sound output	<ul style="list-style-type: none"> • Speaker cables are connected to the INPUT FROM RECEIVER terminals with reversed phase. • Playing source does not include superbass sound. 	<ul style="list-style-type: none"> • Connect the speaker cables properly. • Play sources with superbass sound.
Hum noise	<ul style="list-style-type: none"> • Pin-connector is not inserted completely. • External leakage flux (induction noise by TV etc.) occurs. 	<ul style="list-style-type: none"> • Fully insert the pin-connector. • Separate from the noise source and connect.

Specifications

Type	Bass-reflex with built-in power amplifier	Speaker	20-cm woofer
Use	For superbass-range reproduction	Power supply	AC 220-230 V and 120 V switchable, 50/60 Hz
Frequency response	30-200 Hz (at maximum crossover frequency)	Power consumption	42 W
Crossover frequency	50-200 Hz (variable)	Dimensions (W × H × D)	235 × 455 × 347 (mm) 9-1/4" × 17-15/16" × 13-11/16"
Maximum output power	60 W	Weight	11.2 kg 24.7 lbs
Input impedance	4.7 kΩ (for speaker-level input terminals) 12 kΩ (for low-level input jacks)	Others	AUTO STANDBY ON/OFF (with CANCELLING Switch) MOVIE/MUSIC mode selection Magnetic shielding
Sensitivity			
Speaker-Level	0.8 V		
Line	30 mV		

* Specifications and appearance may subject to change for improvement without prior notice.

ONKYO CORPORATION

Sales & Product Planning Div. : 2-1, Nisshin-cho, Neyagawa-shi, OSAKA 572-8540, JAPAN
Tel: 072-831-8111 Fax: 072-833-5222 <http://www.onkyo-intl.com>

ONKYO EUROPE ELECTRONICS GmbH

Liegnitzerstrasse 6, 82194 Groebenzell, GERMANY
Tel: +49-8142-4401-0 Fax: +49-8142-4401-555 <http://www.onkyo.net>

ONKYO CHINA LIMITED

Units 2102-2107, Metroplaza Tower I, 223 Hing Fong Road, Kwai Chung,
N.T., HONG KONG Tel: 852-2429-3118 Fax: 852-2428-9039 <http://www.onkyochina.com>

