



5.1 Ch Home Theater Speaker Package

HTP-240

6.1 Ch Home Theater Speaker Package

SKS-HT240

Instruction Manual

Thank you for purchasing an Onkyo home theater speaker package. Please read this manual thoroughly before using your new speakers. Following the instructions in this manual will enable you to obtain optimum performance and listening enjoyment from your speaker package.
Please retain this manual for future reference.

Contents

Getting Started

- Important Safeguards 2
- Precautions 3
- Introduction 4
- Package Contents 4
- Getting to know Your Speaker Package 5

Installing & Using

- Various Mounting Methods 6
- Connecting the Speakers 8
- About Home Theater 9
- Adjustment 10

Appendix

- Caring for Your Speakers..... 10
- Troubleshooting 11
- Specifications..... 11



WARNING:

TO REDUCE THE RISK OF FIRE OR ELECTRIC SHOCK, DO NOT EXPOSE THIS APPLIANCE TO RAIN OR MOISTURE.

CAUTION:

TO REDUCE THE RISK OF ELECTRIC SHOCK, DO NOT REMOVE COVER (OR BACK). NO USER-SERVICEABLE PARTS INSIDE. REFER SERVICING TO QUALIFIED SERVICE PERSONNEL.



WARNING
RISK OF ELECTRIC SHOCK
DO NOT OPEN

AVIS
RISQUE DE CHOC ELECTRIQUE
NE PAS OUVRIR



The lightning flash with arrowhead symbol, within an equilateral triangle, is intended to alert the user to the presence of uninsulated "dangerous voltage" within the product's enclosure that may be of sufficient magnitude to constitute a risk of electric shock to persons.



The exclamation point within an equilateral triangle is intended to alert the user to the presence of important operating and maintenance (servicing) instructions in the literature accompanying the appliance.

Important Safeguards

1. **Read Instructions** – All the safety and operating instructions should be read before the appliance is operated.
2. **Retain Instructions** – The safety and operating instructions should be retained for future reference.
3. **Heed Warnings** – All warnings on the appliance and in the operating instructions should be adhered to.
4. **Follow Instructions** – All operating and use instructions should be followed.
5. **Cleaning** – Unplug the appliance from the wall outlet before cleaning. The appliance should be cleaned only as recommended by the manufacturer.
6. **Attachments** – Do not use attachments not recommended by the appliance manufacturer as they may cause hazards.
7. **Water and Moisture** – Do not use the appliance near water –for example, near a bath tub, wash bowl, kitchen sink, or laundry tub; in a wet basement; or near a swimming pool; and the like.
8. **Accessories** – Do not place the appliance on an unstable cart, stand, tripod, bracket, or table. The appliance may fall, causing serious injury to a child or adult, and serious damage to the appliance. Use only with a cart, stand, tripod, bracket, or table recommended by the manufacturer, or sold with the appliance. Any mounting of the appliance should follow the manufacturer's instructions, and should use a mounting accessory recommended by the manufacturer.
9. An appliance and cart combination should be moved with care. Quick stops, excessive force, and uneven surfaces may cause the appliance and cart combination to overturn.

PORTABLE CART WARNING



S3125A

10. **Ventilation** – Slots and openings in the cabinet are provided for ventilation and to ensure reliable operation of the appliance and to protect it from overheating, and these openings must not be blocked or covered. The openings should never be blocked by placing the appliance on a bed, sofa, rug, or other similar surface. The appliance should not be placed in a built-in installation such as a bookcase or rack unless proper ventilation is provided. There should be free space of at least 20 cm (8 in.) and an opening behind the appliance.
11. **Power Sources** – The appliance should be operated only from the type of power source indicated on the marking label. If you are not sure of the type of power supply to your home, consult your appliance dealer or local power company.
12. **Grounding or Polarization** – The appliance may be equipped with a polarized alternating current line plug (a plug having one blade wider than the other). This plug will fit into the power outlet only one way. This is a safety feature. If you are unable to insert the plug fully into the outlet, try reversing the plug. If the plug should still fail to fit, contact your electrician to replace your obsolete outlet. Do not defeat the safety purpose of the polarized plug.
13. **Power-Cord Protection** – Power-supply cords should be routed so that they are not likely to be walked on or pinched by items placed upon or against them, paying particular attention to cords at plugs, convenience receptacles, and the point where they exit from the appliance.
14. **Lightning** – For added protection for the appliance during a lightning storm, or when it is left unattended and unused for long periods of time, unplug it from the wall outlet and disconnect the antenna or cable system. This will prevent damage to the appliance due to lightning and power-line surges.
15. **Overloading** – Do not overload wall outlets, extension cords, or integral convenience receptacles as this can result in a risk of fire or electric shock.
16. **Object and Liquid Entry** – Never push objects of any kind into the appliance through openings as they may touch dangerous voltage points or short-out parts that could result in a fire or electric shock. Never spill liquid of any kind on the appliance.
17. **Servicing** – Do not attempt to service the appliance yourself as opening or removing covers may expose you to dangerous voltage or other hazards. Refer all servicing to qualified service personnel.

Important Safeguards—Continued

18. **Damage Requiring Service** – Unplug the appliance from the wall outlet and refer servicing to qualified service personnel under the following conditions:
 - A. When the power-supply cord or plug is damaged,
 - B. If liquid has been spilled, or objects have fallen into the appliance,
 - C. If the appliance has been exposed to rain or water,
 - D. If the appliance does not operate normally by following the operating instructions. Adjust only those controls that are covered by the operating instructions as an improper adjustment of other controls may result in damage and will often require extensive work by a qualified technician to restore the appliance to its normal operation,
 - E. If the appliance has been dropped or damaged in any way, and
 - F. When the appliance exhibits a distinct change in performance – this indicates a need for service.
19. **Replacement Parts** – When replacement parts are required, be sure the service technician has used replacement parts specified by the manufacturer or have the same characteristics as the original part. Unauthorized substitutions may result in fire, electric shock, or other hazards.
20. **Safety Check** – Upon completion of any service or repairs to the appliance, ask the service technician to perform safety checks to determine that the appliance is in proper operation condition.
21. **Wall or Ceiling Mounting** – The appliance should be mounted to a wall or ceiling only as recommended by the manufacturer.
22. **Heat** – The appliance should be situated away from heat sources such as radiators, heat registers, stoves, or other appliances (including amplifiers) that produce heat.
23. **Liquid Hazards** – The appliance should not be exposed to dripping or splashing and no objects filled with liquids, such as vases should be placed on the appliance.

Precautions

1. Mounting

Mount the speakers as explained in this manual. Don't use the front or surround speakers without their bases as damage or injury may result.

2. AC Fuse

The fuse is located inside the chassis and is not user-serviceable. If power does not come on, contact your Onkyo authorized service station.

3. Care

From time to time you should wipe off the front and rear panels and the cabinet with a soft cloth. For heavier dirt, dampen a soft cloth in a weak solution of mild detergent and water, wring it out dry, and wipe off the dirt. Following this, dry immediately with a clean cloth. Do not use rough material, thinners, alcohol or other chemical solvents or cloths since these may damage the finish or remove the panel lettering.

Use a vacuum cleaner to remove dust from hard-to-reach grilles.

4. Power

WARNING

BEFORE PLUGGING IN THE UNIT FOR THE FIRST TIME, READ THE FOLLOWING SECTION CAREFULLY.

The voltage of the available power supply differs according to country or region. Be sure that the power supply voltage of the area where this unit will be used meets the required voltage (e.g., AC 120 V, 60 Hz) written on the rear panel.

For Canadian models

For models having a power cord with a polarized plug:

CAUTION: TO PREVENT ELECTRIC SHOCK, MATCH WIDE BLADE OF PLUG TO WIDE SLOT, FULLY INSERT.

Modèle pour les Canadiens

Sur les modèles dont la fiche est polarisée:

ATTENTION: POUR ÉVITER LES CHOCS ÉLECTRIQUES, INTRODUIRE LA LAME LA PLUS LARGE DE LA FICHE DANS LA BORNE CORRESPONDANTE DE LA PRISE ET POUSSER JUSQU' AU FOND.

Introduction

The HTP-240's and SKS-HT240's stylish enclosures are made of aluminum and their slim design makes them ideal for use with LCD and plasma TVs.

HTP-240

The HTP-240 is a 5.1-channel speaker package consisting of front left and right speakers, a center speaker, surround left and right speakers, and a powered subwoofer. It has been optimized for use with the Onkyo DR-S2.2 DVD Receiver, with which it will deliver superb surround sound playback.

Speaker terminals and speaker cables are color-coded for easy identification. Simply connect each speaker cable to the same-colored speaker terminals.









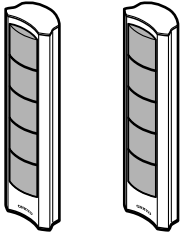

SKS-HT240

The SKS-HT240 is a 6.1-channel speaker package consisting of front left and right speakers, a center speaker, surround left and right speakers, a surround back speaker, and a powered subwoofer. Simply connect the speakers to your AV amp or receiver for superb surround sound playback.

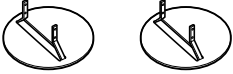
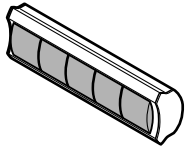

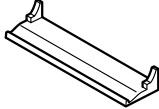
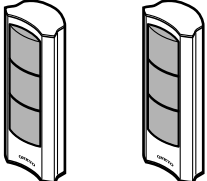
Speaker terminals and speaker cables are color-coded for easy identification. Simply connect each speaker cable to the same-colored speaker terminals.

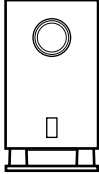
Package Contents

Make sure your box contains all of the items below. If anything is missing, contact the nearest Onkyo dealer.

- Front speakers (SKF-240F) 
- Speaker cable for front speakers 15 ft. (4.5 m) (Red)  (White) 
- Spacers for wall mounting [×20] (HTP-240 only) 
- Setup sheet (HTP-240 only)
- Front speaker base fixing screws [×8] 
- Front speaker bases 
- Center speaker (SKC-240C) 
- Speaker cable for center speaker 10 ft. (3 m) (Green) 
- Center speaker base 
- Surround speakers (SKM-240S) 
- Speaker cables for surround speakers 30 ft. (9 m) (Blue)  (Gray) 
- Subwoofer (SKW-240) 
- RCA cable for subwoofer connection 

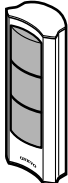
Items Supplied with SKS-HT240 Only

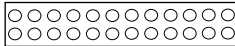
- Surround back speaker (SKB-240) 
- Speaker cable for surround back speaker 30 ft. (9 m) (Brown) 
- Spacers for wall mounting [×24] 

Getting to know Your Speaker Package

Subwoofer (SKW-240)

■ Front

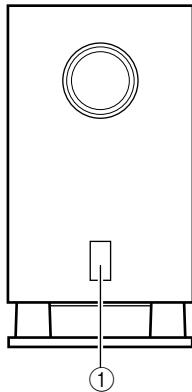

■ Rear

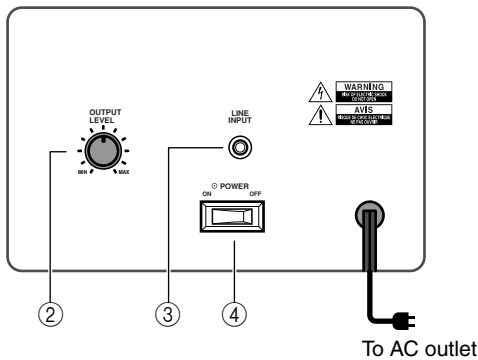

① **STANDBY/ON indicator**

Red: Subwoofer in standby mode
Green: Subwoofer on

With the Auto Standby function, the SKW-240 automatically turns on when an input signal is detected in Standby mode. When there's no input signal for a while, the SKW-240 automatically enters Standby mode.

② **OUTPUT LEVEL control**

This control is used to adjust the volume of the subwoofer.

③ **LINE INPUT**

This RCA input should be connected to the subwoofer preout on your DR-S2.2 DVD Receiver, amp, or other receiver with supplied RCA cable.

④ **POWER switch (not North American model)**

To turn on the SKW-240, set the POWER switch to the ON position (the indicator lights up).
To turn off the SKW-240, set the POWER switch to the OFF position (the indicator goes out).

Note:

The Auto Standby function turns the subwoofer on when the input signal exceeds a certain level. If the Auto Standby function does not work reliably, try slightly increasing or decreasing the subwoofer output level on your receiver or amp.

Front, Center & Surround Speakers (SKF-240F, SKC-240C, SKM-240S, SKB-240)

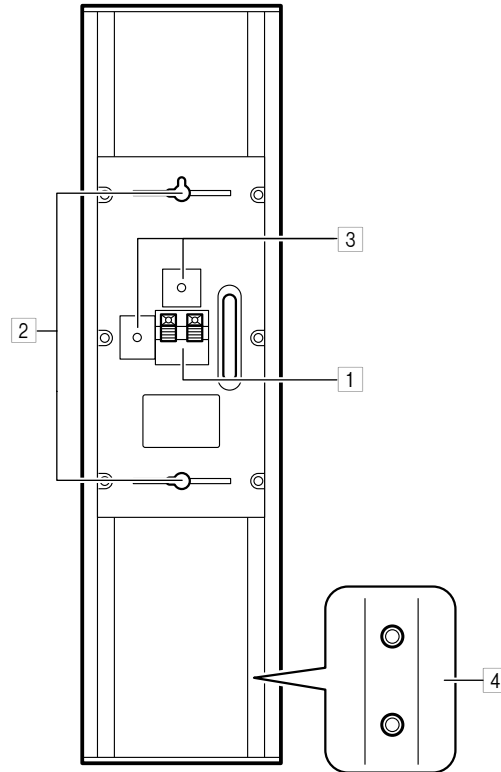

① **Speaker terminals**

These push terminals are for connecting the speaker to your DR-S2.2 DVD Receiver, amp, or other receiver with the supplied speaker cables. The supplied speaker cables are color-coded for easy identification. Simply connect each cable to the same-colored positive speaker terminal.

② **Keyhole slots**

These keyhole slots can be used to wall-mount the speaker either horizontally or vertically.

③ **Speaker mount/bracket inserts**

These threaded inserts can be used to attach the speaker either horizontally or vertically to a speaker mount or bracket.

Note:

Use commercially available M5 machine screws (1/4-inch screws for North American model) to attach the speaker to a speaker mount or bracket.

④ **Base inserts (other than center speaker)**

These threaded inserts can be used to mount the speaker on the supplied base (screws included).

Various Mounting Methods

Front Speaker Bases

If you intend to stand the front speakers on the floor or on a TV stand or AV stand, you should attach the supplied front speaker bases. To do this, align the mounting holes in the base with base inserts on the front speaker's rear panel, and secure by using four of the supplied fixing screws.

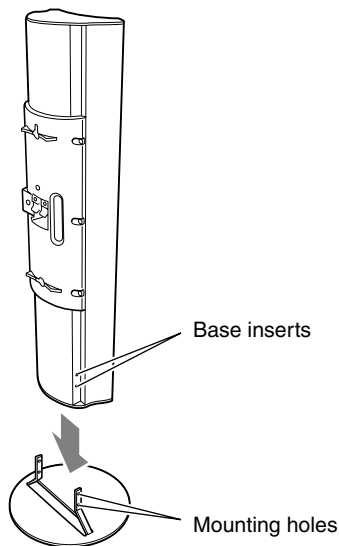

Center Speaker Base

The center speaker base is for mounting the center speaker horizontally. If you put it on a TV stand or AV stand, aim it toward the listening position. The center speaker should sit securely on the base. If it's loose, try resetting it.

Note:

- If you put the center speaker on the floor, take it off the base and position it so that it's facing slightly up toward the listener's ears.

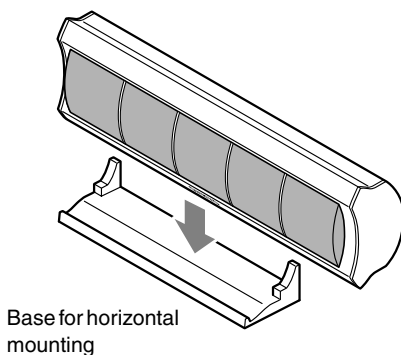

Wall Mounting

The front speakers, center speaker, surround speakers, and surround back speaker (SKS-HT240 only) can easily be wall mounted by using the keyhole slots. To prevent the speaker from vibrating against the wall, attach four of the supplied spacers to the keyhole fins on the rear of each speaker.

■ **Mounting vertically**

To mount the front speakers, surround speakers, or surround back speaker (SKS-HT240 only) vertically, use the keyhole slot shown to hang each speaker on a screw that's securely screwed into the wall.

Front speaker

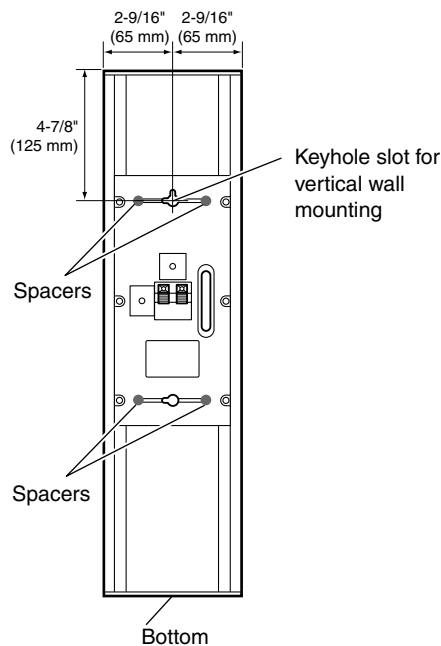

Surround/Surround Back speaker

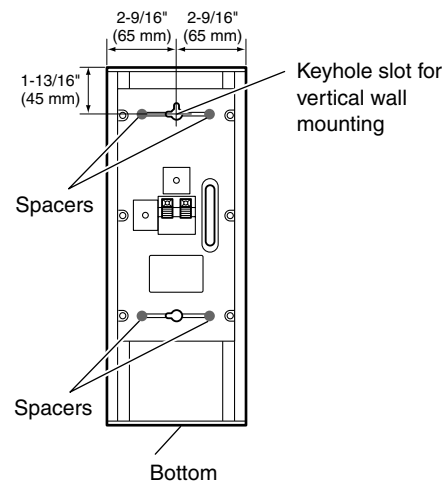

Various Mounting Methods—Continued

■ Mounting horizontally

To mount the center speaker horizontally, use the two keyhole slots shown below to hang it on two screws that are securely screwed into the wall.

Center speaker

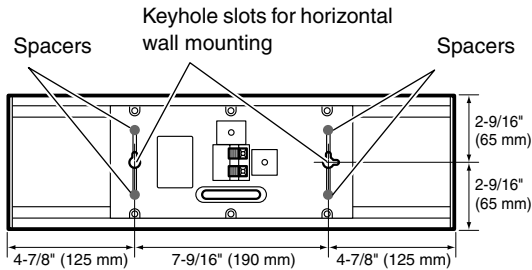

Caution:

A mounting screw's ability to support a speaker depends on how well it's anchored to the wall. If you have hollow walls, screw each mounting screw into a stud. If there are no studs, or the walls are solid, use suitable wall anchors. Use screws with a head diameter of 3/8 inch (9.5 mm) or less and a shank diameter of 1/8 inch (or 4 mm) or less (No. 8 or smaller). With hollow walls, use a cable/pipe detector to check for any power cables or water pipes before making any holes.

Leave a gap of between 9/32" (7 mm) and 13/32" (10 mm) between the wall and the base of the screw head, as shown.

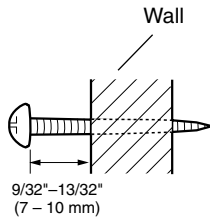

(We recommend that you consult a home installation professional.)

Using Speaker Mounts/Brackets

Threaded inserts for M5 machine screws (1/4-inch screws for North American model) are provided on the rear of each speaker for wall-mounting with commercially available speaker mounts and brackets. Refer to the manual supplied with your mounts or brackets for installation details.

Use this hole if mounting vertically

Use this hole if mounting horizontally

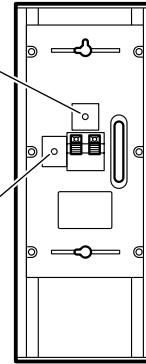

Note:

The portion of the screw that goes into the speaker's threaded insert should be between 1/5" and 3/8" of an inch long (5 mm and 9 mm).

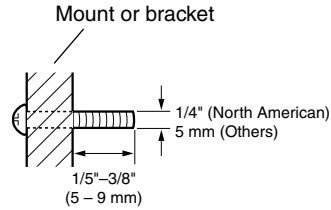

Connecting the Speakers

Read the following before connecting your speakers:

- Turn off your amp before making any connections.
- The nominal impedance of these speakers is 8 Ω. Use only an amp that supports this impedance.
- Pay close attention to speaker wiring polarity. Connect positive (+) terminals to only positive (+) terminals, and negative (–) terminals to only negative (–) terminals. If the speakers are wired incorrectly, the sound will be out of phase and will sound unnatural.
- Be careful not to short the positive and negative wires. Doing so may damage your amp.

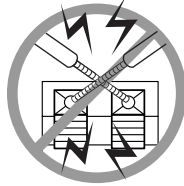

Connecting the Speaker Cables

1 Use the cables to connect each speaker's input terminals to the corresponding speaker output terminals on your amp.

To make a connection, while pressing the terminal lever, insert the wire into the hole, and then release the lever.

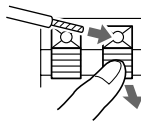

Make sure that the terminals are gripping the bare wires, not the insulation.

Tip:

Speaker terminal (+)	Color
Front left	White
Front right	Red
Center	Green
Surround left	Blue
Surround right	Gray
Surround back (SKS-HT240 only)	Brown

Connecting the Subwoofer

1 Using the supplied RCA cable, connect the subwoofer's LINE INPUT to your amp's SUBWOOFER PREOUT.

HTP-240 & DR-S2.2 Receiver Hookup

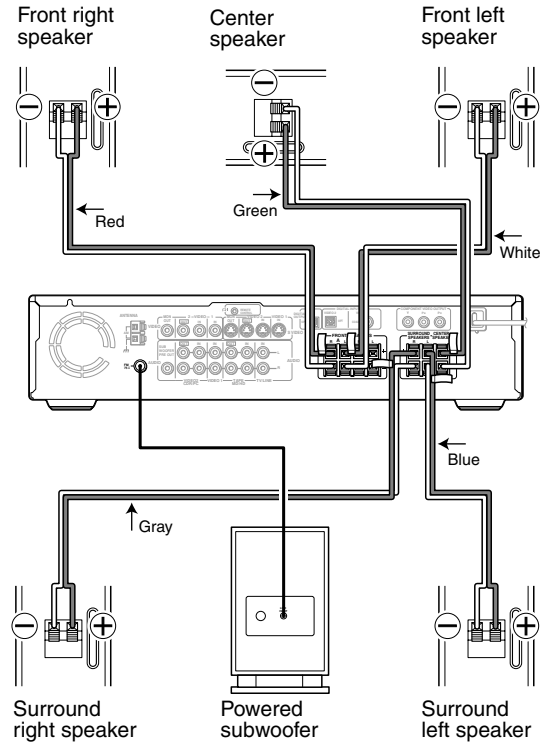

SKS-HT240 & 6-channel AV Amp Hookup

Onkyo AV receiver used in this example.

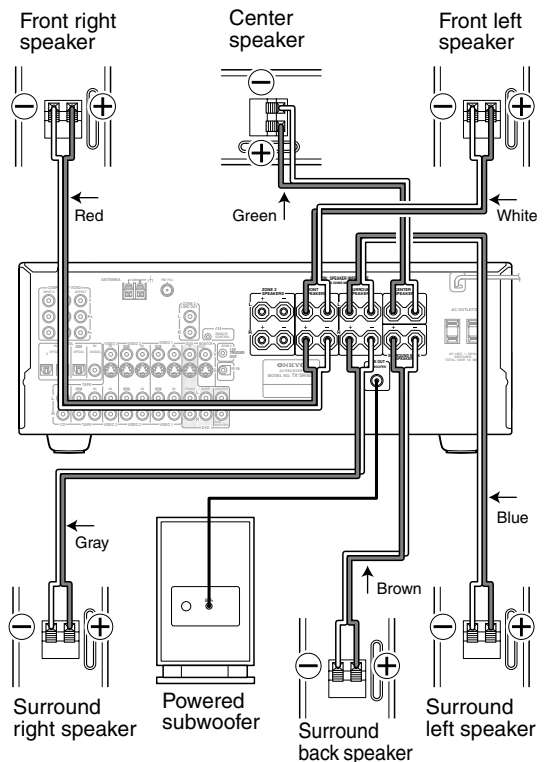

About Home Theater

Enjoying Home Theater

The HTP-240/SKS-HT240's great sound means that you can enjoy surround sound with a real sense of movement in your own home—just like being in a movie theater or concert hall.

Center speaker

This speaker enhances the front left and right speakers, making sound movements distinct and providing a full sound image. In movies it's used mainly for dialog.

Position it close to your TV facing forward at about ear level, or at the same height as the front left and right speakers.

Front left and right speakers

These output the overall sound. Their role in a home theater is to provide a solid anchor for the sound image. They should be positioned facing the listener at about ear level, and equidistant from the TV. Angle them inward so as to create a triangle, with the listener at the apex.

Subwoofer

The subwoofer handles the bass sounds of the LFE (Low-Frequency Effects) channel. The volume and quality of the bass output from your subwoofer will depend on its position, the shape of your listening room, and your listening position. In general, a good bass sound can be obtained by installing the subwoofer in a front corner, or at one-third the width of the wall, as shown.

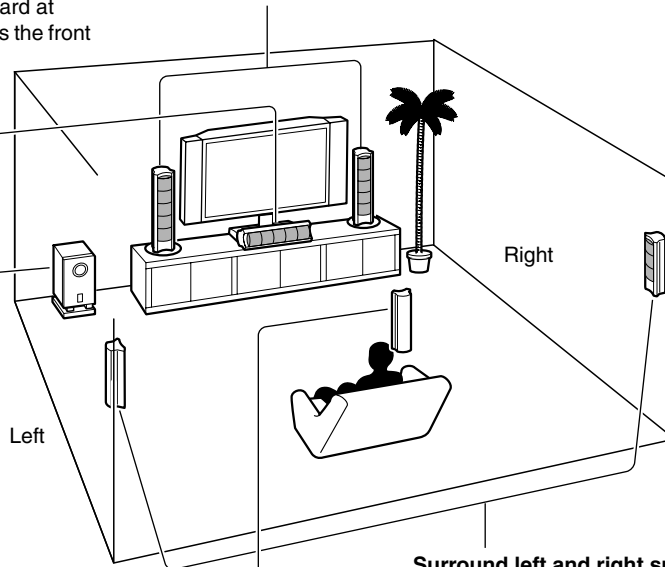
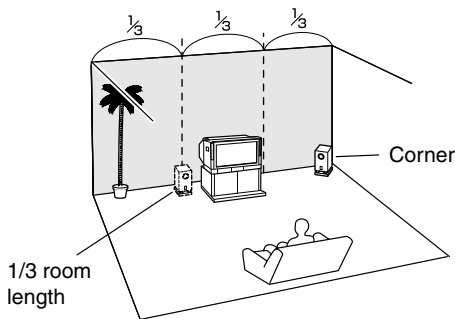

Surround left and right speakers

These speakers are used for precise sound positioning and to add realistic ambience. Position them at the sides of the listener, or slightly behind, about 2–3 feet (60–100 cm) above ear level. Ideally they should be equidistant from the listener.

Surround back speaker (SKS-HT240 only)

This speaker further enhances the realism of surround sound and improves sound localization behind the listener. The surround-back speaker should be installed behind the listener also at 2–3 ft. (60–100 cm) above ear level.

Adjustment

Setting the Subwoofer Level

To set the level of the subwoofer, use the OUTPUT LEVEL control. Set it so that bass sounds are evenly balanced with the treble sounds from the other speakers. Because our ears are less sensitive to very low bass sounds, there's a temptation to set the level of the subwoofer too high. As a rule of thumb, set the subwoofer level to what you think is the optimal level, and then back it off slightly.

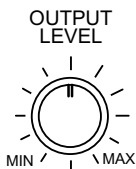

Subwoofer Level Set OK

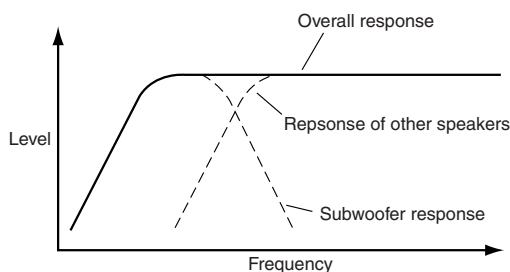

Subwoofer Level Set Incorrectly

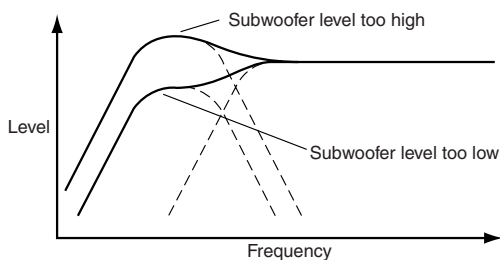

Caring for Your Speakers

Placement

- The speaker cabinets are made out of aluminum and are therefore sensitive to extreme temperatures and humidity, do not put them in locations subject to direct sunlight or in humid places, such as near an air conditioner, humidifier, bathroom, or kitchen.
- Do not put water or other liquids close to the speakers. If liquid is spilled over the speakers, the drive units may be damaged.
- As explained in this manual, mount the speakers on a wall, on the supplied bases, otherwise, they may fall, causing personal injury or damage to the speakers.
- Speakers with bases should only be placed on sturdy, flat surfaces that are free from vibration. Putting them on uneven or unstable surfaces, where they may fall and cause damage, will affect the sound quality.

Using Close to a TV or Computer

TVs and computer monitors are magnetically sensitive devices and as such are likely to suffer discoloration or picture distortion when conventional speakers are placed nearby. To prevent this, speakers other than the subwoofer feature internal magnetic shielding. In some situations, however, discoloration may still be an issue, in which case you should turn off your TV or monitor, wait 15 to 30 minutes, and then turn it back on again. This normally activates the degaussing function, which neutralizes the magnetic field, thereby removing any discoloration effects. If discoloration problems persist, try moving the speakers away from your TV or monitor. Note that discoloration can also be caused by a magnet or demagnetizing tool that's too close to your TV or monitor.

Operating Precautions

The HTP-240/SKS-HT240 speakers can handle the specified input power when used for normal music reproduction. If any of the following signals are fed to them, even if the input power is within the specified rating, excessive current may flow in the speaker coils, causing burning or wire breakage:

1. Interstation noise from an untuned FM radio.
2. Sound from fast-forwarding a cassette tape.
3. High-pitched sounds generated by an oscillator, electronic musical instrument, and so on.
4. Amplifier oscillation.
5. Special test tones from audio test CDs and so on.
6. Thumps and clicks caused by connecting or disconnecting audio cables (Always turn off your amplifier before connecting or disconnecting cables.)
7. Microphone feedback.

Troubleshooting

Symptom	Possible cause	Remedy
There's no sound coming from certain speakers?	The speaker cables are not connected properly.	Check the speaker cables and correct as necessary.
	HTP-240: The number of speaker channels is not set to 5ch on the DR-S2.2.	Set the number of speaker channels to 5ch.
	SKS-HT240: On the amp or receiver, the Speaker Configuration settings for those speakers are set to either None or No. Or, the number of speaker channels is not set to 6ch.	Check the Speaker Configuration settings and make sure that the speakers are set to something other than None or No. Or set the number of speaker channels to 6ch.
The subwoofer does not turn on?	The power plug is not fully inserted into the wall outlet.	Insert the power plug fully into the wall outlet.
The subwoofer produces no sound?	The OUTPUT LEVEL control is set to minimum.	Turn up the OUTPUT LEVEL control.
	The RCA cable is not properly connected to the subwoofer's LINE INPUT.	Make sure that the RCA cable is properly connected to the subwoofer's LINE INPUT.
	The level of the input signal was too low and the subwoofer entered Standby mode.	Slightly increase the subwoofer preout output level on your amp.
	HTP-240: On the DR-S2.2 Receiver, the subwoofer mode is set to SW Off.	Set the subwoofer mode to something other than SW Off.
	SKS-HT240: On your amp or receiver, the speaker setting is set to Subwoofer No, or the subwoofer mode is set to Subwoofer Off.	Check the settings on your amp or receiver.
The subwoofer produces hardly any sound?	The source material contain little or no bass content.	Choose source material with more bass content.
A humming sound can be heard from the subwoofer?	The RCA cable is not properly connected to the subwoofer's LINE INPUT.	Make sure that the RCA cable is properly connected to the subwoofer's LINE INPUT.
	External interference from a TV or other electronic device is being picked up.	Move the subwoofer and RCA cable away from the interference source. Make sure your audio system is grounded properly.

Specifications

■ Powered Subwoofer (SKW-240)

Type:	Bass reflex with built-in power amplifier
Input sensitivity/impedance:	220 mV / 15 kΩ
Maximum output power:	150 W Dynamic
Frequency response:	27 Hz–150 Hz
SN ratio:	70 dB
Cabinet capacity:	1.36 cubic feet (38.5 L)
Dimensions (W × H × D):	10-13/16" × 20-3/8" × 16-3/16" (275 × 518 × 411 mm)
Weight:	30.9 lbs. (14 kg)
Drive unit:	8" (20 cm) cone woofer
Power supply:	North American model: AC 120 V, 60 Hz Others: AC 230–240 V, 50 Hz
Power consumption:	North American model: 75 W Others: 77 W
Other:	Auto Standby function

■ Front Speaker (SKF-240F)

Type:	2-way bass reflex front speaker
Impedance:	8 Ω
Maximum input power:	100 W
Output sound pressure level:	82 dB/W/m
Frequency response:	55 Hz–35 kHz
Crossover frequency:	5 kHz
Cabinet capacity:	0.11 cubic feet (3 L)
Dimensions (W × H × D):	5-1/8" × 19-11/16" × 3-9/16" (130 × 500 × 91 mm)
Weight:	5.5 lbs. (2.5 kg)
Drive unit:	3-1/8" (8 cm) cone woofer × 2 1" (2.5 cm) balanced-dome tweeter
Other:	Magnetic shielding

Specifications—Continued

■ Center Speaker (SKC-240C)

Type:	2-way bass reflex center speaker
Impedance:	8 Ω
Maximum input power:	100 W
Output sound pressure level:	82 dB/W/m
Frequency response:	65 Hz–35 kHz
Crossover frequency:	5 kHz
Cabinet capacity:	0.09 cubic feet (2.6 L)
Dimensions (W × H × D):	17-5/16" × 5-1/8" × 3-9/16" (439 × 130 × 91 mm)
Weight:	5.1 lbs. (2.3 kg)
Speaker:	3-1/8" (8 cm) cone woofer × 2 1" (2.5 cm) balanced- dome tweeter
Other:	Magnetic shielding

■ Surround Speaker (SKM-240S/SKB-240)

Type:	2-way bass reflex surround/surround back speaker
Impedance:	8 Ω
Maximum input power:	100 W
Output sound pressure level:	80 dB/W/m
Frequency response:	65 Hz–35 kHz
Crossover frequency:	6.5 kHz
Cabinet capacity:	0.07 cubic feet (2 L)
Dimensions (W × H × D):	5-1/8" × 13-3/8" × 3-9/16" (130 × 340 × 91 mm)
Weight:	3.5 lbs. (1.6 kg)
Speaker:	3-1/8" (8 cm) cone woofer 1" (2.5 cm) balanced- dome tweeter
Other:	Magnetic shielding

Specifications and appearance are subject to change without prior notice.

ONKYO CORPORATION

Sales & Product Planning Div. : 2-1, Nisshin-cho, Neyagawa-shi, OSAKA 572-8540, JAPAN
Tel: 072-831-8023 Fax: 072-831-8124

ONKYO U.S.A. CORPORATION

18 Park Way, Upper Saddle River, N.J. 07458, U.S.A.
Tel: 201-785-2600 Fax: 201-785-2650 <http://www.us.onkyo.com/>

ONKYO EUROPE ELECTRONICS GmbH

Liegnitzerstrasse 6, 82194 Groebenzell, GERMANY
Tel: +49-8142-4401-0 Fax: +49-8142-4401-555 <http://www.eu.onkyo.com/>

ONKYO EUROPE UK Office

Suite 1, Gregories Court, Gregories Road, Beaconsfield, Buckinghamshire, HP9 1HQ
UNITED KINGDOM Tel: +44-(0)1494-681515 Fax: +44(0)-1494-680452

ONKYO CHINA LIMITED

Units 2102-2107, Metroplaza Tower I, 223 Hing Fong Road, Kwai Chung,
N.T., HONG KONG Tel: 852-2429-3118 Fax: 852-2428-9039
<http://www.ch.onkyo.com/>



10504-4

SN 29343622C

(C) Copyright 2005 ONKYO CORPORATION Japan. All rights reserved.

