

ONKYO®

AV Surround Processor

ED-205

Instruction Manual

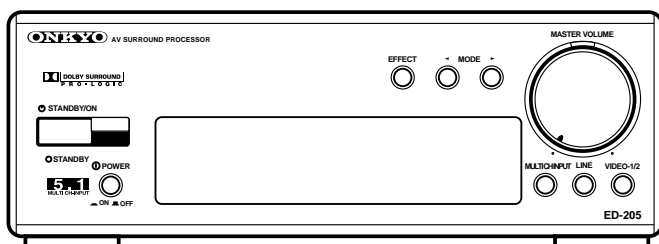

Thank you for purchasing the ONKYO AV Surround Processor.

Please read this manual thoroughly before making connections and turning on the power.

Following the instructions in this manual will enable you to obtain optimum performance and listening enjoyment from your new AV Surround Processor.

Please retain this manual for future reference.

Contents

Before using

Important Safeguards	2
Precautions	3
Features	4
Supplied accessories	4
Before using this unit	5

Preparation

Connecting the amplifier and video equipment	6
Connecting equipment with 5.1-channel audio output	7
Speaker placement and connection	8
Connecting the RI remote control cables	10
Connecting the power	10

Operation

Using the remote controller	11
Using the Surround modes	12
Playing a source	14

A few important notes

Troubleshooting	17
Control positions and names	18
Specifications	20

WARNING:

TO REDUCE THE RISK OF FIRE OR ELECTRIC SHOCK, DO NOT EXPOSE THIS APPLIANCE TO RAIN OR MOISTURE.

CAUTION:

TO REDUCE THE RISK OF ELECTRIC SHOCK, DO NOT REMOVE COVER (OR BACK). NO USER-SERVICEABLE PARTS INSIDE. REFER SERVICING TO QUALIFIED SERVICE PERSONNEL.



WARNING
RISK OF ELECTRIC SHOCK
DO NOT OPEN

AVIS
RISQUE DE CHOC ELECTRIQUE
NE PAS OUVRIR



The lightning flash with arrowhead symbol, within an equilateral triangle, is intended to alert the user to the presence of uninsulated "dangerous voltage" within the product's enclosure that may be of sufficient magnitude to constitute a risk of electric shock to persons.



The exclamation point within an equilateral triangle is intended to alert the user to the presence of important operating and maintenance (servicing) instructions in the literature accompanying the appliance.

Important Safeguards

1. **Read Instructions** – All the safety and operating instructions should be read before the appliance is operated.
 2. **Retain Instructions** – The safety and operating instructions should be retained for future reference.
 3. **Heed Warnings** – All warnings on the appliance and in the operating instructions should be adhered to.
 4. **Follow Instructions** – All operating and use instructions should be followed.
 5. **Water and Moisture** – The appliance should not be used near water – for example, near a bathtub, washbowl, kitchen sink, laundry tub, in a wet basement, or near a swimming pool, and the like.
 6. **Carts and Stands** – The appliance should be used only with a cart or stand that is recommended by the manufacturer.
- PORTABLE CART WARNING

S3125A
- 6A. An appliance and cart combination should be moved with care. Quick stops, excessive force, and uneven surfaces may cause the appliance and cart combination to overturn.
 7. **Wall or Ceiling Mounting** – The appliance should be mounted to a wall or ceiling only as recommended by the manufacturer.
 8. **Ventilation** – The appliance should be situated so that its location or position does not interfere with its proper ventilation. For example, the appliance should not be situated on a bed, sofa, rug, or similar surface that may block the ventilation openings; or if placed in a built-in installation, such as a bookcase or cabinet that may impede the flow of air through the ventilation openings, there should be free space of at least 20 cm (8 in.) and an opening behind the appliance.
 9. **Heat** – The appliance should be situated away from heat sources such as radiators, heat registers, stoves, or other appliances (including amplifiers) that produce heat.
 10. **Power Sources** – The appliance should be connected to a power supply only of the type described in the operating instructions or as marked on the appliance.
 11. **Polarization** – If the appliance is provided with a polarized plug having one blade wider than the other, please read the following information:
The polarization of the plug is a safety feature. The polarized plug will only fit the outlet one way. If the plug does not fit fully into the outlet, try reversing it. If there is still trouble, the user should seek the services of a qualified electrician. Under no circumstances should the user attempt to defeat the polarization of the plug.
 12. **Power-Cord Protection** – Power-supply cords should be routed so that they are not likely to be walked on or pinched by items placed upon or against them, especially near plugs, convenience receptacles, and the point where they exit from the appliance.
 13. **Cleaning** – The appliance should be cleaned only as recommended by the manufacturer.
 14. **Nonuse Periods** – The power cord of the appliance should be unplugged from the outlet when left unused for a long period of time.
 15. **Object and Liquid Entry** – Care should be taken so that objects do not fall and liquids are not spilled into the enclosure through openings.
 16. **Damage Requiring Service** – The appliance should be serviced by qualified service personnel when:
 - A. The power-supply cord or the plug has been damaged; or
 - B. Objects have fallen, or liquid has been spilled into the appliance; or
 - C. The appliance has been exposed to rain; or
 - D. The appliance does not appear to operate normally or exhibits a marked change in performance; or
 - E. The appliance has been dropped, or the enclosure damaged.
 17. **Servicing** – The user should not attempt to service the appliance beyond that described in the operating instructions. All other servicing should be referred to qualified service personnel.

Precautions

1. Warranty Claim

You can find the serial number on the rear panel of this unit. In case of warranty claim, please report this number.

2. Recording Copyright

Recording of copyrighted material for other than personal use is illegal without permission of the copyright holder.

3. AC Fuse

The fuse is located inside the chassis and is not user-serviceable. If power does not come on, contact your Onkyo authorized service station.

4. Care

From time to time you should wipe the front and rear panels and the cabinet with a soft cloth. For heavier dirt, dampen a soft cloth in a weak solution of mild detergent and water, wring it out dry, and wipe off the dirt. Following this, dry immediately with a clean cloth. Do not use rough material, thinners, alcohol or other chemical solvents or cloths since these could damage the finish or remove the panel lettering.

5. Power

WARNING

BEFORE PLUGGING IN THE UNIT FOR THE FIRST TIME, READ THE FOLLOWING SECTION CAREFULLY.

The voltage of the available power supply differs according to country or region. Be sure that the power supply voltage of the area where this unit will be used meets the required voltage (e.g., AC 230 V, 50 Hz or AC 120 V, 60 Hz) written on the rear panel.

For British model

Replacement and mounting of an AC plug on the power supply cord of this unit should be performed only by qualified service personnel.

IMPORTANT

The wires in the mains lead are coloured in accordance with the following code:

Blue : Neutral

Brown : Live

As the colours of the wires in the mains lead of this apparatus may not correspond with the coloured markings identifying the terminals in your plug, proceed as follows:

The wire which is coloured blue must be connected to the terminal which is marked with the letter N or coloured black.

The wire which is coloured brown must be connected to the terminal which is marked with the letter L or coloured red.

IMPORTANT

A 5 amp fuse is fitted in this plug. Should the fuse need to be replaced, please ensure that the replacement fuse has a rating of 5 amps and that it is approved by ASTA or BSI to BS1362. Check for the ASTA mark or the BSI mark on the body of the fuse.

IF THE FITTED MOULDED PLUG IS UNSUITABLE FOR THE SOCKET OUTLET IN YOUR HOME THEN THE FUSE SHOULD BE REMOVED AND THE PLUG CUT OFF AND DISPOSED OF SAFELY. THERE IS A DANGER OF SEVERE ELECTRICAL SHOCK IF THE CUT OFF PLUG IS INSERTED INTO ANY 13 AMP SOCKET.

If in any doubt, please consult a qualified electrician.

For U.S. model

Note to CATV system installer:

This reminder is provided to call the CATV system installer's attention to Article 820-40 of the NEC, ANSI/NFPA 70, which provides guidelines for proper grounding and, in particular, specifies that the cable ground shall be connected to the grounding system of the building, as close to the point of cable entry as practical.

FCC Information for User

CAUTION:

The user changes or modifications not expressly approved by the party responsible for compliance could void the user's authority to operate the equipment.

NOTE:

This equipment has been tested and found to comply with the limits for a Class B digital device, pursuant to Part 15 of the FCC Rules. These limits are designed to provide reasonable protection against harmful interference in a residential installation. This equipment generates, uses and can radiate radio frequency energy and, if not installed and used in accordance with the instructions, may cause harmful interference to radio communications. However, there is no guarantee that interference will not occur in a particular installation. If this equipment does cause harmful interference to radio or television reception, which can be determined by turning the equipment off and on, the user is encouraged to try to correct the interference by one or more of the following measures:

- Reorient or relocate the receiving antenna.
- Increase the separation between the equipment and receiver.
- Connect the equipment into an outlet on a circuit different from that to which the receiver is connected.
- Consult the dealer or an experienced radio/TV technician for help.

For Canadian model

CAUTION: THIS DIGITAL APPARATUS DOES NOT EXCEED THE CLASS B LIMITS FOR RADIO NOISE EMISSION FROM DIGITAL APPARATUS SET OUT IN THE RADIO INTERFERENCE REGULATIONS OF THE CANADIAN DEPARTMENT OF COMMUNICATIONS.

For models having a power cord with a polarized plug:

CAUTION: TO PREVENT ELECTRIC SHOCK, MATCH WIDE BLADE OF PLUG TO WIDE SLOT, FULLY INSERT.

Modele pour les Canadiens

ATTENTION: L'INTERFERENCE RADIO ELECTRIQUE GENEREE PAR CET APPAREIL NUMERIQUE DE TYPE B NE DEPASSE PAS LES LIMITES ENONCEES DANS LE REGLEMENT SUR LES PERTURBATIONS RADIO ELECTRIQUES, SECTION APPAREIL NUMERIQUE, DU MINISTERE DES COMMUNICATIONS.

Sur les modeles dont la fiche est polarisee:

ATTENTION: POUR EVITER LES CHOCS ELECTRIQUES, INTRODUIRE LA LAME LA PLUS LARGE DE LA FICHE DANS LA BORNE CORRESPONDANTE DE LA PRISE ET POUSSER JUSQU'AU FOND.

Declaration of Conformity

We, ONKYO EUROPE
ELECTRONICS GmbH
INDUSTRIESTRASSE 20
82110 GERMERING,
GERMANY



declare in own responsibility, that the ONKYO product described in this instruction manual is in compliance with the corresponding technical standards such as EN55013, EN55020, EN61000-3-2, -3-3 (or EN60555-2, -3) and EN60065

GERMERING, GERMANY

K.OTSU

ONKYO EUROPE ELECTRONICS GmbH

Features

- Compact, high-quality component design
- Dolby* Pro Logic decoder with 3 surround modes (Hall, Live, and Arena) and Stereo mode
- Superb expandability with 5.1-channel input
- Flexible connectivity with Separate Collection Series components
- S-video connector
- System control with supplied remote controller

* Manufactured under license from Dolby Laboratories. "Dolby", "Pro Logic" and the double-D symbol  are trademarks of Dolby Laboratories. Confidential Unpublished Works. ©1992-1997 Dolby Laboratories, Inc. All rights reserved.

Supplied accessories

Check that the following accessories are supplied with your ED-205.

- Audio connection cable X 2

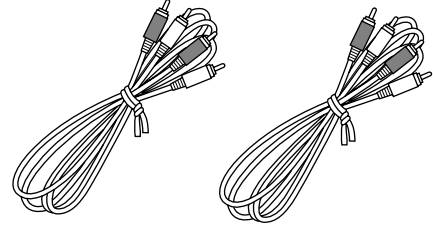

- RI cable X 1

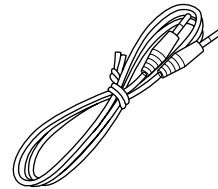

- Remote controller X 1
Batteries (size AA, R6, or UM-3) X 2



Memory Preservation

This unit does not require memory preservation batteries. A built-in memory power back-up system preserves the contents of the memory during power failures and even when the unit is unplugged. The unit must be plugged in order to charge the back-up system.

The memory preservation period after the unit has been unplugged varies depending on climate and placement of the unit. On the average, memory contents are protected over a period of a few weeks after the last time the unit has been unplugged. This period is shorter when the unit is exposed to a highly humid climate.

Before operating this unit

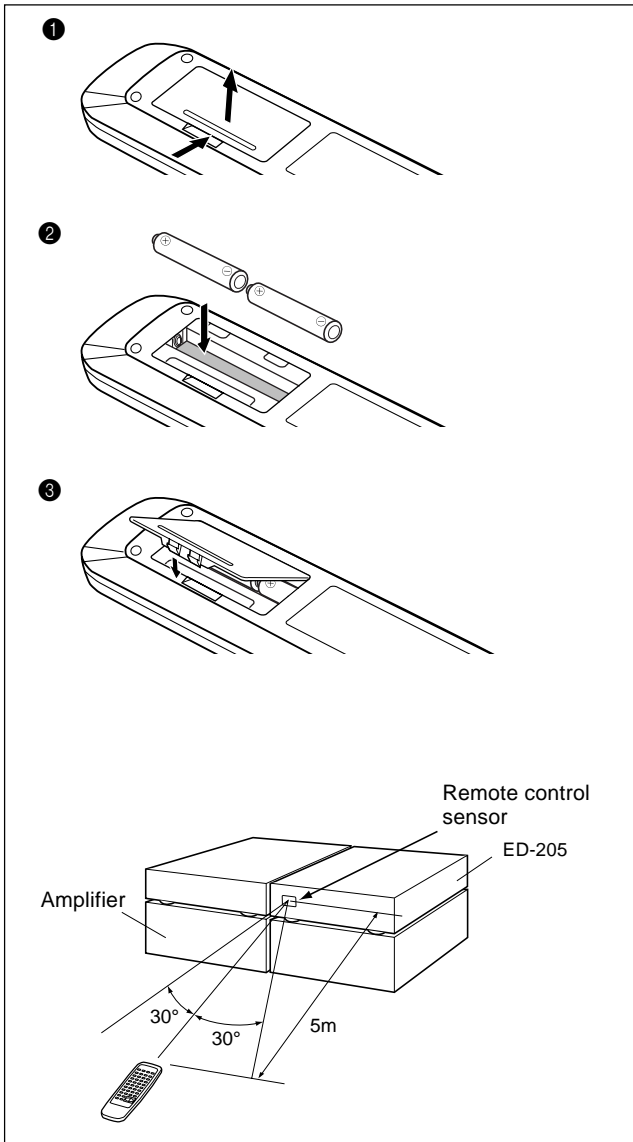

Installing the remote controller batteries

- 1 Remove the battery compartment cover by pressing the tab and lifting up the cover.
- 2 Insert two AA (R6- or UM-3)-size batteries into the battery compartment. Carefully follow the polarity diagram (positive (+) and negative (-) symbols) inside the battery compartment.
- 3 After batteries are installed and seated correctly, replace the compartment cover.

Notes:

- Do not mix new batteries with old batteries or different kinds of batteries.
- To avoid corrosion, remove the batteries if the remote controller is not to be used for a long time.
- Remove dead batteries immediately to avoid damage from corrosion. If the remote controller doesn't operate smoothly, replace both the batteries at the same time.
- The life of the batteries supplied is about six months but this will vary depending on usage.

Using the remote controller

Point the remote controller toward the remote control sensor.

Notes:

- Place the unit away from strong light such as direct sunlight or inverted fluorescent light which can prevent proper operation of the remote controller.
- Using another remote controller of the same type in the same room or using the unit near equipment which uses infrared rays may cause operational interference.
- Do not put any object such as a book on the remote controller. The buttons of the remote controller may be pressed by mistake and drain the batteries.
- Make sure the audio rack doors do not have colored glass. Placing the unit behind such doors may prevent proper remote controller operation.
- If there is any obstacle between the remote controller and the remote control sensor, the remote controller will not operate.

Connecting the amplifier and video equipment

- Do not connect the power cord until you complete all other connections.
- Connect the unit to your amplifier via the supplied audio connection cables. Be sure to insert the cable's red plugs into the Right jacks and white plugs into the Left jacks.
For other connections, use the cables that came with that equipment.
- Insert the plugs and connectors completely. Remember that improper connection results in noise or malfunction.
- Do not bind the audio connection cables with the power cord and speaker cables. Doing so may degrade sound quality.
- The unit's cover will become hot due to its built-in amplifier. Avoid placing any equipment on the unit.

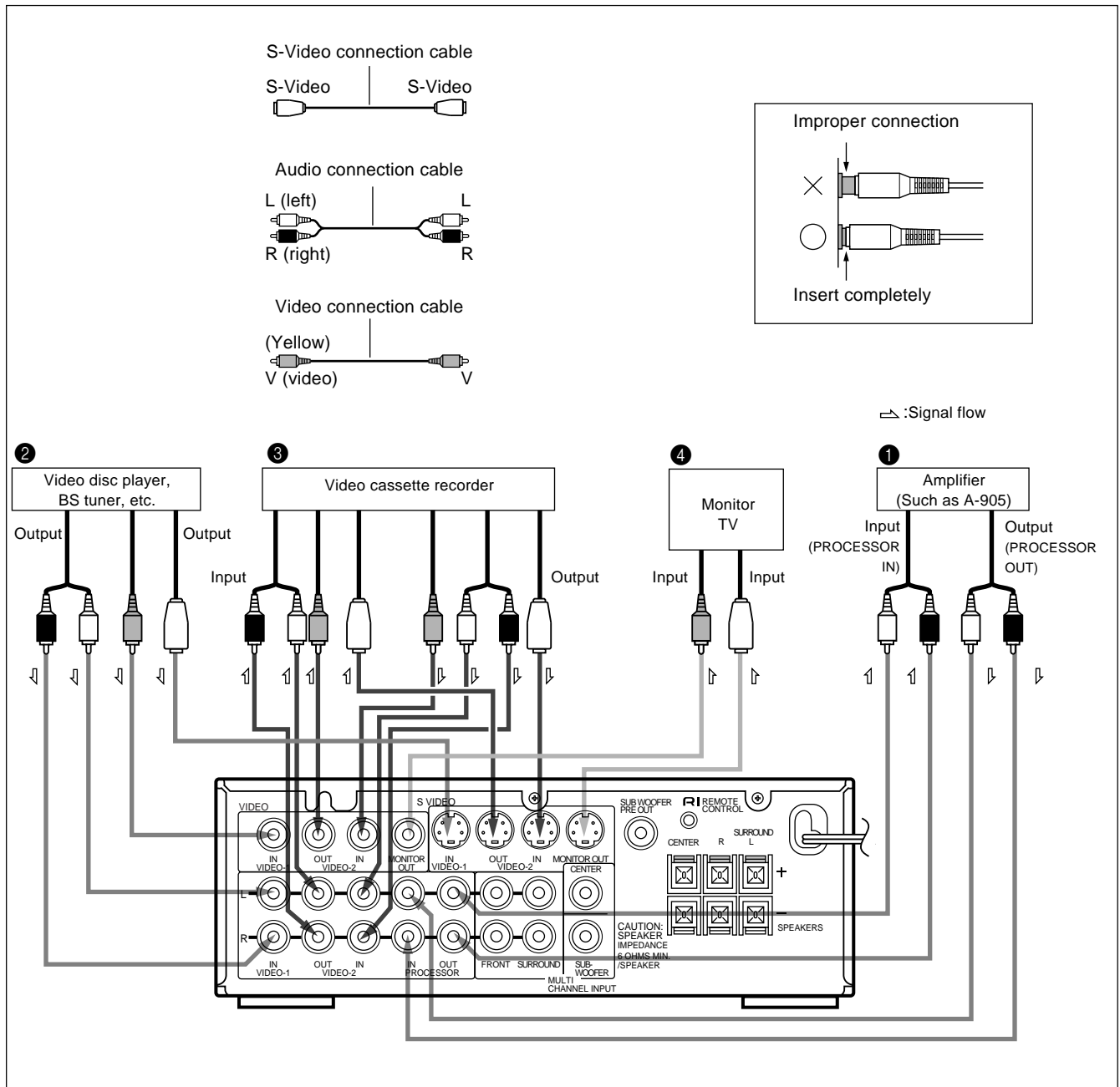

1 Connecting the amplifier

Connect the amplifier's processor connection jacks to the ED-205's PROCESSOR IN/OUT jacks.
With an Onkyo amplifier such as A-905, remove the jumper plug in the processor jack before connecting the audio connection cables. The removed jumper plug should be kept for future use. Never attempt to insert the jumper plug into any other jacks.

2 Connecting a video disc player or BS tuner

Connect the equipment's Video output jacks to the ED-205's VIDEO-1 jacks.

3 Connecting a video cassette recorder

Connect the video cassette recorder's Video jacks to the ED-205's VIDEO-2 jacks.

4 Connecting a TV monitor

Connect the TV monitor's Video input jack to the ED-205's Video or S VIDEO MONITOR OUT jack.

Note:

This unit's S VIDEO IN/OUT jacks do not have an S-Video/Video switching feature. Be sure to connect your video cassette recorder via either the Video or S-Video connection cable.

Connecting equipment with 5.1-channel audio output

Connecting equipment with 5.1-channel audio output (such as a DVD player)

Connect the equipment's 5.1-channel output jacks to the ED-205's MULTI CHANNEL INPUT jacks.
The equipment's 2-channel audio output jacks should be connected to the amplifier such as A-905 's LINE-1 jacks.
The equipment's Video output jack should be connected to the ED-205's VIDEO-1 IN jack.

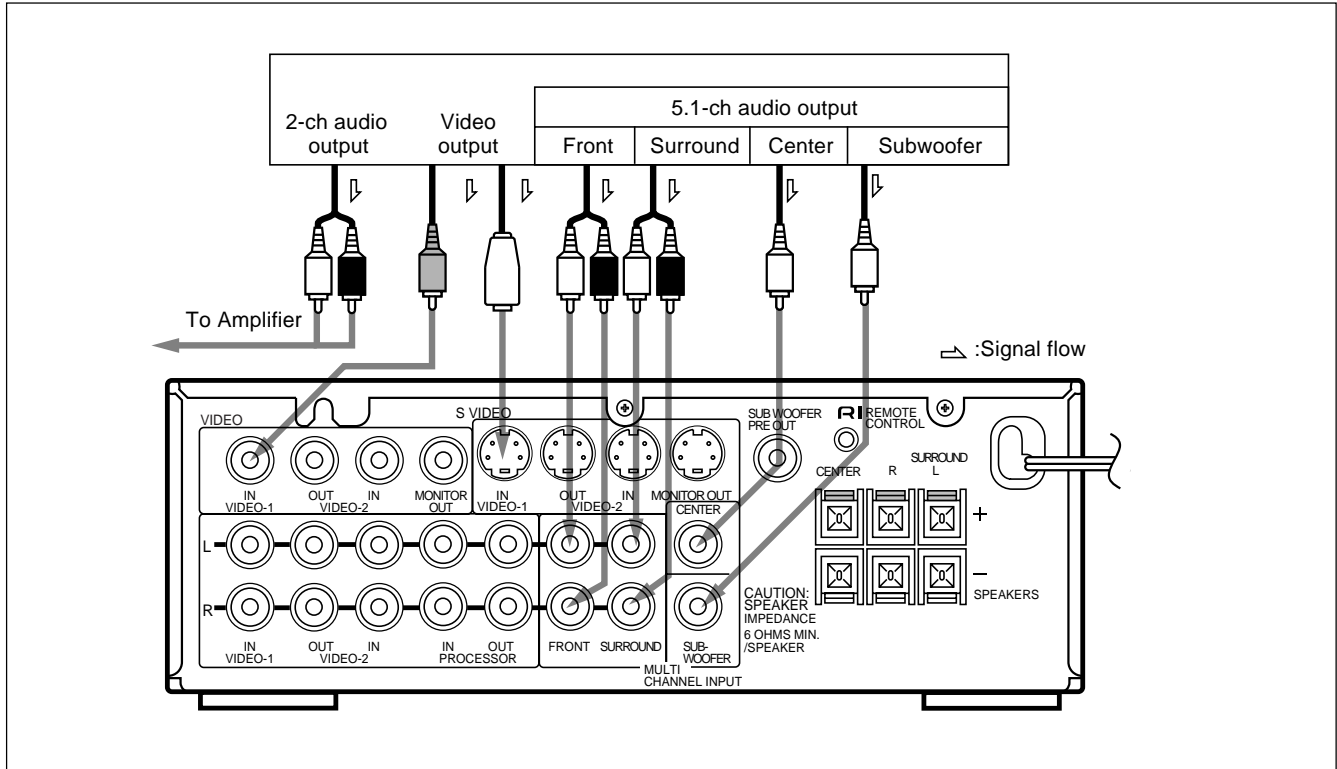

Speaker placement and connection

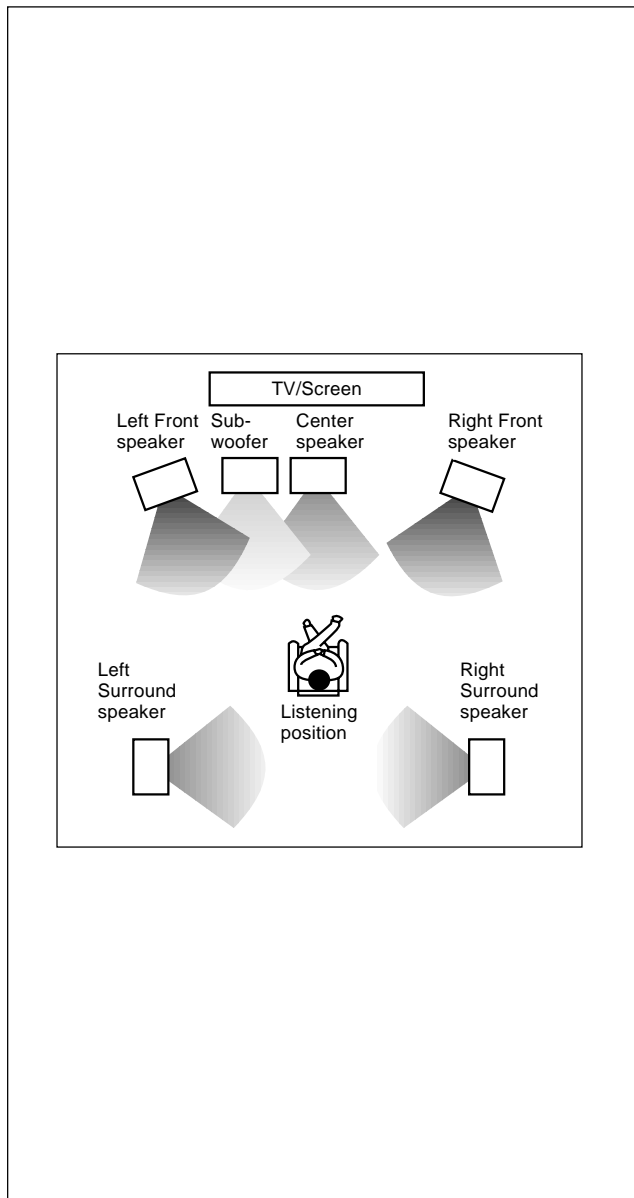

The unit is equipped with speaker terminals for connecting the Center speaker and Surround speakers, in addition to the SUBWOOFER PRE OUT jack to allow connection to your Subwoofer.

Use the ED-205's SUBWOOFER PRE OUT jack to connect your Subwoofer, even if your amplifier also has a subwoofer connection jack.

Connect the Left and Right front speakers to your amplifier's speaker terminals.

Speaker placement

In this section, only one example of possible speaker placement is shown. Note, however, that ideal speaker placement varies depending on the size of the room and the wall coverings used in the room. To obtain ideal sound field effects, the Left and Right front speakers must be placed at equal distances from the listening position.

Important Points

- **Left and Right front speakers (L/R) and Center speaker (C)**

Place these three speakers at the same height from the floor. Place each speaker so that sound is aimed at the audience's ears at the listening position.

- **Left and Right Surround speakers (LS/RS)**

Place these speakers so that their height is 1 meter (3 feet) higher than that of the audience's ears.

- **Subwoofer (SW)**

Place it anywhere in your listening room that produces satisfactory sound. The placement of the Subwoofer affects the perceived direction of the sound very little, but optimal bass reproduction will be achieved with placement in a corner.

If your speaker system lacks Subwoofer, Center speaker, or Surround speakers

To get the highest-quality surround sound from the ED-205, you need a complete set of 6 speakers. However, you can enjoy quality surround sound by setting the ED-205 to properly distribute the sound originally intended for these non-existing speakers to existing front and surround speakers, even if your system lacks the subwoofer, center speaker, or surround speakers.

Connecting the speaker cables

- 1 Peel the insulation off the ends of the speaker cable 15 mm. Do not cut core wires.
- 2 Twist the core wires.
- 3 Press the lever below the speaker terminal to open the connection hole.
- 4 Insert the core wires into connection hole.
- 5 Return the lever to the original position. Make sure that the core wires are barely visible where they enter the connection hole.

Notes:

- Be sure to connect the Right and Left speakers to the unit's corresponding speaker terminals. Also, be sure that you are connecting the speaker's positive (+) and negative (-) binding posts with unit's corresponding speaker terminals. Otherwise, inferior sound will result.
- Use speakers whose nominal impedance is 6 to 16Ω. Connecting a speaker whose impedance is lower than 6Ω may cause damage to the unit.
- Do not connect two or more speaker cables to the same speaker terminal. Doing so may cause damage to the unit.
- To prevent damage to the circuitry, never short-circuit the positive (+) and negative (-) speaker wires by allowing them to touch each other.

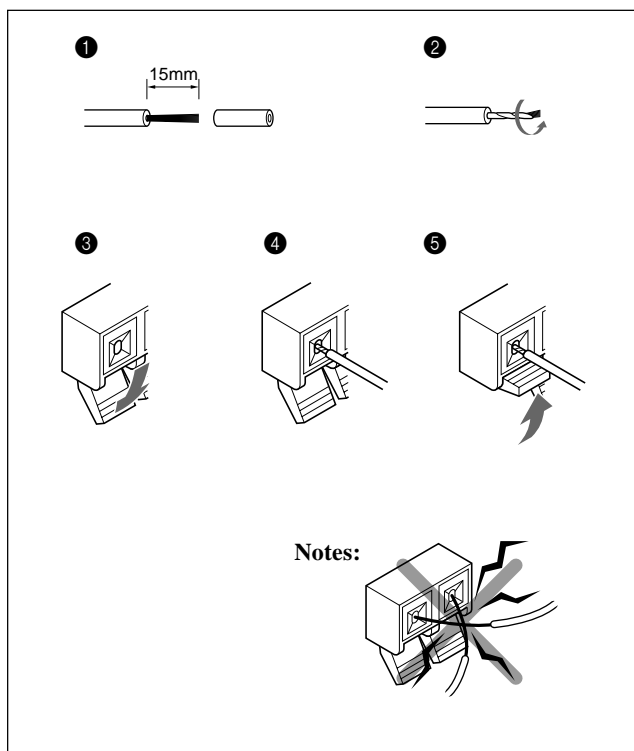

Speaker placement and connection

- Follow the diagram below to connect each speaker as illustrated, observing the correct connections for R, L, + and -.
- Do not use unnecessarily long or extremely thin speaker cables. If the DC resistance of the speaker cables is too high, the damping factor will decrease, adversely affecting the sound quality.

Speaker Impedance

This unit is designed to produce optimum sound quality when speakers with impedances within the specified ranges are connected. Please check the following information and choose speakers with the necessary impedances for the connections.

- CENTER SPEAKER** : 6 ohms mim.
- SURROUND SPEAKERS** : 6 ohms mim./speaker

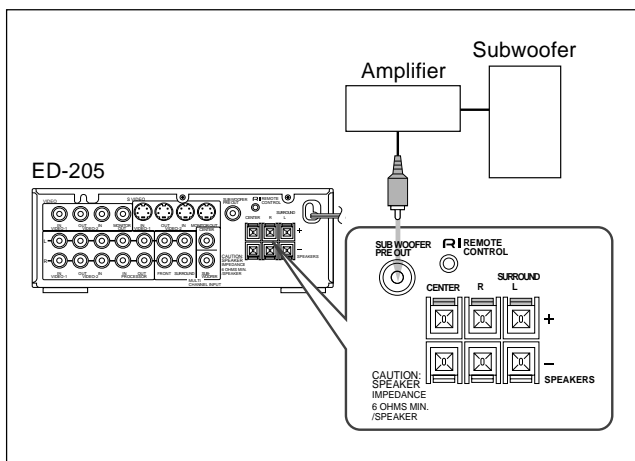
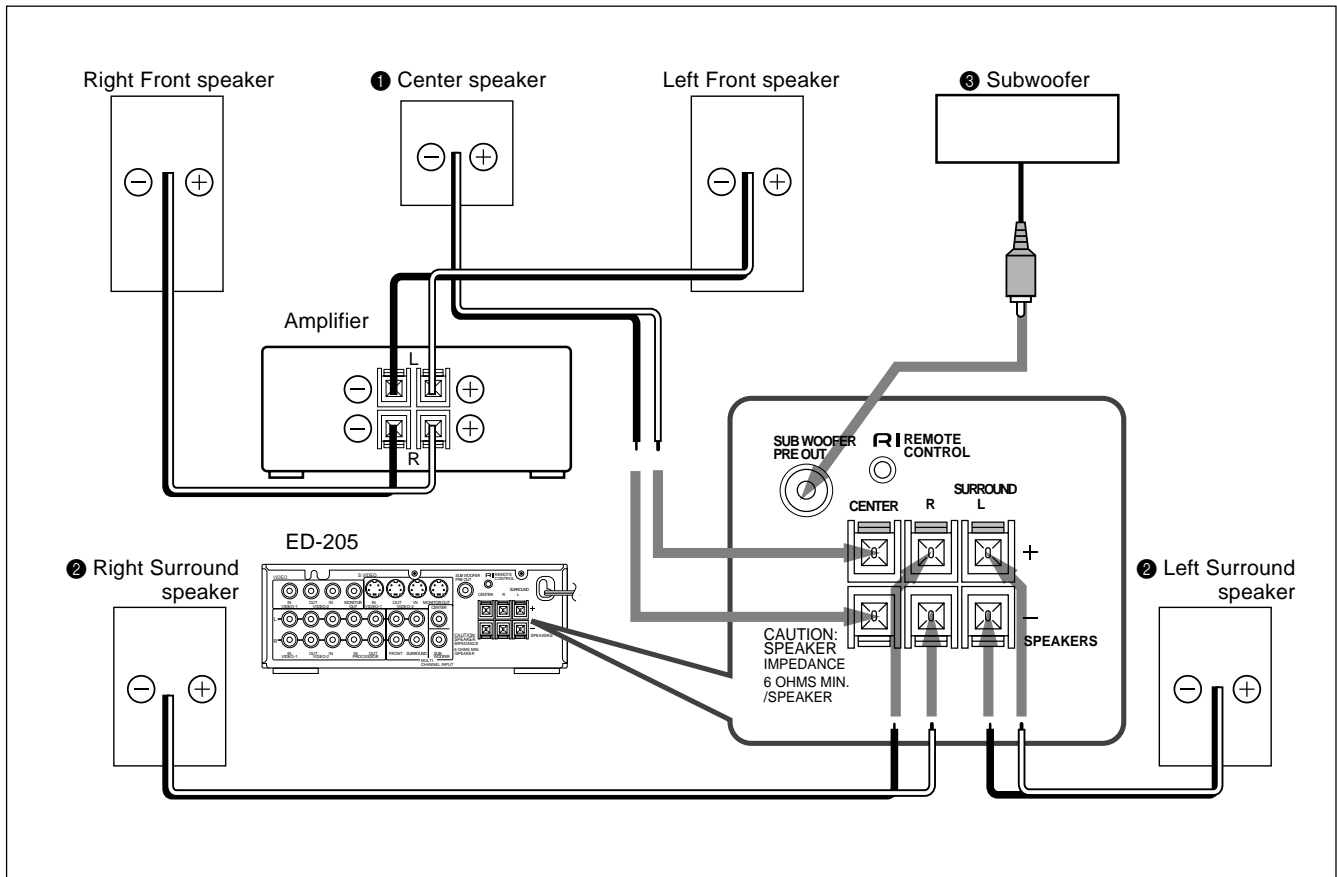

- 1 Connecting the Center speaker**
- 2 Connecting the Surround speakers**
- 3 Connecting the Subwoofer**

Connect your subwoofer to the ED-205's SUBWOOFER PRE OUT jack via an audio connection cable.

- From the SUBWOOFER PRE OUT jack, a monaural signal that is a mixture of the Left and Right channel signals is output.
- Use the ED-205's SUB WOOFER PRE OUT jack to connect your Subwoofer, even if your amplifier also provides a subwoofer connection jack.
- If your subwoofer does not have a built-in amplifier, connect an amplifier to the SUBWOOFER PRE OUT jack and the subwoofer to that amplifier.

Connecting the RI cables

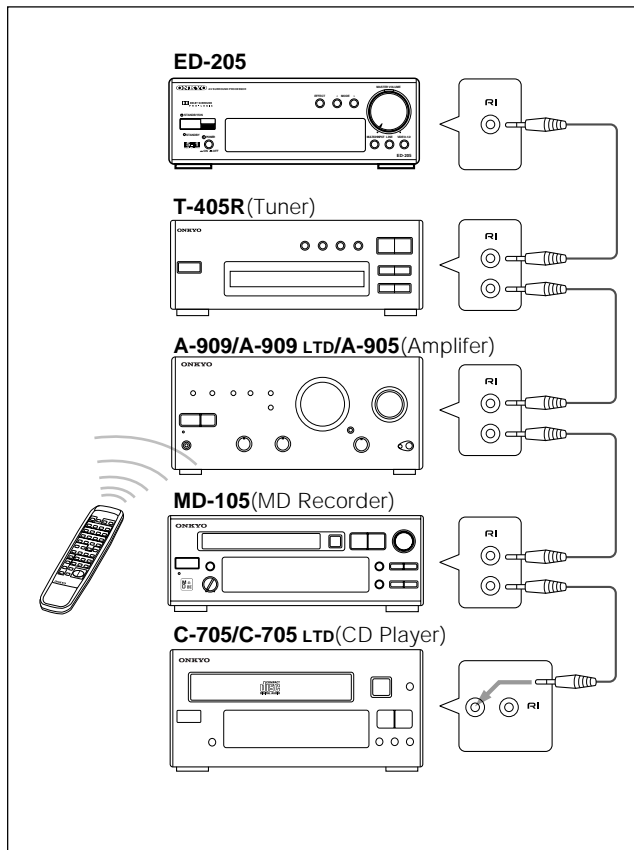

If your system is totally configured with ONKYO separate collection series components, you can use the system functions using the ED-205's supplied remote controller.

Connect all components in series using the **RI** cables, starting with the amplifier. For components having two **RI** REMOTE CONTROL jacks, you may use either of them because their functions are same.

- If your system already has been set up with the ONKYO separate collection series components, connect the ED-205's **RI** REMOTE CONTROL jack to the CD player's or tuner's unused **RI** REMOTE CONTROL jack.
- To operate the system components, point the remote controller toward the amplifier's remote control sensor.
- To operate the ED-205, point the remote controller toward the ED-205's remote control sensor.

Notes:

- Do not use the **RI** REMOTE CONTROL jack to connect products not bearing the **RI** symbol. Doing so may result in the damage to the equipment.
- Connecting only the **RI** cables is not sufficient for operation of your system. Connect the components also via audio connection cables.
- Connect the speaker cables before you connect the **RI** cables.

Connecting the power

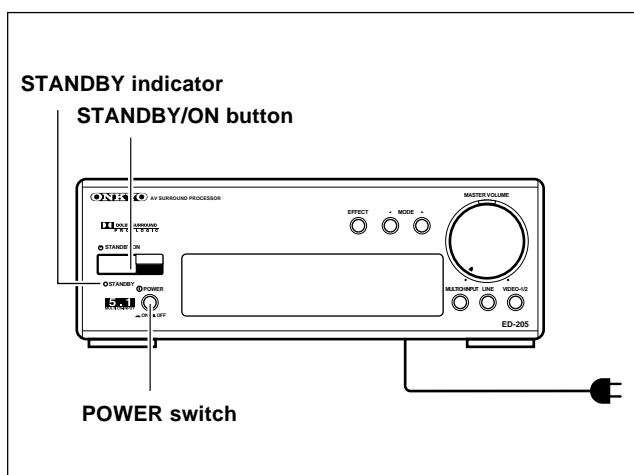

Before plugging in the unit, confirm that all connections have been made properly.

Turning on this unit's power may cause a momentary power surge, which might interfere with other electrical equipment, such as computers. If so, use a wall outlet on a different circuit.

After plugging the ED-205's power cord into an AC outlet, press the POWER switch to put the unit in power-standby status (the STANDBY indicator is lit). The remote controller cannot be used to operate the ED-205 if the POWER switch is not set ON.

When the POWER switch is set ON, pressing the STANDBY/ON button or the POWER button on the remote controller switches the ED-205 between standby status (the STANDBY indicator is lit) and power on status (the display is lit).

Press the POWER switch on the ED-205 to set it to the OFF position, turning off the unit.

Using the remote controller

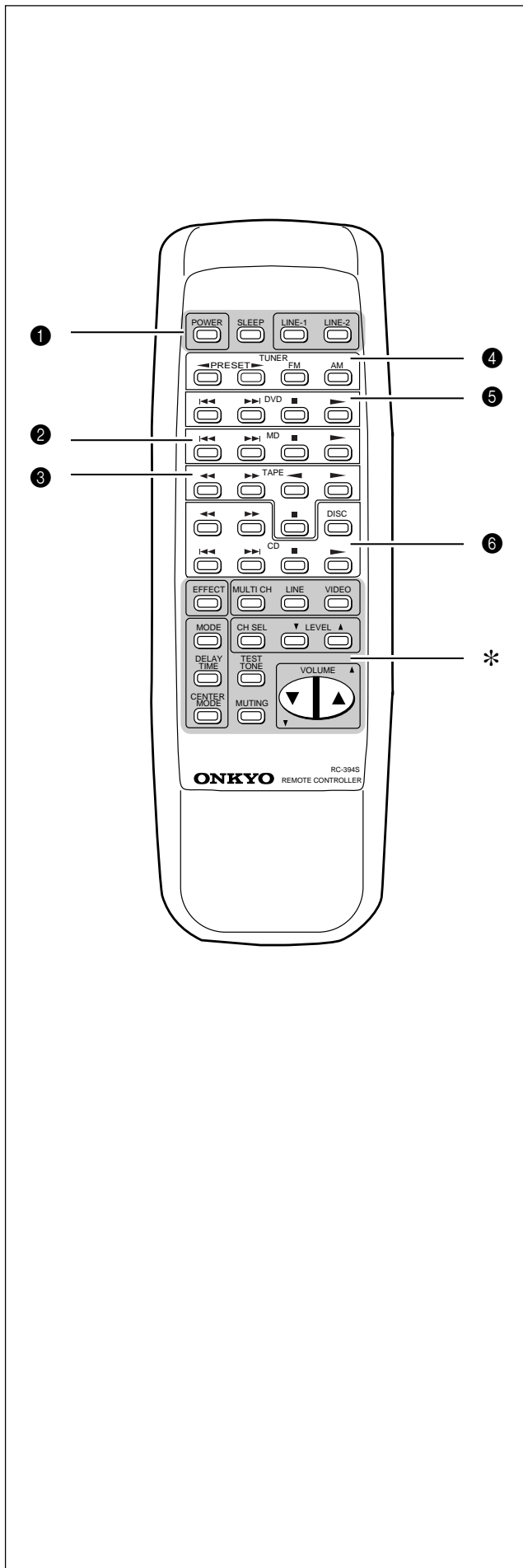

Buttons that become operative once the RI remote control cables are connected (See page 10 for how to connect the RI cables.)

① Amplifier operation buttons

Point the remote controller toward the **amplifier's** remote control sensor.

- POWER** : Turns the power on or off.
- SLEEP** : Sets the time (in units of 10 minutes) until the power is automatically shut off. Setting range: 90 to 10 minutes
- LINE-1** : Selects the component connected to the amplifier's LINE-1 jack.
- LINE-2** : Selects the component connected to the amplifier's LINE-2 jack.

② MD recorder operation buttons

Point the remote controller toward the **MD recorder's** remote control sensor.

- ⏮** : Jumps to the beginning of the current track (when playing) or previous track (when stopped).
- ⏪** : Jumps to the beginning of the next track.
- : Stops playing the MD.
- ▶** : Plays the MD.

③ Tapedeck operation buttons

Point the remote controller toward the **amplifier's** remote control sensor.

- ⏮** : Fast-rewinds the tape.
- ⏪** : Fast-forwards the tape.
- ⏩** : Plays the reverse side of the tape.
- ▶** : Plays the tape.
- : Stops playing, recording, or fast-forwarding.

④ Tuner operation buttons

Point the remote controller toward the **amplifier's** remote control sensor.

- ◀PRESET▶** : Selects preset radio stations.
- FM** : Selects FM broadcasts.
- AM** : Selects AM broadcasts.

⑤ DVD player operation buttons

Point the remote controller toward the **DVD player's** remote control sensor.

- ⏮** : Jumps to the beginning of the current chapter or track (when playing) or previous chapter or track (when stopped).
- ⏪** : Jumps to the beginning of the next chapter or track.
- : Stops playing the DVD.
- ▶** : Plays the DVD.

⑥ CD player operation buttons

Point the remote controller toward the **amplifier's** remote control sensor.

- ⏮▶▶▶** : Fast-returns or fast-forwards the CD.
- DISC** : Selects the disc to play (when using a CD changer).
- ⏮▶▶▶** : Jumps to the beginning of the current track (when playing), the previous track (when stopped), or the next track.
- : Stops playing the CD.
- ▶** : Plays the CD.

* The operation buttons for the ED-205 are explained on page 12 and later. (Point the remote controller toward the **ED-205's** remote control sensor.)

Using the Surround Modes

Using the Surround Modes

This unit provides a variety of surround effects, enabling you to enjoy the feeling of a movie theater, concert hall, or studio in your room.

To get optimized surround sounds, your speaker system plays an important role. For how to connect and setup speakers, see pages 8 and 9.

• DOLBY PRO LOGIC Surround

Use this mode to playback sources bearing  logo, such as VHS Hi-Fi, laser discs, and DVD video software. Dolby Pro Logic Surround provides four channels of surround sound (Left/Right front, Center, and monaural Surround channels), with emphasis placed on the Center speaker.

• HALL Surround

This mode is especially suitable for media already having a substantial amount of reverberation such as classical music. The atmosphere of a concert hall can be simulated.

• LIVE Surround

This mode reproduces the feel of a live performance.

• ARENA Surround

This mode recreates the feel of listening to a pop concert in a domed stadium.

For speaker systems with only Left front, Right front, and Center speakers

• DOLBY 3 STEREO

In this mode, you can hear the sound recorded for surround channels from the Left and Right speakers.

• STEREO

You can turn off the Surround function by selecting this mode to enjoy ordinary stereo sound.

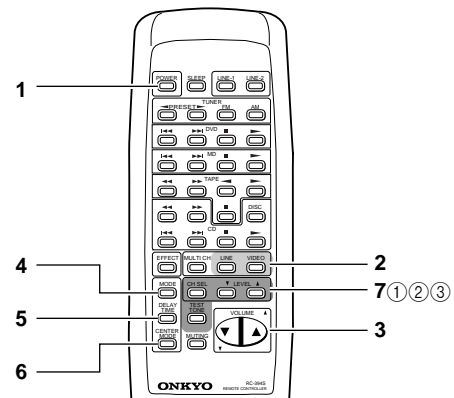
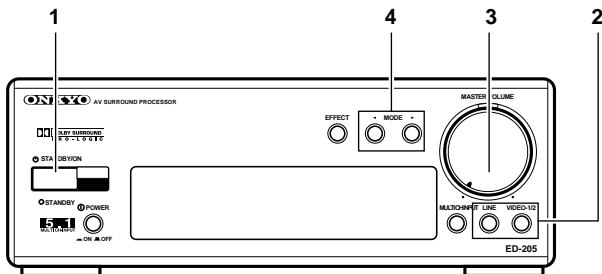

1

(Front panel)



(Remote controller)



2

LINE VIDEO-1/2

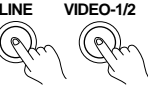

LINE VIDEO

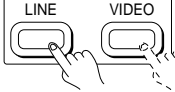

3

MASTER VOLUME

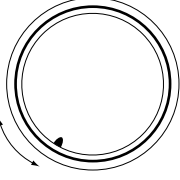

VOLUME



4

MODE

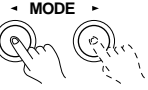

MODE



The mode changes as shown below each time the MODE ◀ or ▶ button is pressed
(Only the ▶ button is available with the remote controller.)

◀	DOLBY PRO LOGIC	→	DOLBY 3 STEREO	←
◀	ARENA	→	LIVE	←
◀		→	HALL	←

Before enjoying Surround Play

Before you can enjoy Surround Play with the ED-205, the following settings are necessary according to the configuration and placement of your speakers. Once set, the settings can be used until you alter the configuration or placement of the speakers.

Set the amplifier's volume control to a comfortable level at your normal listening position.

1. Press the POWER button.

The STANDBY indicator goes out and the display lights up.

2. Select the input source.

LINE: Press this button to play the source selected on the amplifier that is connected to the unit's PROCESSOR jacks.

VIDEO 1/2: Press this button to play the video source connected to the unit's VIDEO-1 or VIDEO-2 jacks.

3. Play Dolby Surround encoded software and adjust the sound volume.

The sound volume for all speakers simultaneously changes.

4. Press the MODE button to select

“DOLBY PRO LOGIC” or “DOLBY 3 STEREO”.

DOLBY PRO LOGIC: Select this mode if your system includes all of the Left/Right front, Center, and Surround speakers.

DOLBY 3 STEREO: Select this mode if your system lacks the Surround speakers.

Note:

- You cannot select “DOLBY 3 STEREO” when the CENTER mode setting is “PHANTOM”.

- When you have selected “DOLBY 3 STEREO” in this step, the steps 5 and 6 are unnecessary. Proceed to step 7.

Using the Surround modes

5

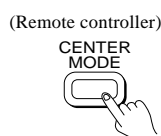

6



7 ①



②

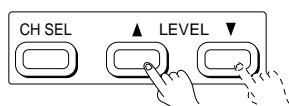

③

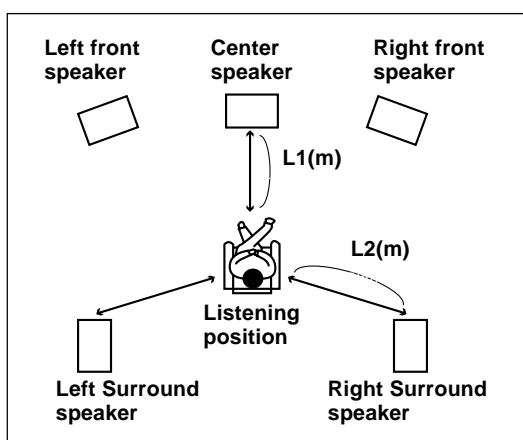

L1 - L2	Recommended delay time
Below 1 m	15 ms
1 to 2.5 m	20 ms
2.5 to 4 m	25 ms
Over 4 m	30 ms

Note: 1 ms = 1/1000 second (one millisecond)

5. Press the **CENTER MODE** button on the remote controller to select “NORMAL” or “PHANTOM”.

NORMAL: Select this mode if your system includes the Center speaker.

PHANTOM: Select this mode if your system lacks the Center speaker. In this mode, you can hear the sound originally allocated to the Center channel from the Left and Right front speakers. Without the Center speaker, place the front speakers as close to the monitor TV as possible, making sure that the screen color on the monitor TV is not affected.

6. Set the proper delay time for your listening position and speaker placement (using the remote controller).

The possible delay time settings are 15, 20, 25 or 30 ms. (For details, see “Setting the delay time” below.)

7. Adjust the output level of center speaker and surround speaker channel so that you hear the same sound volume from each speaker at the listening position (using the remote controller).

You cannot change the output levels of the Left and Right front speakers. While listening to the test tone, adjust the output levels of other speakers.

This adjustment is normally made from the listening position using the remote controller.

① Press the **TEST TONE** button.

The test tone starts sounding at the Left front speakers. After 2 seconds, the test tone sounds at the next speaker.

• When the Center Mode setting is “NORMAL”

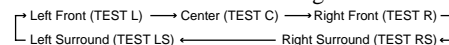

• When the Center Mode setting is “PHANTOM”

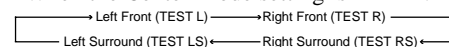

• When the Surround Mode setting is “DOLBY 3 STEREO”

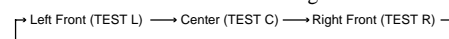

② Adjust the output level using the **LEVEL ▲/▼** buttons.

The adjustment range is -12dB to +12dB.

The test tone stays at the same speaker while the adjustment is in progress.

You can select the speaker channel to adjust by using the **CH SEL** button on the remote controller.

③ Press the **TEST TONE** button again.

The test tone stops sounding.

Setting the delay time

“Delay time” is set according to the distance from the Center and Surround Speakers to the listening position.

• In the **DOLBY PRO LOGIC** mode

Set the proper delay time for your listening position and speaker placement.

Measure the distance from your listening position to the Center speaker (L1) and to the Surround speakers (L2). Then, choose the correct delay time in the table below according to the difference between L1 and L2.

Ex.

Assume, in the figure on the left, that the distance from the Center speaker to your listening position (L1) is 2 meters and the distance from the Surround speakers to your listening position (L2) is 3.5 meters. Since the difference between L1 and L2 is 1.5 meters, the table indicates that the correct delay time is 20 ms.

• In the **HALL, LIVE, or ARENA** mode

Set the delay time according to your taste while listening to the sound. The possible delay time settings are 15, 20, 25, 30, 40, 50 or 60 ms.

Playing a source

If you wish to adjust the sound volume of the Right or Left front speaker, always use the ED-205's MASTER VOLUME knob with the amplifier's volume control at the Surround setting position as explained on pages 12 and 13. The output levels of the Center and Surround speakers must be readjusted every time you alter the amplifier's volume control setting.

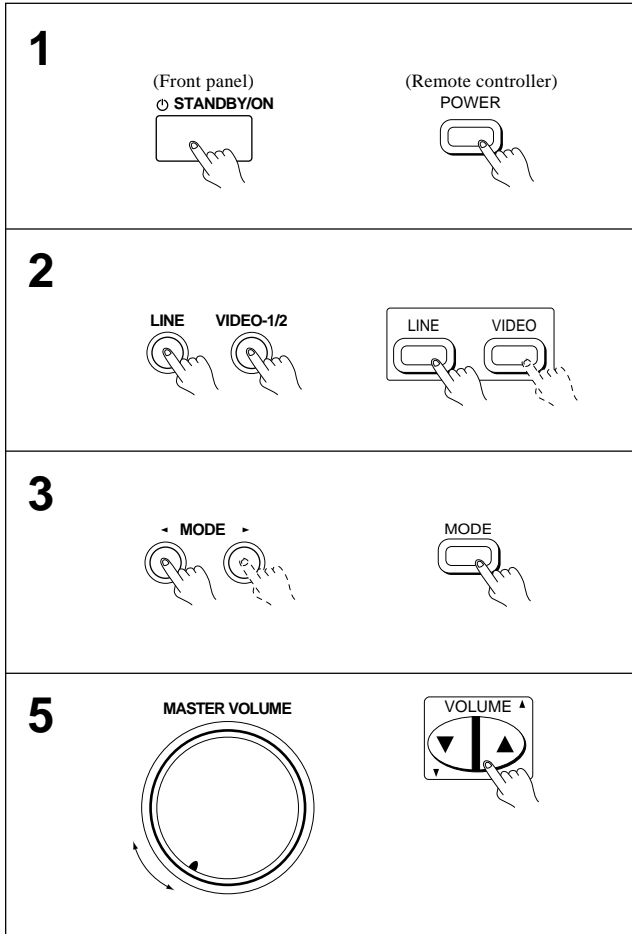
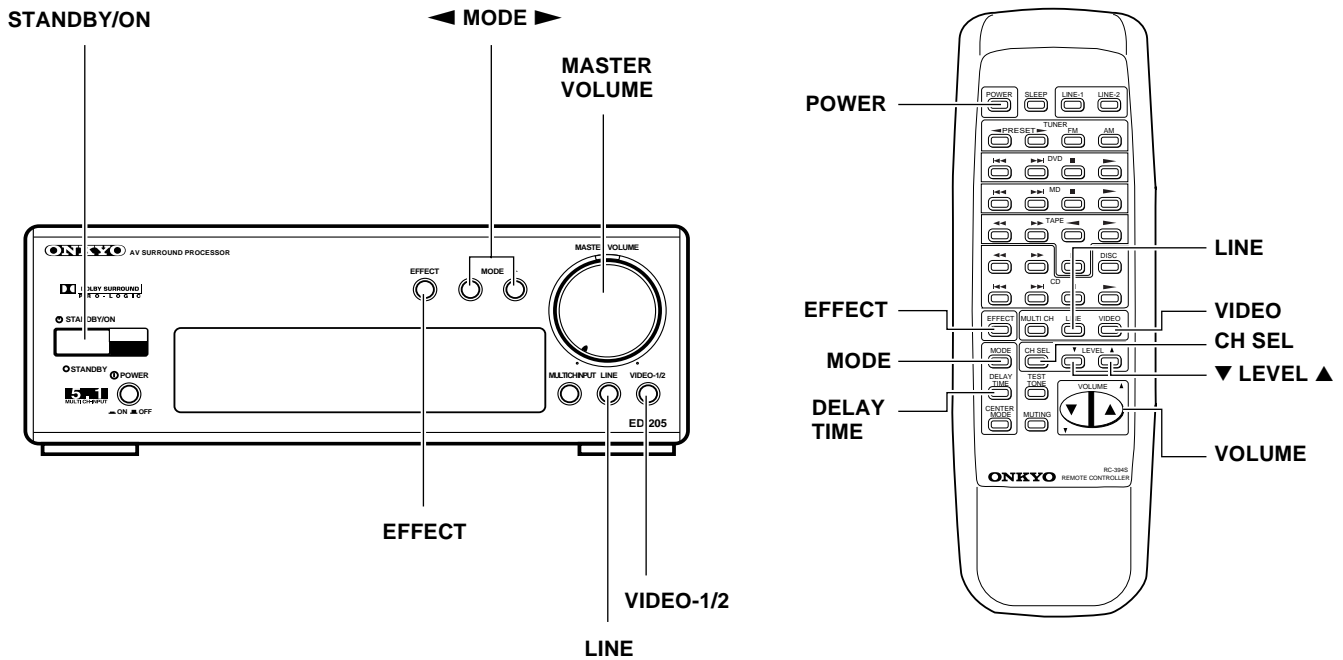

Playing a Dolby Pro Logic surround source

Before playing a Dolby Pro Logic surround source, the unit must be set according to "Before enjoying Surround Play" on pages 12 and 13.

1. Press the POWER button.

The STANDBY indicator goes out and the display lights up.

2. Select the input source.

LINE: Press this button to play the source selected on the amplifier that is connected to the unit's PROCESSOR jacks.

VIDEO 1/2: Press this button to play the video source connected to the unit's VIDEO-1 or VIDEO-2 jacks.

3. Press the MODE button to select "DOLBY PRO LOGIC" or "DOLBY 3 STEREO".

The mode changes as shown each time the MODE ◀ or ▶ button is pressed (Only the ▶ button is available with the remote controller.)

4. Play a Dolby Pro Logic encoded source.

5. Adjust the sound volume.

The sound volume for all speakers simultaneously changes.

Adjust the sound volume from the listening position using the remote controller.

* The sound volume for the Subwoofer can be adjusted by first pressing the CH SEL button to select "SW" on the display and then using the LEVEL ▲/▼ button.

If you wish to fine-adjust the sound volume for a channel while listening to the sound, select that speaker on the display in the same way and then adjust the sound volume.

Playing a source

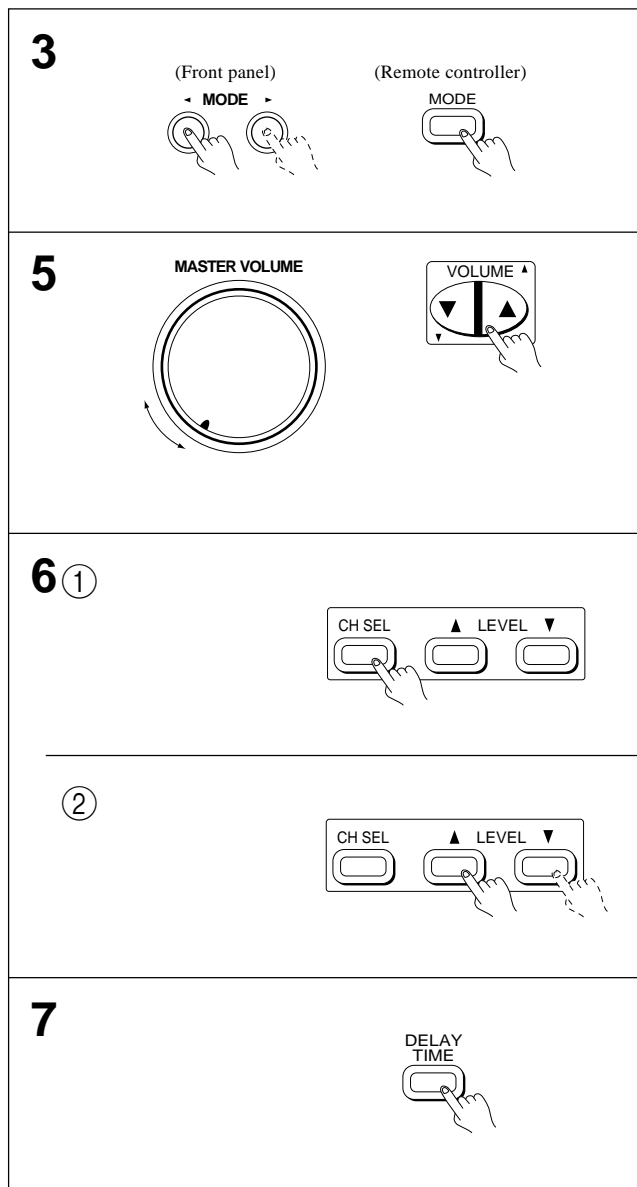

Playing in the HALL, LIVE, or ARENA surround mode

Before you enjoy HALL, LIVE, or ARENA surround mode, it is recommended that the unit be set according to “Before enjoying the Surround Play” on pages 12 and 13.

1. Same as step 1. of “Playing a Dolby Pro Logic surround source”.
2. Same as step 2. of “Playing a Dolby Pro Logic surround source”.
3. Press the MODE button to select “HALL” “LIVE”, or “ARENA”.

The mode changes as shown below each time the MODE ◀ or ▶ button is pressed

(Only the ▶ button is available with the remote controller.)

4. Play a Dolby Pro Logic surround source.

5. Adjust the sound volume.

The sound volume for all speakers simultaneously changes.

Adjust the sound volume from the listening position using the remote controller.

6. Adjust the output level of each speaker according to your taste.

If you have selected “HALL” or “ARENA” in step 3, you can adjust the output levels for the Right Surround speaker (R-SUR), Left Surround speaker (L-SUR), and Subwoofer (SW).

If you have selected “LIVE” in step 3, you can adjust the output levels for the Center speaker (CENTER), Right Surround speaker (R-SUR), Left Surround speaker (L-SUR), and Subwoofer (SW).

- ① Select the speaker channel to adjust by using the CH SEL button on the remote controller.
- ② Adjust the output level using the LEVEL ▲/▼ buttons.

The adjustment range is -12dB to +12dB.

Note:

The output levels you set in this step will be lost if the ED-205 is turned off.

7. Set the proper delay time for your listening position and speaker placement.

The possible delay time settings are 15, 20, 25, 30, 40, 50 or 60 ms. (For details, see “Setting the delay time” on page 13.)

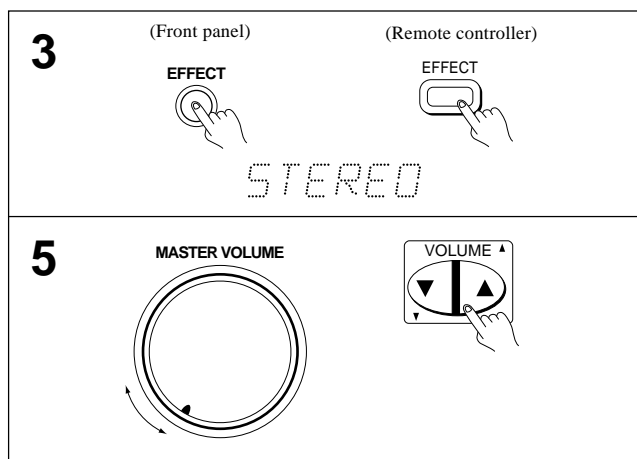

Playing in the Stereo mode

1. Same as step 1. of “Playing a Dolby Pro Logic surround source”.
2. Same as step 2. of “Playing a Dolby Pro Logic surround source”.
3. Press the EFFECT button to select “STEREO”.

4. Play a source.

5. Adjust the sound volume.

The sound volume for all speakers simultaneously changes.

Adjust the sound volume from the listening position using the remote controller.

Playing a source

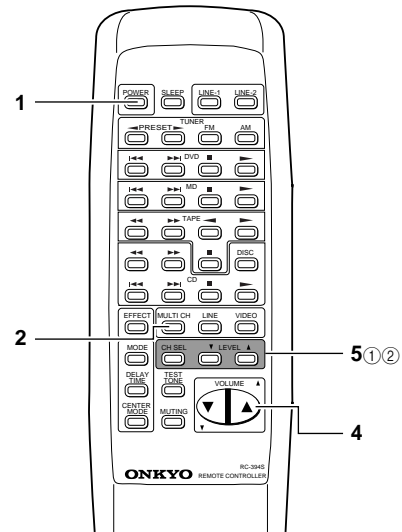
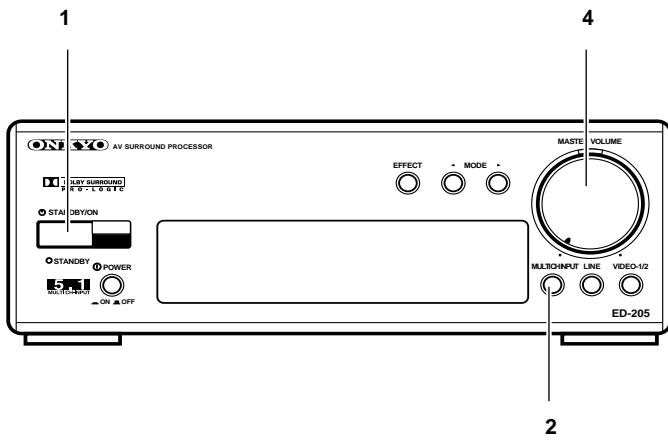

1	<p>(Front panel)</p> <p>STANDBY/ON</p>	<p>(Remote controller)</p> <p>POWER</p>
2	<p>MULTI CH INPUT</p>	<p>MULTI CH</p>
4	<p>MASTER VOLUME</p>	<p>VOLUME</p>
5①	<p>CH SEL ▲ LEVEL ▼</p>	
②	<p>CH SEL ▲ LEVEL ▼</p>	

Playing a multi-channel input source

The following describes how to play a multi-channel input source. A multi channel input source refers to equipment with 5.1-channel output jacks (such as a DVD player). When connected to the ED-205, the equipment outputs separate signals to the 5 speaker channels (Left/Right front, Center, and Left/Right Surround). The ED-205 then outputs the signal for the subwoofer channel to its SUBWOOFER PRE OUT jack. In the Multi-channel input mode, you cannot use the surround modes. For how to connect a multi-channel input source, see page 7.

Before playing a multi-channel input source

- The ED-205 stores the output level you set for each speaker connected to the MULTI CHANNEL INPUT jack. This stored setting has no effect on the DOLBY PRO LOGIC output levels you set using- the test tone.

1. Press the POWER button.

The STANDBY indicator goes out and the display lights up.

2. Press the MULTI-CH INPUT button.

3. Play the input source connected to the MULTI CHANNEL INPUT jacks.

4. Adjust the sound volume.

The sound volume for all speakers simultaneously changes.

Adjust the sound volume from the listening position using the remote controller.

5. Adjust the output level of each speaker according to your taste.

The output levels for the Center speaker (CENTER), Right Surround speaker (R-SUR), Left Surround speaker (L-SUR), and Subwoofer (SW) can be adjusted.

- ① Select the speaker channel to adjust by using the CH SEL button on the remote controller.
- ② Adjust the output level using the LEVEL ▲/▼ buttons.

The adjustment range for the Center, and Left/Right Surround speakers is -12dB to +12dB. For the Subwoofer, it is -30 to +12dB.

Troubleshooting

If you have any problems with the unit, please check the troubleshooting table below.

This unit contains a sensitive microcomputer, which under certain circumstances might fail to operate due to excessive noise interference. In such an event, disconnect the main plug from the electrical outlet and reconnect it after 5 seconds. Please also ensure that all system connections are correct and secure.

If the problem persists, or if the symptom is not found in the troubleshooting table, disconnect the power cord, and notify your Onkyo service station. Include your name, address, and telephone number, as well as the product name, model number (ED-205), serial number, and a detailed description of the problem.

	Symptom	Cause	Remedy
Power	The unit does not turn on.	<ul style="list-style-type: none"> The power plug is not inserted completely. 	<ul style="list-style-type: none"> Insert the unit's power plug completely into a power outlet. [See page 10.]
	No image or sound.	<ul style="list-style-type: none"> The cables are not connected securely. 	<ul style="list-style-type: none"> Check again the connection and connect the plugs and cables securely. [See pages 6 and 7.]
		<ul style="list-style-type: none"> The cables are not connected correctly. The input source equipment has not been selected. 	<ul style="list-style-type: none"> Check that the video and audio cables are connected correctly. [See pages 6 and 7.] Check the input source connection and select the correct input source by pressing the correct input selector button (LINE, VIDEO-1/2, MULTI-CH INPUT). [See pages 14 to 16.]
Speaker	No sound from front speakers.	<ul style="list-style-type: none"> The MASTER VOLUME knob on the amplifier is set to the minimum. 	<ul style="list-style-type: none"> Set the sound volume properly. [See pages 14 to 16.]
		<ul style="list-style-type: none"> The Muting mode is set on the amplifier. 	<ul style="list-style-type: none"> Press the MUTING button on the amplifier to cancel the Muting mode.
		<ul style="list-style-type: none"> The audio connection cables and speaker cables are not connected properly. 	<ul style="list-style-type: none"> Check the connection again and connect the plugs and cables properly. [See page 6.]
	No sound or quiet sound from Center speaker.	<ul style="list-style-type: none"> The STEREO mode is set. 	<ul style="list-style-type: none"> Press the EFFECT button to select a correct Surround mode.
		<ul style="list-style-type: none"> The output level is not adjusted correctly. 	<ul style="list-style-type: none"> Adjust the output level of the Center speaker to the correct level. [See pages 12 to 16.]
		<ul style="list-style-type: none"> The Center mode is set to "PHANTOM" when the Surround mode is "DOLBY PRO LOGIC". 	<ul style="list-style-type: none"> Set the Center mode to "NORMAL". [See page 13.]
No sound or quiet sound from Surround speakers.	<ul style="list-style-type: none"> The Surround mode is set to "HALL" or "ARENA". 	<ul style="list-style-type: none"> Set the Surround mode to "DOLBY PRO LOGIC", "DOLBY 3 STEREO", or "LIVE". [See pages 12 to 15.] 	
	<ul style="list-style-type: none"> The STEREO mode is set. 	<ul style="list-style-type: none"> Press the EFFECT button to select the correct Surround mode. 	
	<ul style="list-style-type: none"> The output levels of the Surround speakers are not adjusted correctly. 	<ul style="list-style-type: none"> Adjust the output levels of the Surround speakers to correct levels. [See pages 12 to 16.] 	
Others	No image on the TV connected to the S VIDEO MONITOR OUT jack.	<ul style="list-style-type: none"> The Surround mode is set to "DOLBY 3 STEREO". 	<ul style="list-style-type: none"> Press the MODE button to select "DOLBY PRO LOGIC", "HALL", "LIVE", or "ARENA". [See pages 12 to 15.]
		<ul style="list-style-type: none"> The video source is connected to the VIDEO IN jacks. 	<ul style="list-style-type: none"> The signals input to the VIDEO IN jacks are not output from the S VIDEO MONITOR OUT jack. Connect the video source to the S VIDEO IN jack or connect the TV to the VIDEO MONITOR OUT jack. [See page 6.]
	No test tone sound.	<ul style="list-style-type: none"> The S-Video cables are not connected completely. 	<ul style="list-style-type: none"> Connect the S-Video cables completely. [See page 6.]
Remote controller	No image in Multi-channel input mode.	<ul style="list-style-type: none"> The Multi-channel input mode is set. 	<ul style="list-style-type: none"> The test tone does not sound when the Multi-channel input mode is set. [See pages 12 and 13.]
		<ul style="list-style-type: none"> The multi-channel input source is not connected correctly. 	<ul style="list-style-type: none"> Check the connection for the multi-channel input source. [See page 7.]
	Buttons on the front panel are operational, but those on remote controller are not.	<ul style="list-style-type: none"> The batteries are not installed correctly. The batteries are run down. 	<ul style="list-style-type: none"> Insert the batteries correctly. [See page 5.] Replace the batteries with new ones. [See page 5.]

Control positions and names

In this section, the name of each switch or button that appears in the description of this manual is indicated. The function or description of the switch or button name is also included when necessary. The numbers shown in each pair of brackets [] indicate the page numbers of the manual in which the switch or button is explained.

Front panel

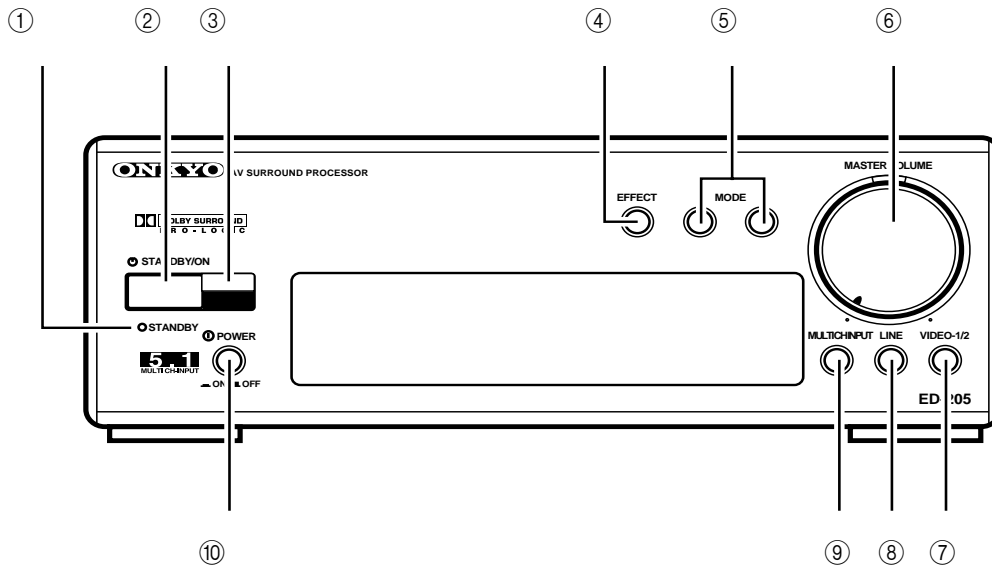

Display

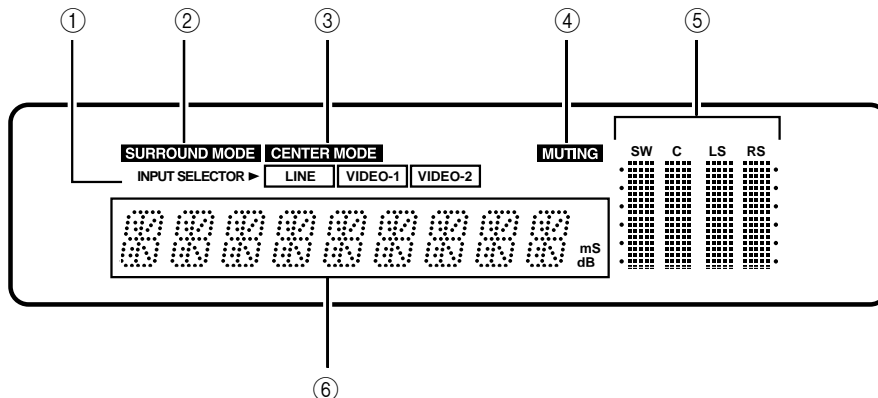

Front panel

- ① **STANDBY indicator** [10]
- ② **STANDBY/ON button** [10,12,14,16]
Power ON/Standby button
- ③ **Remote control sensor** [5]
- ④ **EFFECT button** [15]
Changes between Surround and Stereo modes.
- ⑤ **MODE button** [12,14,15]
Changes between all Surround modes.
- ⑥ **MASTER VOLUME knob** [12,14,15,16]
- ⑦ **VIDEO-1/2 button** [12,14]
Video input selector button
- ⑧ **LINE button** [12,14]
Line input selector button
- ⑨ **MULTI CH INPUT button** [16]
Multi-channel input selector button
- ⑩ **POWER switch** [10]

Display

- ① **INPUT SELECTOR indicator**
- ② **SURROUND MODE indicator**
- ③ **CENTER MODE indicator**
- ④ **MUTING indicator**
- ⑤ **Speaker output level indicator**
- ⑥ **Multi-function display**

Control positions and names

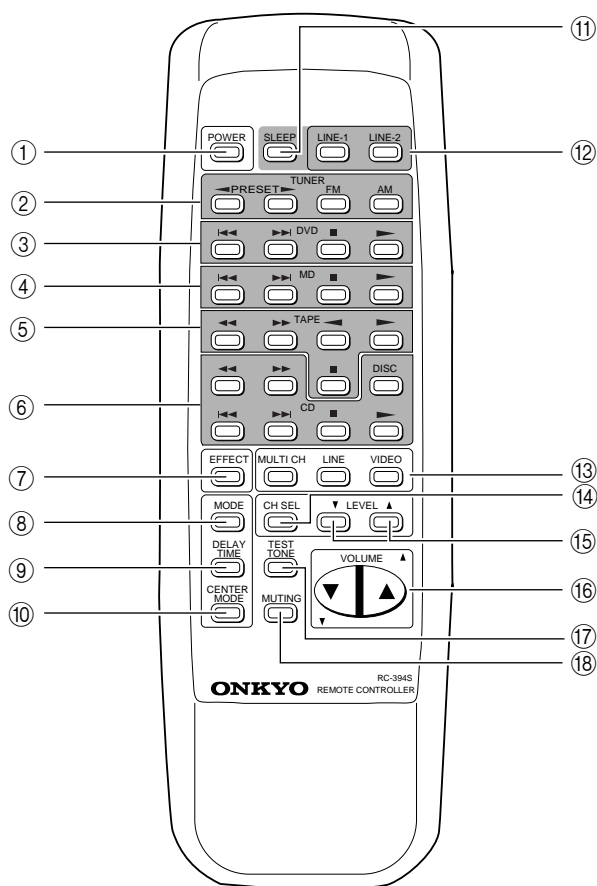

Remote controller

When the unit is connected to Onkyo separate collection series components (amplifier, tuner, DVD player, MD recorder, cassette deck, and CD player), you can use the supplied remote controller to operate each component (see page 11). The buttons shown in shaded areas are those for operating components other than the ED-205.

- ① **POWER button [11,12,14,16]**
Turns on/off the amplifier or ED-205.
- ② **TUNER operation buttons [11]**
- ③ **DVD operation buttons [11]**
- ④ **MD operation buttons [11]**
- ⑤ **TAPE operation buttons [11]**
- ⑥ **CD operation buttons [11]**
- ⑦ **EFFECT button [15]**
Changes between Surround and Stereo modes.
- ⑧ **MODE button [12,14,15]**
Changes between all Surround modes.
- ⑨ **DELAY TIME button [13]**
- ⑩ **CENTER MODE button [13]**
- ⑪ **SLEEP button [11]**
- ⑫ **LINE-1 /LINE-2 buttons [11]**
- ⑬ **MULTI CH /LINE / VIDEO buttons [12,14,16]**
Selects input source
- ⑭ **CH SEL button [13,15,16]**
Selects individual speakers (channels).
- ⑮ **LEVEL ▲/▼ button [13,15,16]**
- ⑯ **VOLUME ▲/▼ button [12,14,15,16]**
- ⑰ **TEST TONE button [13]**
- ⑱ **MUTING button***

* MUTING button

Pressing this button temporarily reduces sound volume. Pressing the button again restores the previous sound volume.

Specifications

Amplifier (Audio) section

Power output	
Center	: 22 W at 6 Ω 1kHz (DIN)
Surround	: 22+22 W at 6 Ω 1kHz (DIN)
Center	: 29 W at 6 Ω 1kHz (EIAJ)
Surround	: 29+29 W at 6 Ω 1kHz (EIAJ)
Damping factor	: 40 at 8 Ω
Input sensitivity /Impedance	
VIDEO-1/2, PROCESSOR IN	: 300 mV, 50 k Ω
MULTI CHANNEL INPUT	: 300 mV, 50 k Ω
Output level /Impedance	
VIDEO-2	: 300 mV, 2.2 k Ω
PROCESSOR OUT	: 300 mV, 1 k Ω
Muting	: -40 dB
Frequency response	
CENTER	: 20 to 20,000 Hz +/-1 dB
SURROUND	: 100 to 7,000 Hz +/-1 dB
Total Harmonic Distortion	
CENTER	: 0.8 %
SURROUND	: 0.8 %
Signal-to-noise ratio	
CENTER	: 80 dB
SURROUND	: 75 dB

Video section

Input sensitivity /Impedance	
VIDEO-1/2	: 1 Vp-p/75 Ω (S-VIDEO C 0.28 Vp-p/75 Ω)
Output level /Impedance	
VIDEO-2, MONITOR OUT	: 1 Vp-p/75 Ω (S-VIDEO C 0.28 Vp-p/75 Ω)

General

Power consumption	: 65 W
Power supply	: AC 230 V, 50 Hz : AC 120 V, 60 Hz
Dimensions (W x H x D)	: 205 x 76 x 350 mm
Weight	: 3.7 kg

Remote control unit RC-394S

Control method	: Infrared rays
Control range	: Approx. 5 meters
Batteries	: Size AA dry cell (1.5 V) x 2

* Specifications and features are subject to change without notice.

ONKYO CORPORATION

Sales & Product Planning Div.: 2-1, Nisshin-cho, Neyagawa-shi, OSAKA 572-8540, JAPAN
Tel: 072-831-8111 Fax: 072-833-5222 <http://www.onkyo-intl.com>

ONKYO U.S.A. CORPORATION

18 Park Way, Upper Saddle River, N.J. 07458, U.S.A.
Tel: 201-785-2600 Fax: 201-825-8150/785-2650 <http://www.onkyousa.com>

ONKYO EUROPE ELECTRONICS GmbH

Liegnitzerstrasse 6, 82194 Groebenzell, GERMANY
Tel: +49-8142-4401-0 Fax: +49-8142-4401-555 <http://www.onkyo.net>

ONKYO CHINA LIMITED

Units 2102-2107 Metroplaza Tower I, 223 Hing Fong Road Kwai Chung,
N.T., HONG KONG Tel: 852-2429-3118 Fax: 852-2428-9039 <http://www.onkyochina.com>

