

ONKYO®

Audio CD Recorder

DX-R700

Instruction Manual



Thank you for purchasing the Onkyo Audio CD Recorder. Please read this manual thoroughly before making connections and plugging in the unit. Following the instructions in this manual will enable you to obtain optimum performance and listening enjoyment from your new Audio CD Recorder. Please retain this manual for future reference.

Contents

Before using 2

Connections 14

Operations 16

Other Information 42

Before using

Thank you for purchasing ...

Thank you for purchasing the Onkyo DX-R700 CD Recorder.

Please read this manual thoroughly before making connections and plugging in the unit.

Following the instructions in this manual will enable you to obtain the optimum performance and listening enjoyment from your new DX-R700.

Please retain this manual for future reference.

Main Features

- **CD/CD-R/CD-RW Disc Compatibility**
- **Auto Finalizing Function**
- **32kHz/44.1kHz/48kHz Sampling-Rate Converter**
- **1 Optical/1 Coaxial Digital Inputs**
- **Signal Synchro Recording**
- **Name input function allowing you to specify a disc name, track titles, and an artist name.**
- **Adjustable Recording Volume (Digital/Analog)**
- **High-Resolution D/A & A/D Converter**
- **1 Optical/1 Coaxial Digital Outputs**
- **RI Cable Included**

WARNING:

TO REDUCE THE RISK OF FIRE OR ELECTRIC SHOCK, DO NOT EXPOSE THIS APPLIANCE TO RAIN OR MOISTURE.

CAUTION:

TO REDUCE THE RISK OF ELECTRIC SHOCK, DO NOT REMOVE COVER (OR BACK). NO USER-SERVICEABLE PARTS INSIDE. REFER SERVICING TO QUALIFIED SERVICE PERSONNEL.



The lightning flash with arrowhead symbol, within an equilateral triangle, is intended to alert the user to the presence of uninsulated "dangerous voltage" within the product's enclosure that may be of sufficient magnitude to constitute a risk of electric shock to persons.

The exclamation point within an equilateral triangle is intended to alert the user to the presence of important operating and maintenance (servicing) instructions in the literature accompanying the appliance.



Important Safeguards

1. **Read Instructions** – All the safety and operating instructions should be read before the appliance is operated.
2. **Retain Instructions** – The safety and operating instructions should be retained for future reference.
3. **Heed Warnings** – All warnings on the appliance and in the operating instructions should be adhered to.
4. **Follow Instructions** – All operating and use instructions should be followed.
5. **Cleaning** – Unplug the appliance from the wall outlet before cleaning. The appliance should be cleaned only as recommended by the manufacturer.
6. **Attachments** – Do not use attachments not recommended by the appliance manufacturer as they may cause hazards.
7. **Water and Moisture**– Do not use the appliance near water –for example, near a bath tub, wash bowl, kitchen sink, or laundry tub; in a wet basement; or near a swimming pool; and the like.
8. **Accessories** – Do not place the appliance on an unstable cart, stand, tripod, bracket, or table. The appliance may fall, causing serious injury to a child or adult, and serious damage to the appliance. Use only with a cart, stand, tripod, bracket, or table recommended by the manufacturer, or sold with the appliance. Any mounting of the appliance should follow the manufacturer's instructions, and should use a mounting accessory recommended by the manufacturer.
9. An appliance and cart combination should be moved with care. Quick stops, excessive force, and

PORTABLE CART WARNING



53125A

Important Safeguards

uneven surfaces may cause the appliance and cart combination to overturn.

10. **Ventilation** – Slots and openings in the cabinet are provided for ventilation and to ensure reliable operation of the appliance and to protect it from overheating, and these openings must not be blocked or covered. The openings should never be blocked by placing the appliance on a bed, sofa, rug, or other similar surface. The appliance should not be placed in a builtin installation such as a bookcase or rack unless proper ventilation is provided. There should be free space of at least 5 cm (2 in.) and an opening behind the appliance.
11. **Power Sources** – The appliance should be operated only from the type of power source indicated on the marking label. If you are not sure of the type of power supply to your home, consult your appliance dealer or local power company.
12. **Grounding or Polarization** – The appliance may be equipped with a polarized alternating current line plug (a plug having one blade wider than the other). This plug will fit into the power outlet only one way. This is a safety feature. If you are unable to insert the plug fully into the outlet, try reversing the plug. If the plug should still fail to fit, contact your electrician to replace your obsolete outlet. Do not defeat the safety purpose of the polarized plug.
13. **Power-Cord Protection** – Powersupply cords should be routed so that they are not likely to be walked on or pinched by items placed upon or against them, paying particular attention to cords at plugs, convenience receptacles, and the point where they exit from the appliance.
14. **Lightning** – For added protection for the appliance during a lightning storm, or when it is left unattended and unused for long periods of time, unplug it from the wall outlet and disconnect the antenna or cable system. This will prevent damage to the appliance due to lightning and power-line surges.
15. **Overloading** – Do not overload wall outlets, extension cords, or integral convenience receptacles as this can result in a risk of fire or electric shock.
16. **Object and Liquid Entry** – Never push objects of any kind into the appliance through openings as they may touch dangerous voltage points or short-out parts that could result in a fire or electric shock. Never spill liquid of any kind on the appliance.
17. **Servicing** – Do not attempt to service the appliance yourself as opening or removing covers may expose you to dangerous voltage or other hazards. Refer all servicing to qualified service personnel.
18. **Damage Requiring Service** – Unplug the appliance from the wall outlet and refer servicing to qualified service personnel under the following conditions:
 - A. When the power-supply cord or plug is damaged,
 - B. If liquid has been spilled, or objects have fallen into the appliance,
 - C. If the appliance has been exposed to rain or water,
 - D. If the appliance does not operate normally by following the operating instructions. Adjust only those controls that are covered by the operating instructions as an improper adjustment of other controls may result in damage and will often require extensive work by a qualified technician to restore the appliance to its normal operation,
 - E. If the appliance has been dropped or damaged in any way, and
 - F. When the appliance exhibits a distinct change in performance – this indicates a need for service.
19. **Replacement Parts** – When replacement parts are required, be sure the service technician has used replacement parts specified by the manufacturer or have the same characteristics as the original part. Unauthorized substitutions may result in fire, electric shock, or other hazards.
20. **Safety Check** – Upon completion of any service or repairs to the appliance, ask the service technician to perform safety checks to determine that the appliance is in proper operation condition.
21. **Wall or Ceiling Mounting** – The appliance should be mounted to a wall or ceiling only as recommended by the manufacturer.
22. **Heat** – The appliance should be situated away from heat sources such as radiators, heat registers, stoves, or other appliances (including amplifiers) that produce heat.

Precautions

1. Warranty Claim

You can find the serial number on the rear panel of this unit. In case of warranty claim, please report this number.

2. Recording Copyright

Recording of copyrighted material for other than personal use is illegal without permission of the copyright holder.

3. Power

WARNING

BEFORE PLUGGING IN THE UNIT FOR THE FIRST TIME, READ THE FOLLOWING SECTION CAREFULLY.

The voltage of the available power supply differs according to country or region. Be sure that the power supply voltage of the area where this unit will be used meets the required voltage (e.g., AC 230 V, 50 Hz or AC 120 V, 60 Hz) written on the rear panel.

Worldwide models are equipped with a voltage selector to conform with local power supplies. Be sure to set this switch to match the voltage of the power supply in your area before plugging in the unit.

Determine the proper voltage for your area: 220-230 V or 120 V.

If the preset voltage is not correct for your area, insert a screwdriver into the groove in the switch. Slide the switch all the way to the upper (120 V) or to the lower (220-230 V), whichever is appropriate.

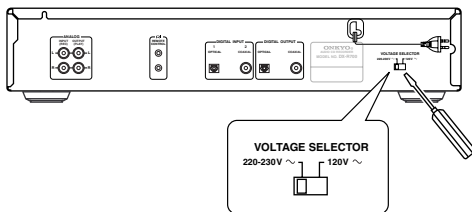

4. Do not touch this unit with wet hands

Do not handle this unit or power cord when your hands are wet or damp. If water or any other liquid enters the case, take this unit to an authorized service center for inspection.

5. Location of this unit

Place this unit in a well-ventilated location.

Take special care to provide plenty of ventilation on all sides of this unit especially when it is placed in an audio rack. If ventilation is blocked, this unit may overheat and malfunction.

Do not expose this unit to direct sunlight or heating units as this unit's internal temperature may rise and shorten the life of the pickup.

Avoid damp and dusty places and places directly affected by vibrations from the speakers. In particular, avoid placing the unit on or above one of the speakers.

Be sure this unit is placed in a horizontal position. Never place it on its side or on a slanted surface as it may malfunction.

Do not place near tuners or TV sets.

If placed next to a TV or tuner, it may cause reception interference resulting in some noise in the TV or tuner output.

6. Care

From time to time you should wipe the front and rear panels and the cabinet with a soft cloth. For heavier dirt, dampen a soft cloth in a weak solution of mild detergent and water, wring it out dry, and wipe off the dirt. Following this, dry immediately with a clean cloth.

Do not use rough material, thinners, alcohol or other chemical solvents or cloths since these could damage the finish or remove the panel lettering.

7. Points to remember

If this unit is brought from a cold environment to a warm one or is in a cold room that is quickly heated, condensation may form on the pickup, preventing proper operation. In this case, remove the disc and leave the power ON for about one hour to remove the condensation.

When transporting this unit, be careful not to bump it.

Precautions

DANGER:

INVISIBLE LASER RADIATION WHEN OPEN AND INTERLOCK FAILED OR DEFEATED. AVOID DIRECT EXPOSURE TO BEAM.

CAUTION:

THIS PRODUCT UTILIZES A LASER. USE OF CONTROLS OR ADJUSTMENTS OR PERFORMANCE OF PROCEDURES OTHER THAN THOSE SPECIFIED HEREIN MAY RESULT IN HAZARDOUS RADIATION EXPOSURE.

For U.S. model

The laser is covered by a housing which prevents exposure during operation or maintenance. However, this product is classified as a Laser Product by CDRH (Center for Devices and Radiological Health) which is a department of the Food and Drug Administration. According to their regulations 21 CFR section 1002.30, all manufacturers who sell Laser Products must maintain records of written communications between the manufacturer, dealers and customers concerning radiation safety. If you have any complaints about instructions or explanations affecting the use of this product, please feel free to write to the address on the back page of this manual. When you write us, please include the model number and serial number of your unit.

In compliance with Federal Regulations, the certification, identification and the period of manufacture are indicated on the rear panel.

FCC INFORMATION FOR USER

CAUTION:

The user changes or modifications not expressly approved by the party responsible for compliance could void the user's authority to operate the equipment.

NOTE:

This equipment has been tested and found to comply with the limits for a Class B digital device, pursuant to Part 15 of the FCC Rules. These limits are designed to provide reasonable protection against harmful interference in a residential installation. This equipment generates, uses and can radiate radio frequency energy and, if not installed and

used in accordance with the instructions, may cause harmful interference to radio communications. However, there is no guarantee that interference will not occur in a particular installation. If this equipment does cause harmful interference to radio or television reception, which can be determined by turning the equipment off and on, the user is encouraged to try to correct the interference by one or more of the following measures:

- Reorient or relocate the receiving antenna.
- Increase the separation between the equipment and receiver.
- Connect the equipment into an outlet on a circuit different from that to which the receiver is connected.
- Consult the dealer or an experienced radio/TV technician for help.

Declaration of Conformity

We, ONKYO EUROPE
ELECTRONICS GmbH
INDUSTRIESTRASSE 20
82110 GERMERING,
GERMANY



declare in own responsibility, that the ONKYO product described in this instruction manual is in compliance with the corresponding technical standards such as EN60065, EN55013, EN55020 and EN61000-3-2, -3-3

GERMERING, GERMANY

A handwritten signature in black ink, appearing to read 'A. Horiuchi', is written over a stylized line.

A.HORIUCHI

ONKYO EUROPE ELECTRONICS GmbH

Memory Preservation

This unit does not require memory preservation batteries. A built-in memory power back-up system preserves the contents of the memory during power failures and even when the unit is unplugged. The unit must be plugged-in in order to charge the back-up system.

The memory preservation period after the unit has been unplugged varies depending on climate and placement of the unit. On the average, memory contents are protected over a period of a few weeks after the last time the unit was unplugged. This period is shorter when the unit is exposed to a highly humid climate.

Precautions

For Canadian model

NOTE: THIS CLASS B DIGITAL APPARATUS COMPLIES WITH CANADIAN ICES-003.

For models having a power cord with a polarized plug:

CAUTION: TO PREVENT ELECTRIC SHOCK, MATCH WIDE BLADE OF PLUG TO WIDE SLOT, FULLY INSERT.

Modele pour les Canadien

REMARQUE: CET APPAREIL NUMÉRIQUE DE LA CLASSE B EST CONFORME À LA NORME NMB-003 DU CANADA.

Sur les modèles dont la fiche est polarisée:

ATTENTION: POUR ÉVITER LES CHOCS ÉLECTRIQUES, INTRODUIRE LA LAME LA PLUS LARGE DE LA FICHE DANS LA BORNE CORRESPONDANTE DE LA PRISE ET POUSSER JUSQU'AU FOND.

For European model

This unit contains a semiconductor laser system and is classified as a "CLASS 1 LASER PRODUCT." So, to use this model properly, read this Instruction Manual carefully. In case of any trouble, please contact the store where you purchased the unit. To prevent being exposed to the laser beam, do not try to open the enclosure.



This label on the left hand panel states that:

1. This unit is a CLASS 1 LASER PRODUCT and employs a laser inside the cabinet.
2. To prevent the laser from being exposed, do not remove the cover. Refer servicing to qualified personnel.

For British model

Replacement and mounting of an AC plug on the power supply cord of this unit should be performed only by qualified service personnel.

IMPORTANT

The wires in the mains lead are coloured in accordance with the following code:

Blue : Neutral
Brown : Live

As the colours of the wires in the mains lead of this apparatus may not correspond with the coloured markings identifying the terminals in your plug, proceed as follows:

The wire which is coloured blue must be connected to the terminal which is marked with the letter N or coloured black.

The wire which is coloured brown must be connected to the terminal which is marked with the letter L or coloured red.

IMPORTANT

A 5 ampere fuse is fitted in this plug. Should the fuse need to be replaced, please ensure that the replacement fuse has a rating of 5 amperes and that it is approved by ASTA or BSI to BS1362. Check for the ASTA mark or the BSI mark on the body of the fuse.

IF THE FITTED MOULDED PLUG IS UNSUITABLE FOR THE SOCKET OUTLET IN YOUR HOME, THEN THE FUSE SHOULD BE REMOVED AND THE PLUG CUT OFF AND DISPOSED OF SAFELY. THERE IS A DANGER OF SEVERE ELECTRICAL SHOCK IF THE CUT OFF PLUG IS INSERTED INTO ANY 13 AMPERE SOCKET.

If in any doubt, please consult a qualified electrician.

Table of contents

Before Using

Thank you for purchasing	2
Important Safeguards	2
Precautions	4
Table of contents	7
Supplied accessories	7
Part names and functions	8
Using the remote controller	11
Notes on usable CDs	12

Connections

Connecting the DX-R700	14
------------------------------	----

Operations

Turning on the power	16
Inserting a disc	17
Recording modes	18
Digital recording/Analog recording	20
Synchronous recording by input digital signal detection	22
Synchronous recording	24
Using the level sync function	26
Changing the display	27
Entering names	28
Finalization	33
Erasing recordings (CD-RW discs only)	34
Playing CDs	38

Other Information

Rules concerning digital recording	42
Display messages	42
Troubleshooting guide	43
Specifications	46

Supplied accessories

Check that the following accessories are supplied with the DX-R700.

- Audio connection cables × 2



- Optical digital cable × 1

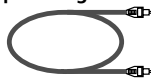

- RI cable × 1



- Remote controller × 1



- Dry-cell batteries (size AA, R06, or UM-3) × 2





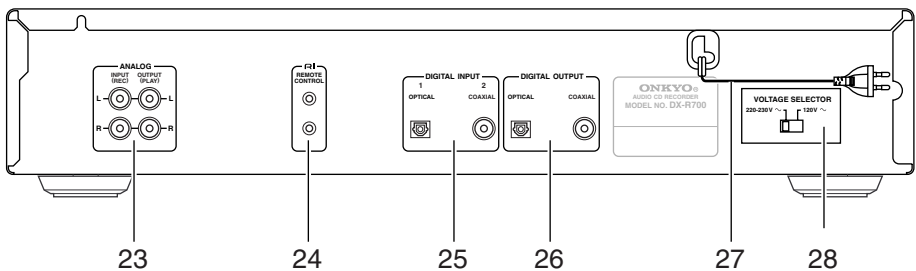
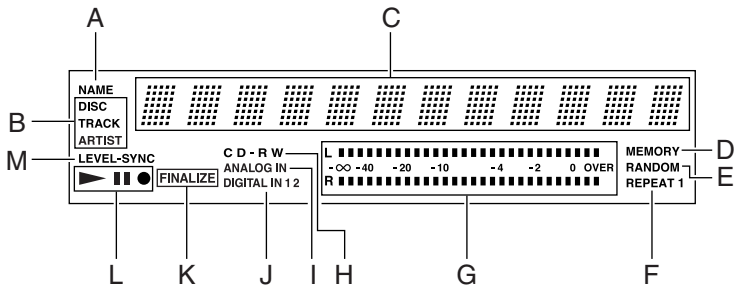
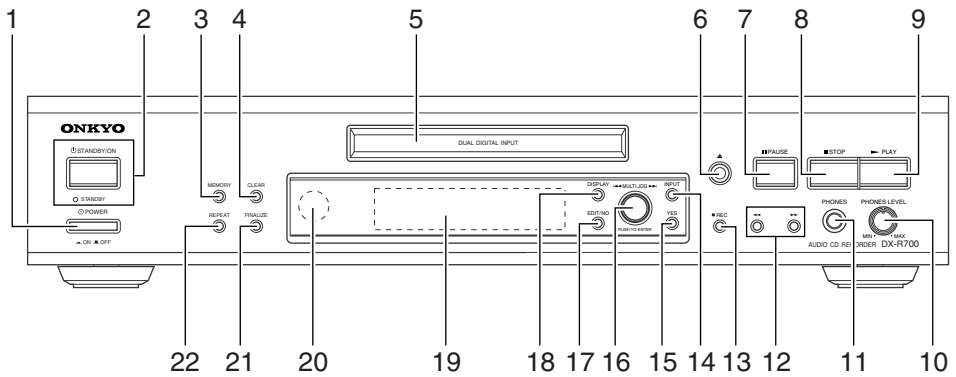







Part names and functions







Part names and functions

The numbers within the brackets are the pages where the part is introduced.

Front panel

- 1 POWER switch (POWER  ON/  OFF) [16]**
Press in to turn on the main power.
- 2 STANDBY/ON button and STANDBY indicator [16]**
Press to turn the DX-R700 on or to put it in standby state while the main power is on (ON). When the DX-R700 enters the standby state, the STANDBY indicator lights.
- 3 MEMORY (programmed playback) button [40]**
Press to program the tracks to play in memory.
- 4 CLEAR button [40]**
Press to erase the programmed tracks one at a time from the end. This button is also used to erase the character entered.
- 5 Disc tray [17]**
- 6  (tray open/close) button [17]**
Press to open and close the disc tray.
- 7  PAUSE button [38]**
Press during playback to pause the playback.
Press the  button to resume playback.
- 8  STOP button [38]**
Press to stop recording or playback.
- 9  PLAY button [38]**
Press to start analog recording, digital recording, and playback.
- 10 PHONES LEVEL dial [41]**
Adjusts the output level for the PHONES jack.
- 11 PHONES jack [41]**
Connects stereo headphones with a standard stereo plug.
- 12 /  (rewind/fast forward) buttons [38]**
Press to rewind or fast forward through the track currently playing.
- 13  REC (recording) button [20, 22, 25]**
For analog and digital recording, press to place the DX-R700 in the recording standby state.
- 14 INPUT button [20, 22, 24]**
Press to select the input source.

- 15 YES button [31-33]**
Press to confirm displayed settings during entering names, finalizing, and other operations.
- 16  MULTI JOG  dial [21, 26, 28-32, 34-38]**
Use to jump to tracks prior to or later than the one currently playing. Use while playback is stopped to select the track to play.
- 17 EDIT/NO button [21, 26, 28, 31, 32, 34-37]**
Press to display the operations for erasing, name input, and other operations. To select a displayed operation, turn the MULTI JOG dial.
- 18 DISPLAY button [27-29]**
Press to change the contents of the display.
- 19 Front display**
 - A NAME indicator
 - B DISC/TRACK/ARTIST indicator
 - C Display
 - D MEMORY (programmed playback) indicator
 - E RANDOM (random playback) indicator
 - F REPEAT (repeat playback) indicator
 - G Recording level display
 - H CD/CD-R/CD-RW indicator
 - I ANALOG IN indicator
 - J DIGITAL IN 1/2 indicator
 - K FINALIZE indicator
 - L  (play) /  (pause) /  (recording) indicator
 - M LEVEL-SYNC indicator
- 20 Remote control sensor [11]**
- 21 FINALIZE button [33]**
Press to finalize discs onto which you have finished recording.
- 22 REPEAT (repeat playback) button [39]**
Press to repeat the playback of a disc or a track.

Rear panel

- 23 ANALOG INPUT (REC)/OUTPUT (PLAY) terminals [15]**
- 24  REMOTE CONTROL terminals [15]**
- 25 DIGITAL INPUT 1 OPTICAL/2 COAXIAL terminals [15]**
- 26 DIGITAL OUTPUT OPTICAL/COAXIAL terminals [15]**
- 27 Power cord [15]**
- 28 VOLTAGE SELECTOR [4] (Worldwide models only)**

Part names and functions

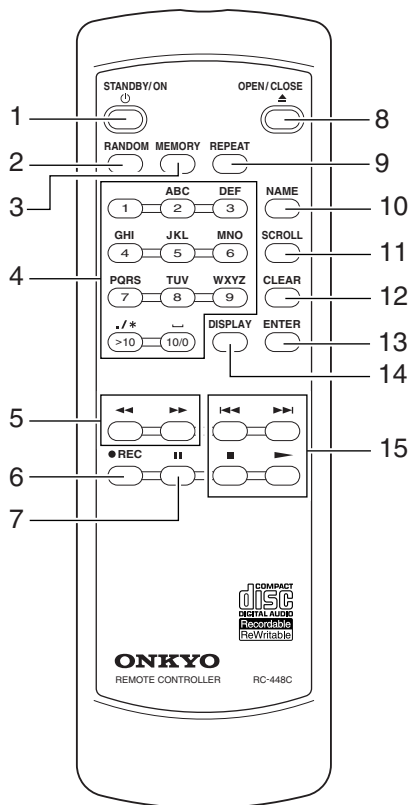

The numbers within the brackets are the pages where the part is introduced.

RC-448C remote controller

- 1 STANDBY/ON button [16]**
While the POWER switch at the DX-R700 is pressed in, press to switch the DX-R700 between the on state and the standby state.
- 2 RANDOM (random playback) button [39]**
Press to playback the tracks on the disc in random order.
- 3 MEMORY (programmed playback) button [40]**
Press to program the tracks to play in memory.
- 4 Numeric buttons [30, 40]**
Press the number for a track to start playback at that track. Also, press to program tracks for programmed playback.

Alphabetic letters/Symbols/Numeric/(1 to 10) buttons [30]

Press to enter a disc name, track titles, and an artist name.

- 5 ◀◀/▶▶ (rewind/fast forward) buttons [30, 38]**
Press to rewind or fast forward through the track currently playing. Press to move the cursor forward or backward when changing the name of a disc.
- 6 ● REC (recording) button [20, 22, 25]**
For analog and digital recording, press to place the DX-R700 in the recording standby state.
- 7 || (pause) button [38]**
Press during playback to pause the playback. Press the ▶ button to resume playback.
- 8 ▲ (tray open/close) button [17]**
Press to open and close the disc tray.
- 9 REPEAT (repeat playback) button [39]**
Press to repeat the playback of a disc or a track.
- 10 NAME button [28, 31, 32]**
Press to begin entering a disc name, artist name, or track titles. Also press this button to confirm the name you input.
- 11 SCROLL button**
Press to scroll a displayed disc name, artist name, or track titles.
- 12 CLEAR button [30]**
Press to erase the programmed tracks one at a time from the end. This button is also used to erase the character entered.
- 13 ENTER button [30]**
Press to enter and confirm a disc name, artist name, or track titles.
- 14 DISPLAY button [27-29]**
Press to change the contents of the display.
- 15 OPERATION button**
 - (stop) button [38]**
Press to stop recording or playback.
 - ▶ (play) button [38]**
Press to start analog recording, digital recording, and playback.
 - ◀◀/▶▶ (skip) buttons [30, 38]**
Use to jump to tracks prior to or later than the one currently playing. Use while playback is stopped to select the track to play.

Using the remote controller

■ Using the RC-448C remote controller

Installing the remote controller batteries

- ① Push the battery cover in the direction of the arrows shown and remove it.

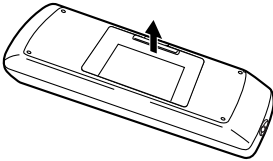

- ② Install the supplied (or AA, R06, or UM-3-sized) batteries into the battery compartment being careful not to mistake the polarity (follow the polarity diagram inside).

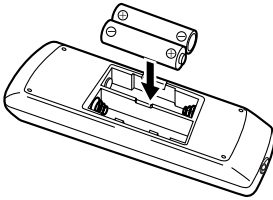

- ③ Replace the battery cover.

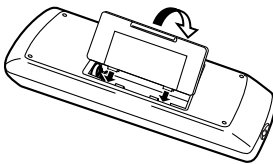

Notes:

- Do not mix new batteries with old batteries or different kinds of batteries.
- To avoid corrosion, remove the batteries if the remote controller will not be used for a long time.
- Immediately remove dead batteries to avoid damage to the remote controller from corrosion. If the remote controller begins to operate improperly, remove the old batteries and replace them with two new batteries.
- The life of the supplied batteries is approx. 1 year, though this value may vary depending on usage.

Using the remote controller

When operating the remote controller, point it toward the remote control sensor of the DX-R700.

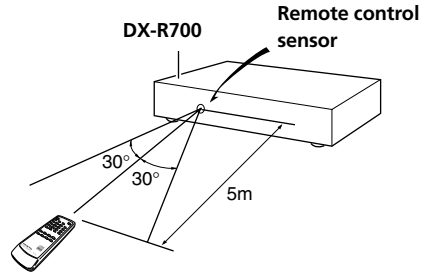

Notes:

- If the remote control sensor is subjected to direct sunlight or inverted fluorescent light, operation of the remote controller may be adversely affected.
- Use of another remote controller nearby or using the remote controller near equipment that uses infrared light may cause operational interference.
- Do not put objects on the remote controller. A button on the remote controller may remain pressed and drain the batteries.
- Make sure the DX-R700 is not placed behind colored glass doors. Placing the DX-R700 behind such doors may prevent proper operation of the remote controller.
- If there is an obstacle between the remote controller and the remote control sensor, the remote controller will not operate.

Notes on usable CDs

Notes on usable discs

- **CD-Recordable (CD-R) and CD-ReWritable (CD-RW) discs**

When recording with the DX-R700, you must use compact discs with the following marks printing on them:



FOR CONSUMER

FOR CONSUMER USE

FOR MUSIC USE ONLY

(A disc with any of the above markings.)

Recording cannot be performed on discs that do not have one of the above markings.

Copyright fees have been enacted by copyright laws, and these fees are included in the price of CD-R*¹ and CD-RW*² discs, as well as discs labeled with "FOR CONSUMER," "FOR CONSUMER USE," and "FOR MUSIC USE ONLY." Therefore, the recording of music protected by copyright laws with these discs is permitted for personal use. However, copying for purposes other than personal use requires the permission of the copyright holder.

- **Compact discs**

Always use compact discs with the following mark (optical digital audio discs):



CD TEXT

CD TEXT is a feature added to audio CDs that provides the ability to deliver text information (alphabetic letters, symbols, and numbers) such as disc titles, artist names, track titles, etc. Commercial audio CDs that contain this text information bear the following mark.



Cautions regarding copyrights

The lyrics and melodies composing the musical elements of media and musical performances from radio broadcasts, compact discs, records, music tapes, original cassettes, and other media are protected equally by copyright law. Therefore, the sale, transition, distribution, and re-release in media-form, or use as background music in stores and the like, is strictly forbidden without the previous express consent from the copyright holder.

CD-R finalization process

After recording onto a CD-R disc, it is necessary to perform the finalization process before the CD-R can be played in CD players. After the finalization process is completed, you cannot perform additional recordings.

CD-ReWritable (CD-RW) discs

CD-RW discs cannot be played in normal CD players even after finalization. CD-RW discs can only be played on players compatible with CD-RW discs. Also, with CD-RW discs, recording can be erased even after finalization.

Notes on usable CDs

Notes on discs

Never use heart-shaped, octagonal, or other special shaped discs as they may damage the internal mechanisms of the DX-R700.



Do not play CD-ROMs intended for computer use or non-audio compact discs. Doing so may cause high-pitched noises or other unpredictable results that may damage speakers, amplifiers, and other connected components.

■ Handling discs

Be careful not to touch the data side of the disc (the side that does not have printing on it). Always hold discs by the edges or by using the hole in the middle.

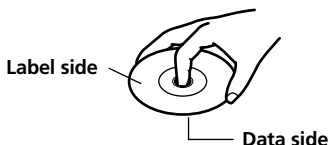

Never place labels or stickers on the data side or label side of the discs. Also, do not write on the discs or allow them to become scratched.



■ Cautions when using rented compact discs

Do not use discs that have cellophane tape attached to them or rental compact discs that have rental labels attached. If the tape is sticking out or peeling off, the disc may not be able to be ejected and the DX-R700 may become damaged.

■ Do not use 8-cm CD adapters

■ Cleaning

Dirt and contaminants on discs can obstruct the pickup of the signals and lead to deterioration of the sound. When dirty, clean the data side with a soft dry cloth, wiping from the inside of the disc toward the outside.



If the dirt is excessive, soak the cloth in water, wring it out, and then wipe the disc surface clean. Next, using a soft dry cloth, wipe the moisture from the disc surface.

Do not use conventional record cleaners or antistatic agents. Also, never use benzene, thinners, or other volatile agents as they may damage the disc surface.

■ Cautions for disc storage

Do not store discs in locations exposed to direct sunlight, near heat emitting devices, and other locations of excessive heat, or locations of extremely low temperatures. Also, always store discs properly in their protective cases.

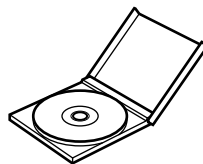

Condensation

When moving the DX-R700 from a cold location to a hot location, when quickly heating a cold location with a furnace, or other similar situation, condensation may occur. This may not only cause improper operation of the device, but may also damage the discs and components.

If condensation has occurred, turn on the DX-R700 and leave it running for 1 to 2 hours. If you will not use the DX-R700, then eject any disc inside.





Connections

Connecting the DX-R700

■ Connecting to other components

The DX-R700 contains components that are extremely heat sensitive, so do not place the DX-R700 on the amplifier.

Always complete all connections before inserting the power cord into the wall outlet.

To L channel of the DX-R700 (White)   (White) To L channel of other component
 To R channel of the DX-R700 (Red)   (Red) To R channel of other component

Protection cap for the optical digital input terminal

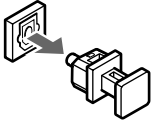

When necessary, remove this protection cap and store it safely. When not using the optical digital input terminal, be sure to put the cap back on the terminal.

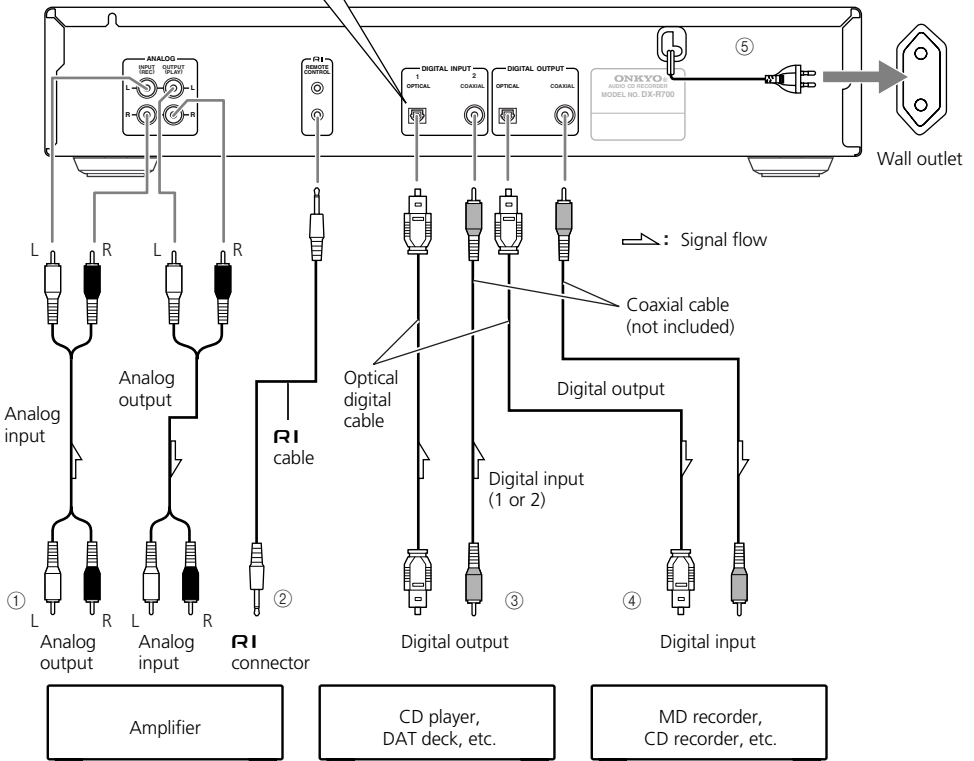
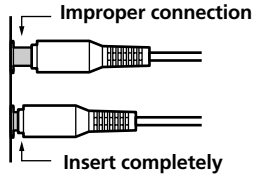

Connecting the DX-R700

① Connecting to an amplifier

Connect the DX-R700 to the CDR, TAPE or MD terminal on the amplifier.

- Connect the red connectors of the supplied audio connection cables to the R-channel terminals and the white connectors to the L-channel terminals.
- Make sure the connectors are properly inserted all the way. If the connectors are not properly connected, noise or improper operation may result.
- Do not bundle the audio cables together with power cords or speaker cables. Doing so may cause deterioration of the audio signal.

② Connecting the **RI** cable

- With Onkyo components that are equipped with an **RI** connector, use the supplied **RI** cable to connect the **RI** connector to the **RI** connector of the DX-R700.
- The **RI** connectors are only effective if they are used in conjunction with an Onkyo amplifier with an **RI** connector. Do not connect to a component other than an Onkyo component with an **RI** connector. Doing so may damage the DX-R700.
- The function of the upper and lower **RI** connectors are the same. Connect to either one.
- Connecting the **RI** cable only does not make the system operational. You must also connect the audio cables as well.

③ Connecting to the digital input

Using the digital input, you can record digital audio from compact disc players, DAT decks, and other digital audio components that have a digital output. Connect using the supplied optical digital cable and either the DIGITAL INPUT 1 or 2 input on the DX-R700. You can also connect to amplifiers that are equipped with digital output terminals.

Notes:

- The optical digital terminal is provided with a protection cap installed. When necessary, remove this protection cap and store it safely. When not using the optical digital input terminal, be sure to put the cap back on the terminal.
- To perform digital input recording, you must connect to the optical digital input terminal. If the digital connection is not made, "D.In Unlock" will appear in the display.

④ Connecting to the digital output

Using the digital output, you can connect to MD recorders, CD recorders, DAT deck recorders, and other digital audio recorders that have optical digital input connectors for making digital recordings. You can also connect to amplifiers that are equipped with digital input terminals.

⑤ Connecting the power cord

Plug the power cord into an AC wall outlet.

Operations

Turning on the power

Connecting the power cord

Before you plug in the DX-R700, confirm that all the other connections have been made properly.

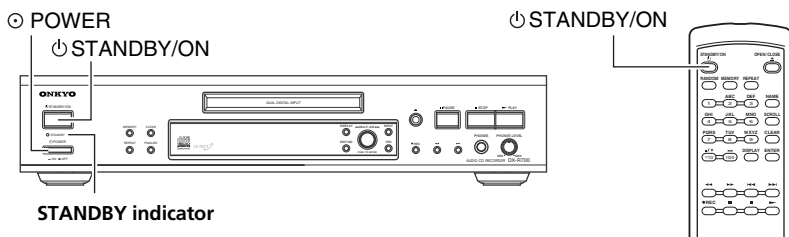

Turning the power on

1 Press the POWER switch.

The recorder returns to the same state as you pressed the POWER switch last time. When you turn the main power on first time, the standby indicator lights and the DX-R700 enters the standby state.

If you turn off the main power last time with the DX-R700 turned on, without pressing the STANDBY/ON button the recorder will be automatically turned on after pressing the POWER switch next time. In this case, if the CD is already loaded, the DX-R700 will automatically start playback.

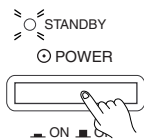

When a malfunction occurs

The DX-R700 employs a microcomputer to realize its advanced features. Although quite rare, occasionally noise from outside the unit, interruption noise, or static electricity may cause a malfunction. If a malfunction occurs, unplug the power cord and after about 5 seconds plug it in again.

Note:

The DX-R700 is shipped with the main power (POWER) switch in the on position. When the power cord is plugged in for the first time, the DX-R700 will automatically enter the standby state and the standby indicator will light (same condition after step 1 on the left).

2 Press the STANDBY/ON button.

The STANDBY indicator goes out and the display panel lights.

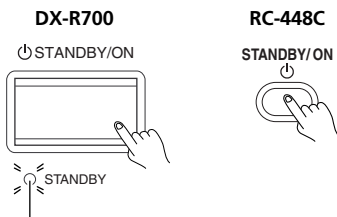

The STANDBY indicator turns off.

Inserting a disc

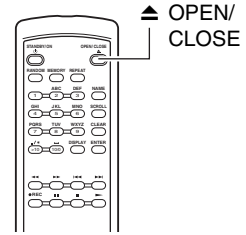
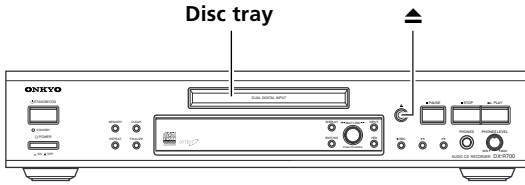

1 Turn on the DX-R700. (See page 16.)

2 Press the ▲ button.

The disc tray opens. Place the disc with the label-side up in the center of the tray.

DX-R700



RC-448C



label-side



3 Press the ▲ button.

The disc tray closes.

Memo:

- You can also press the ► button to close it.
- By pressing the ▲ button in the standby state, the power is automatically turned on.

- When the disc is inserted, the DX-R700 automatically scans the disc and displays the type in the front display.

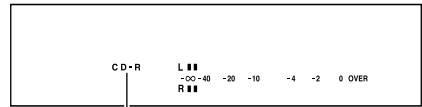

Disc indicator

CD	Commercially sold CD Finalized CD-R
CD-R	Unrecorded CD-R Partly recorded (not finalized) CD-R
CD-RW	Unrecorded CD-RW Partly recorded (not finalized) CD-RW
CD-RW	Finalized CD-RW
FINALIZE	

- The DX-R700 displays information of the disc, including total recording number of tracks and time, and remaining available recording time. Displayed contents may vary depending on the type of disc. When unrecorded compact discs are inserted, "Blank Disc" appears in the display.

Recording modes

Cautions during recording

In the following situations, recording is not possible even if the ● REC button is pressed.

- The CD indicator is lit (a CD or finalized CD-R has been inserted).
- The CD-RW and FINALIZE indicators are lit (a finalized CD-RW has been inserted).
- The inserted disc is full and "Disc Full" is displayed.
- The 99th track has been recorded and "Disc Full" is displayed.
- The disc is not for audio use or when "Pro Disc" is displayed.

Only the audio signals can be recorded

The DX-R700 is designed for recording audio signals only and therefore only digital signals that are audio signals are recorded. Other CD-ROM and Dolby Digital data, and the like, will not be recorded. Also, when recording from discs that have graphics or text data, only the audio signals will be recorded.

The minimum track length is 4 seconds

For compact discs, the minimum track length is 4 seconds. Even if the ■ (stop) or || (pause) button is pressed immediately after starting recording, a silent 4-second track will be recorded. Also, during that 4 seconds, you cannot resume recording or perform another operation.

When an unrecordable signal is present during the digital recording

"D.In Unlock" or "Cannot Copy" appears in the display and the recording operation is suspended. The operation will be resumed in response to any recordable signals that may follow.

Do not turn off the DX-R700 while making recordings, finalizing discs, or erasing recordings, or while "PMA Writing" is displayed

An inserted disc can be corrupt and no longer usable if the power is accidentally turned off or in case of power failure.

Normal recording mode

When not connected to a component system, there are a few methods that you can perform to record the signal in from the analog input or digital input of the DX-R700.

■ Analog recording (see page 20)

This method records the signal at the analog inputs. The recording level can be adjusted manually.

■ Digital recording (see page 20)

This method records the signal at the optical digital inputs. The recording level can be adjusted manually. You may need to adjust the recording level when recording low digital signal sources such as satellite broadcasts and the like.

■ Signal synchronous recording (see page 22)

This method allows you to start recording in synchronization with the input signals from the Onkyo products that are not equipped with an R I connector or other manufacturer's products.

Recording mode when connecting to other Onkyo products using R I cable

When you connect the DX-R700 to other Onkyo products using R I cable, you can use the following recording mode.

■ Synchronous recording on the DX-R700 (The recording on the DX-R700 and the playback on the source device start simultaneously.)

- Synchronous recording from the CD player to the DX-R700
- Synchronous recording from the MD recorder to the DX-R700 (Analog recording only)

Note:

If you want to record digitally from the CD player, you must have the optical or coaxial cable from the CD player connected to the DIGITAL INPUT terminal on the DX-R700.

Recording modes

About the level sync function

The level sync function detects the space between tracks (songs, etc.) in the recording source and automatically assigns track numbers to them during recording.

■ When the level sync function is turned on

The track numbers are updated automatically. Press the ● REC button to set track numbers manually .

■ When the level sync function is turned off

The track numbers are not updated automatically. Press the ● REC button to set track numbers manually .

■ For analog recording

The level sync function automatically turns On. If there are gaps of no sound 2 seconds or longer between tracks in the recording source, the track numbers will be automatically updated.

■ For digital recording

The level sync recording automatically turns on. If the digital signal includes the track number information, the track numbers will be automatically assigned.

For satellite broadcasts and other digital signals that do not include track number information, the track numbers will be automatically updated when 2 seconds or more of silence is detected.

Name function

■ Entering a disc name or artist name (see page 28)

You can enter one disc name and one artist name per disc.

■ Entering track names (see page 31)

You can enter up to 99 track names per disc.

■ Erasing the disc name, artist name, and track names (see page 32)

You can erase all the name information retained in the DX-R700.

Finalization

The finalization process writes the TOC data (tracks, etc.) for the disc in a special area on the disc called the PMA. After finalization, CD-Rs can be played in CD players. Even after finalization, CD-RWs can only be played on CD players that are compatible with CD-RWs.

For CD-Rs that have been finalized, you cannot add more recordings.

Erasing recording (CD-RW discs only)

The data recorded on CD-RW discs can be erased and the disc can be used again as many times as desired (see page 34).

The erasing methods are given below.

• Erasing data on unfinalized CD-RWs

Last track erase: Erases only the last track.

Multi-track erase: Erases all tracks from the selected track to the final track.

All track erase: Erases all tracks.

• Erasing data on finalized CD-RWs

All track erase: Erases all tracks.

TOC erase: Returns a finalized disc to the unfinalized conditions.

• Erasing discs

Erases all data recorded on the CD-RW.

Digital recording/Analog recording

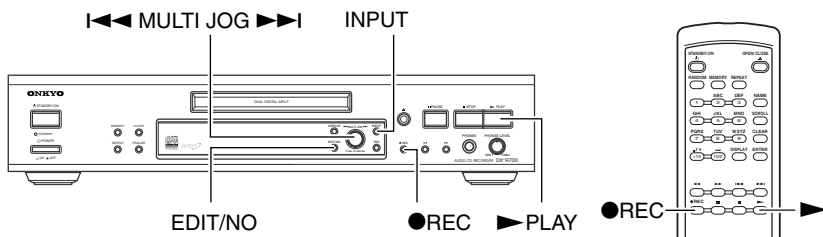

You can perform digital recording to record the signal input to the digital input terminals or analog recording to record the signal input to the analog input terminals. The recording level can be adjusted manually.

Types of digital source that can be recorded

The DX-R700 contains an internal sampling rate converter, and therefore can record digital signals of the sampling rates given below.

- 44.1 kHz (CDs, etc.)
- 32 kHz (DAT, satellite broadcasts, etc.)
- 48 kHz (DAT, satellite broadcasts, etc.)

Note:

When performing a digital recording from HDCDs, DTS CDs, and the like, be sure to set the recording level to 0 dB (see page 21).

Preparation

- Turn on the DX-R700 (see page 16).
- Place a recordable CD-R or CD-RW in the DX-R700 (see page 17).
- Verify that the input dial and recording selection button of the amplifier are set to the position of the recording source.

1 Repeatedly press the INPUT button until "Digital In 1", "Digital In 2" or "Analog In" appears.

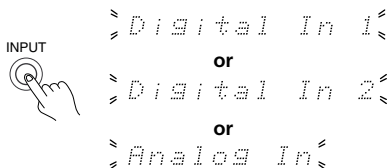

Proceed to step 3 if you do not wish to adjust the recording level

Note:

Verify to which digital input the optical digital cable is connected.

2 Start playback of the recording source.

3 Press the ● REC button.

The level sync function is set to On (see page 26). "Rec setup" appears in the display followed by the time display (the recording standby state).

DX-R700



RC-448C



Proceed to step 6 if you do not wish to adjust the recording level.

Note:

When you select the digital input but the digital cable is not connected to the DX-R700, "D.InUnlock" will appear.

Digital recording/Analog recording

4 Adjust the recording level.

- (1) Press the EDIT/NO button and turn the MULTI JOG dial until "Rec Level?" appears.

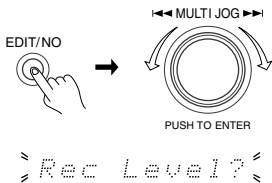

- (2) Press the MULTI JOG dial.

Pressing the YES button provides the same operation.
Press the EDIT/NO button if you cancel the adjustment operation.

- (3) Turn the MULTI JOG dial to adjust the recording level as desired.

The current level is displayed, ranging from $-\infty$ to +20 dB.



For analog recording

Adjust so that when the recording level is at its highest, it does not reach "OVER" in the front display. If OVER is reached, the sound becomes distorted.

Adjust the level so that "OVER" will not light.

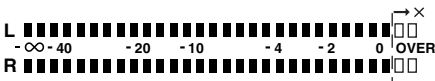

For digital recording

Adjust so that when the recording level is at its highest, the peak level should indicate between -6 dB and -2 dB in the front display.

Adjust the level so that this range should light.

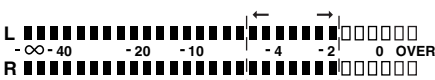

Even if you change the recording level, the monitor sound level from the DIGITAL OUT terminals will not change.

- (4) After adjusting the recording level, press the MULTI JOG dial.

Pressing the YES button provides the same operation.



5 Stop the playback of the recording source.

6 Press the ► button and start the recording source.

Recording starts. The track numbers are automatically recorded. After the recording reaches the end of the disc, the DX-R700 will stop.

To set the track numbers manually

Press the ● REC button.

To pause the recording

Press the ■ button. To resume recording, press the ► button when the time display appears. If the entire disc becomes filled with recordings, the DX-R700 automatically stops.

To stop the recording

Press the ■ button.

Notes:

- When digitally recording satellite broadcasts, the track numbers may not be assigned properly. If this occurs, turn off the level sync function and set the track numbers manually (see page 26).
- If the time between tracks is extremely short, the track numbers may not be assigned properly.

Synchronous recording by input signal detection (Signal synchronous recording)

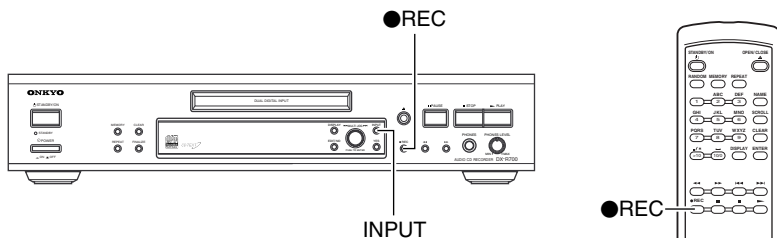

This method allows you to start recording in synchronization with the input signals from the Onkyo products that are not equipped with an **RI** connector or other manufacturer's products. When recording with the Onkyo products equipped with an **RI** connector, refer to "Synchronous recording" on page 24.

Notes:

Note the following when using synchronous recording for digital input sources.

- Sources other than CDs, MDs, DATs, and DCCs cannot be recorded.
- DATs and DCCs cannot be recorded if no start ID is present before audio contents.
- Synchronous recording uses a sub-code signal that is contained in the digital output from most player components, and therefore there may be some CD players, MD recorders, or the like where digital synchronous recording is impossible.

Preparation

- Turn on the DX-R700 (see page 16).
- Place a recordable CD-R or CD-RW in the DX-R700 (see page 17).
- Verify that the input dial and recording selection button of the amplifier are set to the position of the recording source.

1 Repeatedly press the INPUT button and select the desired input signal.

Select "Digital In 1," "Digital In 2," or "Analog In" for the input source.



Proceed to step 3 if you do not wish to adjust the recording level.

2 Start playback of the recording source.

3 Press the ● REC button.

"Rec Setup" appears in the display followed by the time display.

DX-R700



RC-448C



Proceed to step 6 if you do not wish to adjust the recording level.

Synchronous recording by input signal detection

(Signal synchronous recording)

4 Adjust the recording level.

Refer to page 21, step 4 “Adjust the recording level.”

5 Stop the playback of the recording source.

6 Press the ● REC button.

The DX-R700 enters the input standby state, “Signal Rec” appears in the display, and then “Signal Wait” appears flashing alternately with the time display.

DX-R700



RC-448C



Note:

If “Check Level” flashes and recording does not start, then the recording source was likely already playing and not allowing recording to start. First stop the recording source and then resume operations.

7 Verify that “Signal Wait” is flashing together with the time display and then start the playback of the recording source.

Recording starts as soon as the DX-R700 receives signals from the recording source.

Auto finalization

To use auto finalization, press the FINALIZE button repeatedly during recording until “Auto On” appears. (The FINALIZE indicator appears flashing.) Finalization starts automatically when the DX-R700 is set in the state of “Signal Wait” for 1 minute after interruption of the input signal.

- **If “Name Disc” appears when you press the FINALIZE button**

You cannot use auto finalization. This is because the disc has track names but it has no disc name.

Follow the steps below to finalize.

1. Enter a disc name after recording completes (see page 28).
2. Press the FINALIZE button to finalize the disc (see page 33).

To cancel auto finalization

Press the FINALIZE button repeatedly until “Auto Off” appears. (The FINALIZE indicator disappears.)

Notes on the signal synchronous recording

- When the level sync function is turned on during analog recording, the track numbers are updated automatically as soon as audible sound is detected after 2 seconds or more of silence.
- If placed in the state of “Signal Wait” for 1 minute, the DX-R700 enters the recording standby state with the signal synchronous recording canceled.
When the auto finalization is turned on, finalization automatically starts.
- When “D.In Unlock” appears in the front display during the signal synchronous recording (digital input), the DX-R700 cancels the recording mode and enter to the recording standby state.
- When the signal synchronous recording is performed with an Onkyo CD player connected to the DX-R700 using the **RI** terminal, pressing the stop button on the CD player will not stop the DX-R700, but place it in the “Signal Wait” state.

Synchronous recording

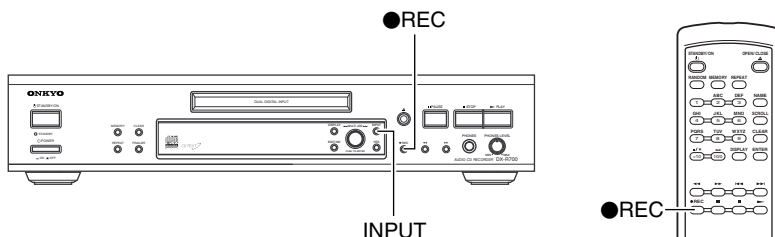

When you connect the DX-R700 to other Onkyo products using **RI** cable, you can use the following recording mode.

- Synchronous recording from the CD player to the DX-R700.
- Synchronous recording from the MD recorder to the DX-R700.

Synchronous recording to the DX-R700

Preparation

- Turn on the DX-R700 (see page 16).
- Prepare the source device for playback. (Load the MD or CD into the MD player or the CD player respectively.)
- Place a recordable CD-R or CD-RW in the DX-R700 (see page 17).

1 Repeatedly press the **INPUT** button until “Digital In 1” or “Analog In” appears.

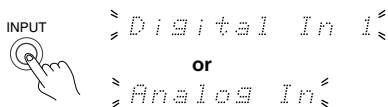

- For digital recording from the CD player, select “Digital In 1.” For analog recording, select “Analog In.”
- For recording from the MD recorder, select “Analog In.” If you select “Digital In 1” or “Digital In 2” for this case, the synchronous recording function is disabled.
- In any recordings above, selecting “Digital In 2” will disable the synchronous recording function. In this case, use the signal synchronous recording function instead (see page 22).
- Proceed to step 3 if you do not wish to adjust the recording level.

2 Press the play button on the source device to start the playback.

Synchronous recording

3 Press the ● REC button.

DX-R700



RC-448C



“Rec Setup” appears in the display followed by the time display (the recording standby state). Proceed to step 6 if you do not wish to adjust the recording level.

4 Adjust the recording level.

Refer to page 21, step 4 “Adjust the recording level.”

5 Stop the playback of the source device.

6 Press the play button on the source device to start the playback.

Playing starts and recording starts at the DX-R700.

When the playback finishes

Only when you perform the digital synchronous recording from the CD player, the DX-R700 will go into the recording standby state. After the recording standby state lasts 10 minutes, the DX-R700 will stop automatically.

In any other recordings, you will have to stop the recording manually using the ■ STOP button on the DX-R700.

To stop the synchronous recording

Press the ■ STOP button on the DX-R700. When you are performing the digital synchronous recording from the CD player, the stop of the CD playback will cause the DX-R700 to enter the recording standby state.

While performing analog recording, do not switch the input selector control on the amplifier.

Using the level sync function

Using the level sync function

During analog recording, the track numbers are assigned automatically since the level sync function is turned on. Even so, you can press the ● REC (or the remote controller ● REC button) to assign the track numbers manually. To disable the automatic assignment of track numbers during recording, turn off the level sync function.

Turn off the level sync function and assign the track numbers manually, if the numbers are not automatically updated due to the situations as follows:

For analog recording

The level sync function uses the recording source level to detect the end and beginning of tracks. Therefore, in the cases given below, the track numbers may not be properly assigned.

- The recording on the cassette tape is poor (e.g., the space between songs contains much noise).
- With music such as classical music where there may be very low volumes.
- Where the space between songs is extremely short.
- If the signal at the tuner is weak (excessive noise).
- When recording from turntables.

For digital recording

- When digitally recording satellite broadcasts, the track numbers may not be assigned properly. If this occurs, turn off the level sync function and set the track numbers manually (see page 21).
- If the time between tracks is extremely short, the track numbers may not be assigned properly.

- 1** During recording or while in the recording standby state, press the **EDIT/NO** button and turn the **MULTI JOG** dial until “Level Sync?” appears.

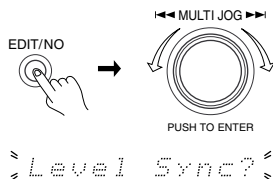

- 2** Press the **MULTI JOG** dial.

Pressing the YES button provides the same operation.

The current setting appears. The current setting is given on the left side (for the display given below, the current setting is “On”).

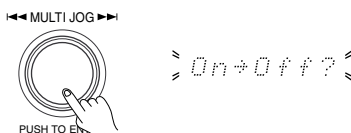

- 3** Press the **MULTI JOG** dial.

Pressing the YES button provides the same operation.

The level sync function turns off. Press the EDIT/NO button to return to the previous setting.

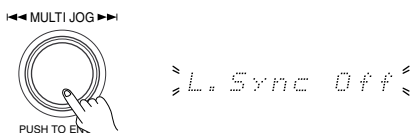

To return to automatic assignment of track numbers

Switch the setting to On.

Follow the steps 1 through 3. “Off → On?” should appear in step 2, “L.Sync On” in step 3.

Changing the display

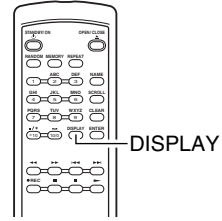
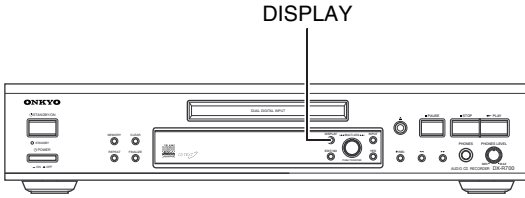

Display during recording

Repeatedly pressing the DISPLAY button during recording changes the display as shown below.

DX-R700

DISPLAY



RC-448C

DISPLAY



■ Display during recording

Track number and elapsed time of track being recorded



Remaining available recording time



Track name (Track number and "No Name" if unavailable)

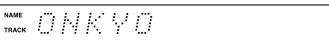

(Return to first display)

■ Display while stopped

Total number of tracks and time of the disc



Remaining available recording time (Not displayed for audio CDs and finalized discs)

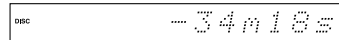

Disc name ("No Name" if unavailable)

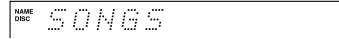

Artist name

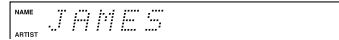

(Return to first display)

■ Display during playback

Track number and elapsed time of track being played



Track number and remaining time of track being played



Remaining time of total time of the disc

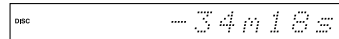

Track name (Track number and "No Name" if unavailable)

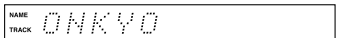

(Return to first display)

Entering names

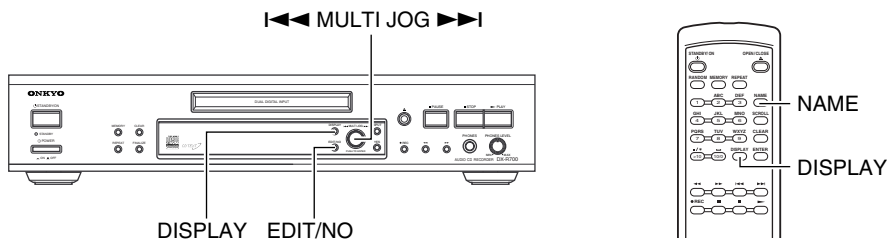

Name function

- The name function can be used for non-finalized CD-Rs or CD-RWs. You cannot enter names on finalized discs.
- The names you can enter include the disc name, artist name, and track names.
- You can enter one disc name, one artist name, and up to 99 track names per disc. A disc, artist, or track name can consist of up to 100 characters. You can enter up to 1000 characters per disc.
- Finalization is required to write entered names to the disc. (The names you enter are temporarily retained in the DX-R700 and then written to the disc during finalization.)

Entering a disc name or artist name

When entering a disc name or artist name, set the DX-R700 to the stop state in advance.

1 Press the DISPLAY button to switch the display.

When entering a disc name, switch to the display except the artist name.

When entering an artist name, switch to the artist name.

DX-R700

DISPLAY



RC-448C

DISPLAY



(Disc name is displayed) (Artist name is displayed)

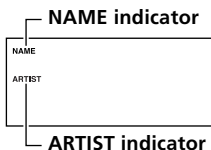
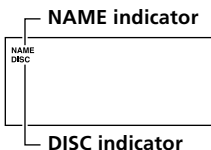

2 Press the EDIT/NO button and turn the MULTI JOG dial until "Name In?" appears.

To cancel name input, press the EDIT/NO button again or the ■ STOP button.

DX-R700

MULTI JOG

EDIT/NO



PUSH TO ENTER

» Name In? «

RC-448C

NAME



Or, press the remote controller NAME button. Pressing the NAME button proceeds to the state after step 3 is complete (go to step 4).

If "Erase Name" appears when entering a name

The DX-R700 retains the name information for a previous disc, preventing you from entering names for the new disc. Before entering names, erase the retained name information (see page 32), or insert the previous disc, perform finalization, and then replace it with the new disc.

3 Press the MULTI JOG dial.

MULTI JOG



PUSH TO ENTER

Pressing the YES button provides the same operation. The cursor appears flashing. To stop entering names while the cursor is flashing, press the YES button with holding the EDIT/NO button pressed, or press the ■ STOP button.



Entering names

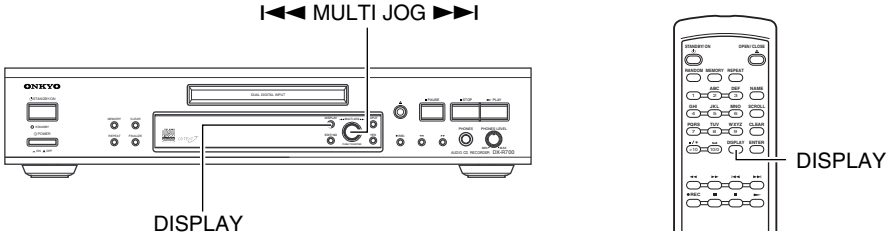

4 Enter a name.

(1) Press the DISPLAY button to select the type of characters you wish to enter.

DX-R700

DISPLAY



RC-448C

DISPLAY



Repeatedly pressing the DISPLAY button changes the type of input characters as shown below.

Upper-case letter of alphabet (Indication: A)

↓

Lower-case letter of alphabet (Indication: a)

↓

Numbers and symbols (Indication: 1)

↓

Easy name (Indication: ♪)

Types of available characters and symbols

A B C D E F G H I J K L M N O P Q R S T U V W X
Y Z

a b c d e f g h i j k l m n o p q r s t u v w x y z

0 1 2 3 4 5 6 7 8 9 _ @ ' < > # \$ % & * = ; : +

- / () ? ! ' " , . (Space) ►► (Insertion)

Types of available easy names

BALLAD, BLUES, CLASSIC, DANCE, FUSION,
JAZZ, LIVE, POPS, REGGAE, ROCK, SOUL,
TECHNO, VOCAL, African, American, Asian,
British, Euro, German, Japanese, Anthology,
Best of*, Collection, Favorite, Happy, Heavy,
Hit Songs, Omnibus, Selection, Special, Super,
(Space)

* One space will be added automatically as you enter "of."

(2) Turn the MULTI JOG dial to select the desired character and press the MULTI JOG dial to enter it.

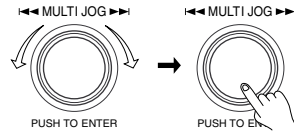

To change the type of input characters

Press the DISPLAY button and select the type of input characters in the above step 4-(1) before turning and pressing the MULTI JOG dial to enter characters.

(Continued to the next page)

Entering names

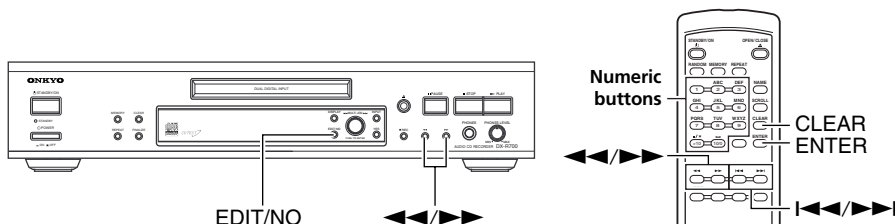

(continued)

Using the remote controller (RC-448C) for entering names

• Entering an alphabetic character

Press the desired numeric button to sequentially display the characters indicated on it. For example, pressing the 2/ABC button each time changes the displayed character in the sequence of A→B→C→A. When the character you want appears, press the ENTER button.

• Entering an easy name

Press the desired numeric button to sequentially display the easy names by the initial letters indicated on it. For example, pressing the 2/ABC button each time changes the displayed easy name to BALLAD, BLUES, CLASSIC, and so on. When the easy name you want appears, press the ENTER button.

• Entering a number or symbol

Press the desired numeric button to display the number indicated on it. Or, repeatedly press the >10.//* button to change displaying the desired symbol, ./*-;!?(), in that order, and press the 10/0/- button to display a space. When the number or symbol you want appears, press the ENTER button.

You may select the desired character using the I◀◀ or ▶▶I button and press the ENTER button to enter it.

Note:

Using the remote controller to enter symbols

You may not be able to enter some symbols using the remote controller numeric buttons. To enter a symbol, select it using the remote controller I◀◀ or ▶▶I button.

To correct an input character

Press the ◀◀ or ▶▶ button on the DX-R700 or the remote controller. While the character you wish to correct appears flashing, enter a correct character.

To insert a character

Press the ◀◀ or ▶▶ button on the DX-R700 or the remote controller. When the position where you wish to insert a character appears flashing, turn the MULTI JOG dial counterclockwise (▶◀ appears flashing) and press the MULTI JOG dial. Enter a correct character at the position where the cursor is flashing.

To erase a character

Press the ◀◀ or ▶▶ button on the DX-R700 or the remote controller. When the character you wish to erase appears flashing, press the EDIT/NO button or the remote controller CLEAR button.

Entering names

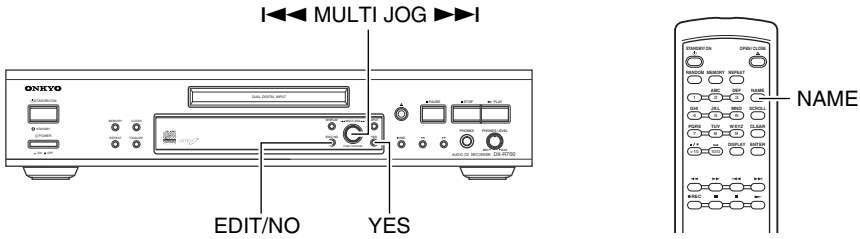

5 Press the YES button to end name input.

Or, press the NAME button on the remote controller (RC-448C).

DX-R700

YES



RC-448C

NAME



≡ Complete ≡

To write the entered names to the disc

Finalize the disc (see page 33).

The names you enter are temporarily stored in the DX-R700 and then written to the disc during finalization. Be aware of the following notes when finalizing a disc.

Notes:

- The name information for the disc is left in the DX-R700 if you have ejected the disc without finalizing it. In this case, even if you insert a new disc and attempt to enter names for it, "Erase Name" will appear and the attempt will fail. To solve this, erase the retained names (see page 32) or insert the previous disc, finalize it, and then replace it with the new disc.
- You cannot finalize the disc if it has no disc name.
- If you enter names for a blank disc and eject it without recording, the name information will not be retained in the DX-R700.
- You cannot enter names for the disc during auto finalization.

Entering track names

1 Turn the MULTI JOG dial to select the desired track.

During playback, pause, or recording, the track selected currently will be named.

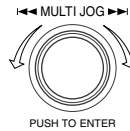

2 Press the EDIT/NO button and turn the MULTI JOG dial until "Name In?" appears.

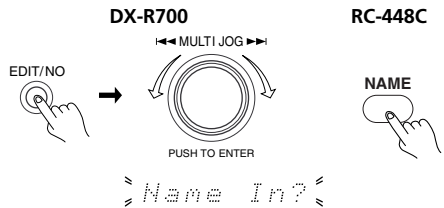

Or, press the remote controller NAME button. Pressing the NAME button proceeds to the state after step 3 is complete (go to step 4).

Entering names

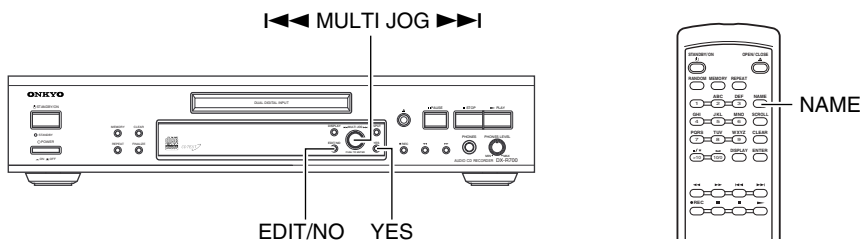

3 Press the MULTI JOG dial.

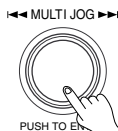

Pressing the YES button provides the same operation. The cursor appears flashing. To stop entering names while the cursor is flashing, press the YES button with holding the EDIT/NO button pressed, or press the ■ STOP button. Enter a track name in the same method as that described in step 4 of "Entering a disc name or artist name" (see page 29).

4 Press the YES button to end name input.

With the RC-448C remote controller, press the NAME button.

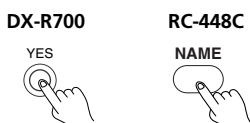

To write the entered names to the disc

Finalize the disc. The names you enter are temporarily stored in the DX-R700 and then written to the disc during finalization. Be aware of the following notes when finalizing a disc.

Notes:

- The name information for the disc is left in the DX-R700 if you have ejected the disc without finalizing it. In this case, even if you insert a new disc and attempt to enter names for it, "Erase Name" will appear and the attempt will fail. To solve this, erase the retained names or insert the previous disc, finalize it, and then replace it with the new disc.

- You cannot finalize the disc if it has no disc name.
- If you enter names for a blank disc and eject it without recording, the name information will not be retained in the DX-R700.
- You cannot enter names for the disc during auto finalization.

Erasing the disc name, artist name, and track names

Follow the steps below to erase all the name information retained in the DX-R700. Set the DX-R700 to the stop state in advance.

1 Press the EDIT/NO button and turn the MULTI JOG dial until "Name Erase?" appears.

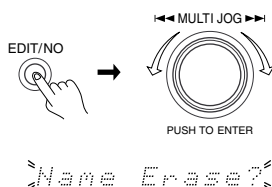

2 Press the MULTI JOG dial.

Pressing the YES button provides the same operation. When completed, "Complete" appears in the display and the DX-R700 will stop. See page 36 to erase the names written to a (finalized) CD-RW.

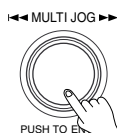

Finalization

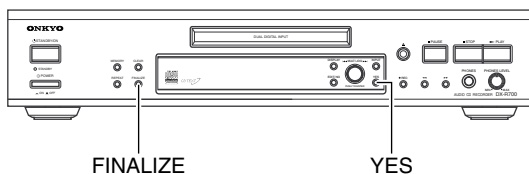

Finalization is a process of writing the TOC data (track numbers etc.) and the name information retained in the DX-R700 to the special area (PMA) of the disc.

After finalization

CD-Rs can be played in CD players. Even after finalization, CD-RWs can only be played on CD players that are compatible with CD-RWs. For finalized CD-Rs, you cannot add more recordings and name information.

When finalization finishes

The DX-R700 automatically stops.

To stop the finalization process

Press the **■** STOP button or the EDIT/NO button (before pressing the YES button in step 3).

Display after finalization

For CD-Rs, the display becomes that for CDs. For CD-RWs, the display does not change, except that FINALIZE is added.

1 Insert the CD-R or CD-RW to be finalized into the DX-R700.

2 Press the FINALIZE button.



After showing "Finalize," the display shows, for example, "Ok? -1m58s" together with the time information.

Memo:

The DX-R700 will stop, if this state persists for 10 minutes or more.

3 After the time information appears, press the YES button.



Finalization begins. During finalization, the remaining time is displayed. (Finalization takes approx. 2 minutes.)

Notes:

- You cannot finalize your disc which may have an artist name or track titles but no disc name on it. With such a disc, "Name Disc" will appear when you press the FINALIZE button. In this case, enter a disc name before finalizing the disc (see page 28).
- Never turn off the power or remove the power cord during finalization. Doing so may damage all the data on the disc. An inserted disc can be corrupt and no longer usable if the power is accidentally turned off or in case of power failure.
- Never finalize discs that are scratched, dirty, or dusty. Doing so may prevent the process from being properly completed. If the process does not finish in 10 minutes, press the **■** STOP button and abort the process. This disc will not be able to be played with normal CD players.
- During finalization, the operation button on the DX-R700 will be disabled.

Auto finalization

You can perform auto finalization during synchronous recording by input signal detection (see page 22). When auto finalization is turned on, finalization occurs automatically at the end of recording. For details, refer to the applicable pages.

Erasing recordings (CD-RW discs only)

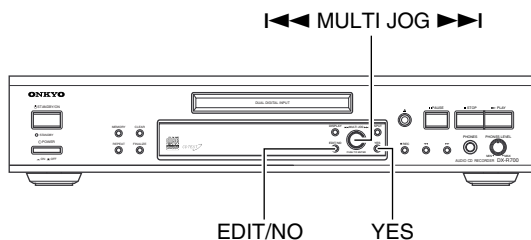

The data recorded on CD-RW discs can be erased and the disc can be used again as many times as desired. The erasing methods are given below.

■ Erasing data on unfinalized CD-RWs

Last track erase: Erases only the last track.

Multi-track erase: Erases all tracks from the selected track to the final track.

All track erase: Erases all tracks.

■ Erasing data on finalized CD-RWs

All track erase: Erases all tracks.

TOC erase: Returns a finalized disc to the unfinalized condition.

■ Erasing discs

Erases all data recorded on the CD-RW.

Notes:

- If "Disc Error" appears during an erase, abort the erase and check the disc for scratches, dirt, or dust. After removing any dirt or dust that may exist, resume the erase.
- After performing an erase, always remove the disc before turning off the power. If the disc is left inside when the power is turned off, there is a chance the erase may be left uncompleted.

Erasing data on non-finalized CD-RWs

Insert the CD-RW you wish to erase and place the DX-R700 in the stop state.

■ Erasing all tracks

This operation will erase all recorded tracks and entered names (the disc name, artist name, and/or track titles) in the CD-RW disc.

- 1 Press the EDIT/NO button and turn the MULTI JOG dial until "All Erase?" appears.**

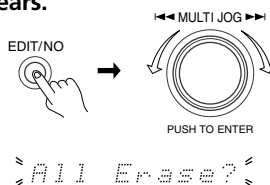

- 2 Press the MULTI JOG dial.**

Pressing the YES button provides the same operation. "All Erase??" appears.



- 3 Press the MULTI JOG dial.**

Pressing the YES button provides the same operation.

Erasing begins. When completed, "Complete" appears in the display and the DX-R700 will stop.



Erasing recordings (CD-RW discs only)

■ Erasing the last track or tracks from the selected track to the last track

1 Turn the MULTI JOG dial and select the track to be erased.

If the selected track is the last track

The last track and, if available, its track name will be erased.

If the selected track is not the last track

All tracks from the selected track to the last track and, if available, their track names will be erased.

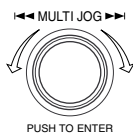

2 Press the EDIT/NO button and turn the MULTI JOG dial until "Erase?" appears.

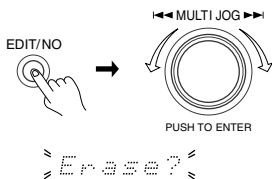

3 Press the MULTI JOG dial.

Pressing the YES button provides the same operation.

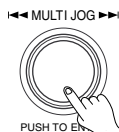

If the selected track is the last track

"Erase Last?" appears.

If the selected track is the first track

"Erase All?" appears. Pressing the YES button at this point will erase all tracks from the first track up to the last track.

If the selected track is neither of the above

"Ers: (Selected track number)-(Last track number)?" appears.

4 Press MULTI JOG dial.

Pressing the YES button provides the same operation.

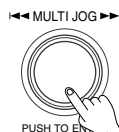

If the selected track is the last track

"Erase Last??" appears.

If the selected track is the first track

All tracks from the first track up to the last track will be erased.

Further, the disc name and artist name retained in the unit will be erased when the disc is ejected.

If the selected track is neither of the above

"Ers: (Selected track number)-(Last track number)?" appears.

5 Press the MULTI JOG dial.

Pressing the YES button provides the same operation.

Erasing begins. When completed, "Complete" appears in the display and the DX-R700 will stop.

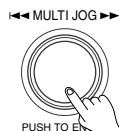

Erasing recordings (CD-RW discs only)

Erasing data on finalized CD-RWs

■ Erasing all tracks

- 1 Press the EDIT/NO button and turn the MULTI JOG dial until "Erase?" appears.

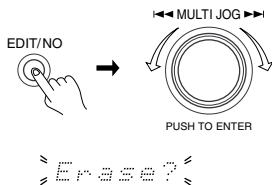

- 2 Press the MULTI JOG dial.

Pressing the YES button provides the same operation.

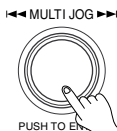

- 3 Turn the MULTI JOG dial until "All Erase?" appears.



- 4 Press the MULTI JOG dial.

Pressing the YES button provides the same operation.

Erasing begins. When completed, "PMA Writing" appears in the display followed by "Blank Disc."



■ Unfinalizing the disc

- 1 Press the EDIT/NO button and turn the MULTI JOG dial until "Erase?" appears.

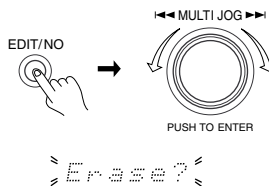

- 2 Press the MULTI JOG dial.

Pressing the YES button provides the same operation.

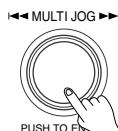

- 3 Turn the MULTI JOG dial until "TOC Erase?" appears.



- 4 Press the MULTI JOG dial.

Pressing the YES button provides the same operation.

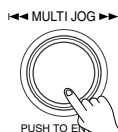

Erasing recordings (CD-RW discs only)

If CD TEXT is not written on the disc

TOC erasing begins.

If CD TEXT is written on the disc

"Name Load?" appears in the display.

- To make CD TEXT retained in the DX-R700, press the YES button, which initiates the TOC erasing. After TOC is erased, CD TEXT is retained in the DX-R700.

Note:

New disc identification data will overwrite any existing data retained in the DX-R700.

- If you do not wish to make CD TEXT retained in the DX-R700, press the EDIT/NO button, which initiates the TOC erasing.

After TOC is erased

"PMA Writing" appears in the display and the DX-R700 will stop.

To force to stop erasing

Press and hold the ■ STOP button for 10 seconds. Remember that the disc is not normally erased and must be fully erased (see below) before it is used.

Erasing entire disc

1 Insert the CD-RW to be erased.

2 Press the EDIT/NO button and turn the MULTI JOG dial until "Initialize?" appears.

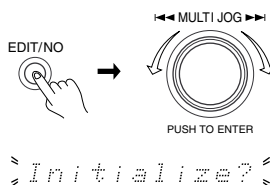

3 Press the MULTI JOG dial.

Pressing the YES button provides the same operation.

"Initialize??" appears.

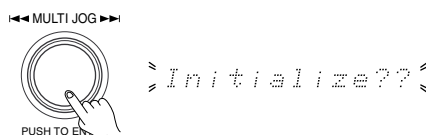

4 Press the MULTI JOG dial.

Pressing the YES button provides the same operation.

A display conforming the erase appears and erasing begins.

The time remaining for the erase appears.

This process requires an amount of time equal to about one half of the total recording time of the disc. When the erasing is completed, "Blank Disc" appears.

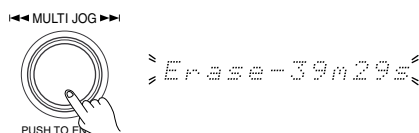

Stopping an erase

Press the ■ STOP button for approx. 10 seconds.

The recording will not properly be erased, so be sure to perform the erase again.

Playing CDs

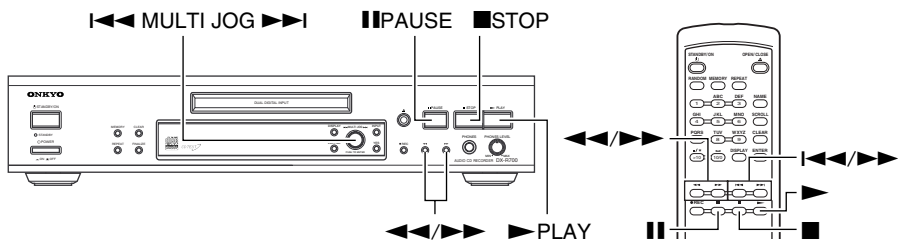

The DX-R700 is capable of four different styles of playback.

- Normal playback
- Random playback
- Repeat playback
- Programmed playback

Preparation

- Turn on the DX-R700 (see page 16).
- Place the CD or recorded CD-R or CD-RW in the DX-R700 (see page 17).

Normal playback

Press the ► button.

Playback starts at track 1.

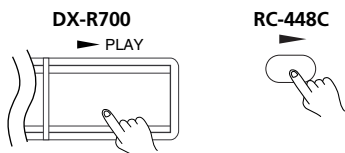

To pause playback

Press the || button. To resume playback, press the ► button.

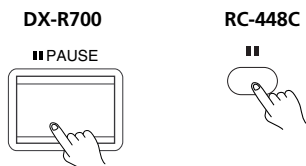

To stop playback

Press the ■ button.

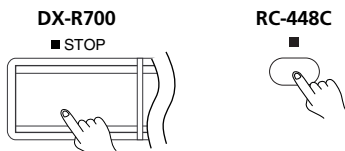

To skip to specific track

Turn the MULTI JOG dial to the left or right and select the desired track. With the remote controller, press the I◀◀ or ▶▶I button.

I◀◀: Press once to skip to the beginning of the track currently being played. Press twice in succession to skip to the beginning of the previous track.

▶▶I: Press once to skip to the beginning of the next track.

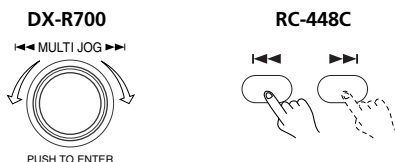

To fast forward or rewind (search)

Press the ◀◀ or ▶▶ button.

◀◀: Press for rewind.

▶▶: Press for fast forward.



To play a specific track

Press the number of the desired track with the numerical buttons on the remote controller to start playback from that specific track (see page 40).

Playing CDs

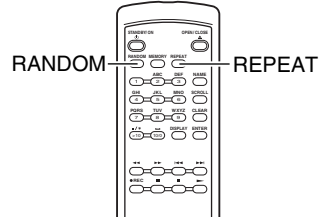
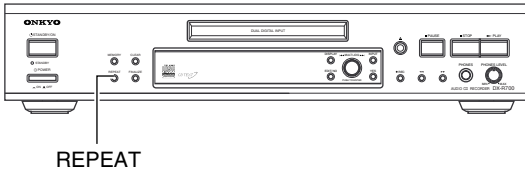

Random playback

With playback stopped, press the RANDOM button

When you press the ► button, the random playback mode plays all the tracks on the disc in random order. The RANDOM indicator lights.

RC-448C

RANDOM



To stop the random playback mode

With playback stopped, press the RANDOM button.

Note:

While in the random playback mode, the numerical buttons do not operate. The EDIT/NO button will not work when the RANDOM indicator lights.

Repeat playback

Press the REPEAT button as many times as desired

Selecting "REPEAT 1" only repeats only the track currently being played. Selecting "REPEAT" repeats all tracks.

DX-R700

REPEAT



RC-448C

REPEAT



To stop repeat playback

Repeatedly press the REPEAT button until "REPEAT" is no longer displayed.

Memo:

- You can press the REPEAT button during random playback to repeatedly playback all tracks in random order.
- You can press the REPEAT button during programmed playback to repeatedly playback the track currently being played or the track programmed.

Playing CDs

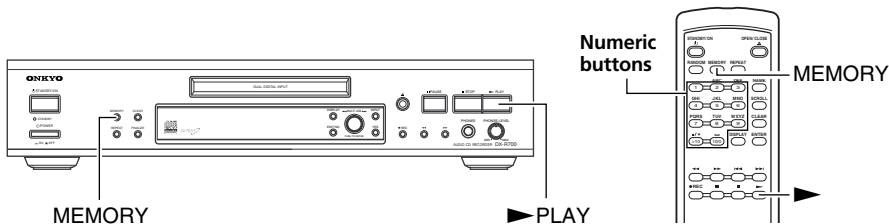

Programmed playback

Programmed playback allows you to select only the tracks that you want to play and in which order that you them to be played. Up to 25 tracks can be programmed at one time.

1 With playback stopped, press the MEMORY button.

The MEMORY indicator lights.

DX-R700



RC-448C



2 Press the numeric buttons for the tracks that you want to hear in the order that you want to hear them.

To select track numbers of 11 or greater (up to 99)

RC-448C: Press the [>10] button, then the numeric button corresponding to the 10's digit for the track number, and then the numeric button corresponding to the 1's digit.
Example: Track number 35: [>10] + [3] + [5]

To verify the programmed track numbers

Press the $\blacktriangleright\blacktriangleright/\blacktriangleleft\blacktriangleleft$ button.

Memo:

You can also turn the MULTI JOG dial to select tracks and press the dial to enter them.

3 Press the ▶ button.

Playback starts to the order programmed.

DX-R700

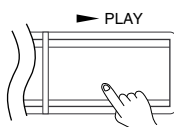

RC-448C



To stop programmed playback

Press the ■ button.

To stop the programmed playback mode

With playback stopped, press the MEMORY button.

To clear the programmed tracks

With playback stopped, press the CLEAR button. Each time a button is pressed, the last track is cleared.

Note:

The numeric buttons are disabled during programmed playback.

Further, the EDIT/NO button will not work when the MEMORY indicator lights.

Total time of the programmed tracks

Total time of the programmed tracks is displayed as "---m--s" when it exceeds 100 minutes.



Playing CDs

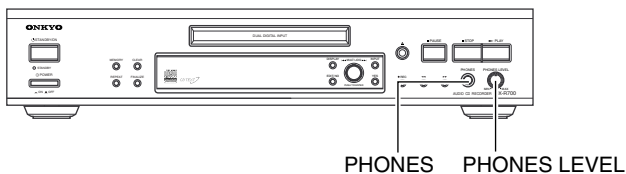

Listening with the headphones

- 1** Connect the stereo headphones mini plug to the PHONES jack.



Lower volume and then disconnect headphones.

- 2** Use the PHONES LEVEL dial to adjust the volume.



Other Information

Rules concerning digital recording

Guide to the serial copy management system

You cannot use digital recording to create a second-generation copy, a copy of a copy created through digital recording, with a CD-R or CD-RW. This is because the unit conforms to the Serial Copy Management System and permits only one generation of digital-to-digital copying (the recording of the original digital signals as they are). The Serial Copy Management System is based on the following three rules.

Principle 1

Digital-to-digital copying can be used to create a copy of a CompactDisc (CD), Digital Audio Tape (DAT), MiniDisk (MD), etc. with a CD-R or CD-RW. However, digital-to-digital copying is not allowed to create a copy of a CD-R or CD-RW that has been created through digital-to-digital copying.

Principle 2

Digital-to-digital copying can be used to create a copy of a CD-R or CD-RW that contains the songs

from analog records, FM radio programs, etc. you recorded using the unit. However, digital-to-digital copying is not allowed to create a copy of a CD-R or CD-RW that has been created through digital-to-digital copying. When two CD recorders are connected via the analog input and output terminals, however, recording can be performed beyond this restriction.

Principle 3

With a DAT deck or a CD recorder that supports the sampling frequencies of 32 kHz and 48 kHz, digital-to-digital copying can be used to record the digital sound from satellite broadcast. (This CD recorder supports these sampling frequencies.) In this case, digital-to-digital copying is allowed to create a second-generation copy. However, with some BS tuners, second-generation copy may not be produced.

- * When CD recorders are connected using analog terminals, the number of dubbings is not limited.

Display messages

Message	Explanation	Pages
Open	Disc tray is opening.	17
Welcome	Disc tray is closing.	17
Rec Setup	Setting initial settings for recording. Please wait.	25
TOC Reading	Reading the table of contents recorded on the disc. Please wait.	17
PMA Writing	Recording TOC data to the disc PMA (Program Memory Area). Never turn off the power while this message is displayed.	18
Erase Last?	Erasing the last track. To erase the last track, press the YES button or the MULTI JOG dial.	35
Erase All?	Erasing all tracks. To erase all track, press the YES button or the MULTI JOG dial.	35
TOC Erase?	Erasing the TOC from a finalized disc to return it to the unfinalized condition. To erase the TOC, press the YES button.	36
Ers: (* - *) ?	Erasing from track selected to last track. To erase, press the YES button or the MULTI JOG dial.	35
Initialize?	Erase all data from disc. To erase all data, press the YES button or the MULTI JOG dial.	37
Name In?	Asking if you are entering a disc name, artist name, and track names. To enter names, press the YES button (or the MULTI JOG dial).	28

If during operation a malfunction occurs or an improper operation is performed, the corresponding message will appear. For a description of these messages, refer to the explanations on the following pages.

Troubleshooting guide

If the DX-R700 begins to operate improperly, use the troubleshooting guide below to help you ascertain the problem.

Because the unit contains a microcomputer to provide advanced functions, it may malfunction due to external noise or static electricity. If this happens, disconnect the power cord and then plug it in again after about 5 seconds.

About the self-diagnosis function

The DX-R700 is equipped with a self-diagnosis function. If a malfunction is detected during operation, one of the messages given below will appear in the front display.

Display	Cause	Remedy
Disc Error	<ul style="list-style-type: none">• Playback was likely stopped due to dirt, dust, scratches, or vibrations.• The disc has been placed in upside down.	<ul style="list-style-type: none">• Eject the disc and check for dirt, dust, and scratches.• Eject the disc and check that it is placed in correctly. <p>If you place the disc correctly and the same message appears, unplug the power cord and plug it back in again. If the same message appears again, contact an Onkyo service representative.</p>
System Error (flashing)	A malfunction has occurred in the system due to excessive noise or static electricity.	Unplug the power cord and plug it back in again. If the same message appears again, contact an Onkyo service representative.

Messages during recording

Display	Cause	Remedy
Cannot Copy	The input digital signal contains a copy guard signal (SCMS).	Record an analog signal or recordable music signal (see page 18).
D. In Unlock	<ul style="list-style-type: none">• The digital input is blocked.• Data has been input in the CD-ROM, etc.	<ul style="list-style-type: none">• Verify that the player component is properly playing and the digital cable is properly connected (see page 15).• Verify that source signal is a normal music signal (see page 18).
Check Level	The player component was already playing.	Stop the player component. Shortly thereafter, "Signal Wait" will appear (see page 23).
Rec Setup	The DX-R700 is entering the recording standby state.	Wait until the message disappears.
Repair	After recording, the disc was left in the DX-R700 when the power was turned off and the track numbers and recording time data was lost.	While "Repair" is displayed, the DX-R700 is tracing back through the recorded area and repairing the track numbers and recording time data. When the message disappears, finalization of the disc is possible. Depending on the recording amount, this process may take up to 40 minutes.
Disc Full	Either the disc is full of recordings or 99 tracks have been recorded and no more recordings can be made on the disc.	Use a new disc.

Troubleshooting guide

Messages during recording (continued)

Display	Cause	Remedy
Pro Disc	A CD-R or a CD-RW not for music recording use (without the "FOR CONSUMER" marking) or a CD-RW has been inserted.	Eject the disc and check whether it meets the specifications for use with the DX-R700. Always insert a disc that has the markings "FOR CONSUMER" or "FOR MUSIC USE ONLY" on its surface (see page 12).
Check Input	Synchronous recording cannot be performed because the detected input signal is from a source other than the CD, MD, DAT, or DCC.	Record from a recordable source.
Cannot Rec	Recording cannot be performed because a finalized CD-R is used.	Replace it with a non-finalized CD-R.
	Recording cannot be performed because a finalized CD-RW is used.	Replace it with a non-finalized CD-RW. Or, retry recording after unfinalizing it.

Messages during playback, name input, and other situations

Display	Cause	Remedy
Blank Disc	You have tried to play a disc that has no recordings on it.	If the inserted disc is a CD-R or CD-RW with no recordings, you may record onto it, but it cannot be played.
No Disc	No disc has been inserted.	Open the disc tray and make sure that a disc is inserted.
Name Disc	Finalizing a disc without disc name was attempted.	Enter a disc name before attempting finalization (see pages 28, 33).
Name Full	Entering name information exceeding the limitation of 1000 characters per disc was attempted.	You can enter up to 1000 characters per disc (see page 28).
Full	Entering a name exceeding the limitation of 100 characters per name was attempted.	You can enter up to 100 characters per name (see page 28).
Erase Name	Name input cannot be performed because the unit retains name information for a previous disc.	Erase the name information retained in the unit. Or, write the retained name information to the previous disc and then enter name information to the new disc (see pages 28, 32).
A.Finalize	Name input cannot be performed during auto finalization.	Cancel auto finalization before performing name input (see pages 19, 23, 28).
Memory Full	Programming more than 25 tracks was attempted.	You can program up to 25 tracks.
Cannot Edit	Editing a finalized CD-RW was attempted.	Unfinalize the CD-RW before attempting disc edit (see page 36). This message also appears during random playback, memory playback, or other situations where disc editing is not possible or when an ineditible disc is used.

Troubleshooting guide

Messages during playback, name input, and other situations (continued)

Trouble	Cause	Remedy
The power does not turn on	The power cord is not properly plugged in.	Plug the power cord properly into a mains power supply.
	The component where the power cord is plugged into is not turned on.	Turn on the component into which the power cord is plugged.
No sound is output from the speakers	The speakers are not properly connected.	Connect the speakers following the procedure given in "Connecting the DX-R700" on page 15.
Cannot record	The components are not properly connected.	Connect the components following the procedure given in "Connecting the DX-R700" on page 15.
	A finalized CD-R or CD-RW is being used.	Use an unfinalized disc.
	The input switch is not properly set.	Switch to a properly connected input source (see pages 20, 22, 24).
	The recording level adjustment is set too low.	Adjust the recording level to a proper level (see page 21).
Recorded sound is distorted	The components are not properly connected.	Connect the components following the procedure given in "Connecting the DX-R700" on page 15.
	Recording is being affected by the television.	Either turn off the television or move the DX-R700 away from the television.
	The disc is damaged or cracked.	Use another disc.
	The recording level adjustment is set too high.	Adjust the recording level to a proper level (see page 21).
	The disc is too dirty.	Clean the disc.
Remote controller does not work	The remote controller batteries are dead.	Replace all the remote controller batteries with new batteries (see page 11).
	There is an object between the DX-R700 and the remote controller obstructing the signals.	Remove the obstructing object (see page 11).
	The remote controller is being used outside of its operational range.	Use the remote controller within its operational range (see page 11).
A recorded CD-R cannot be played in normal CD players	The disc was not finalized after recording. (The CD-R indicator lights when the disc is played with the DX-R700)	Perform the finalization process (see page 33).

Specifications

System	Compact disc recorder
Recording/playing time	Max. 80 min (Approx., when using an 80-min disc)
D/A converter	Advanced Multi bit
Digital filter	8 times oversampling
Connections	1 analog output, 1 analog input 2 digital input (optical/coaxial), 2 digital output (optical/coaxial)
Frequency response	5 Hz to 20 kHz
Playback total harmonic distortion	0.004 % (1 kHz)
Playback dynamic range	98 dB
Playback signal-to-noise ratio	98 dB
Recording total harmonic distortion	0.006 % (1 kHz)
Recording dynamic range	92 dB
Recording signal-to-noise ratio	94 dB
Channel separation	90 dB (during playback)
Wow and flutter	Below threshold of measurability
Output level	2.0 V r.m.s. (analog)
Power supply	AC230-240 V, 50 Hz (European models) AC120/220-230 V switchable, 50/60 Hz (Worldwide models)
Power consumption	12 W
Standby	2.8 W (Worldwide models) 2.9 W (European models)
External dimensions	435 (W) x 91 (H) x 314 (D) mm (17-1/8" x 3-9/16" x 12-3/8")
Weight	4.2 kg (9.3 lbs.)

Specifications and features are subject to change without notice.

Memo

ONKYO CORPORATION

Sales & Product Planning Div. : 2-1, Nisshin-cho, Neyagawa-shi, OSAKA 572-8540, JAPAN
Tel: 072-831-8111 Fax: 072-833-5222 <http://www.onkyo-intl.com>

ONKYO U.S.A. CORPORATION

18 Park Way, Upper Saddle River, N.J. 07458, U.S.A.
Tel: 201-785-2600 Fax: 201-785-2650 <http://www.onkyousa.com>

ONKYO EUROPE ELECTRONICS GmbH

Liegnitzerstrasse 6, 82194 Groebenzell, GERMANY
Tel: +49-8142-4401-0 Fax: +49-8142-4401-555 <http://www.onkyo.net>

ONKYO CHINA LIMITED

Units 2102-2107, Metroplaza Tower I, 223 Hing Fong Road, Kwai Chung,
N.T., HONG KONG Tel: 852-2429-3118 Fax: 852-2428-9039

