

ONKYO®

Speaker System

D-407C

Instruction Manual

Thank you for your purchase of the Onkyo speaker system.

Please read this manual thoroughly before using it.

Following the instructions in this manual will enable you to obtain optimum performance and listening enjoyment from your new speaker system.

Please retain this manual for future reference.

使用手冊

謝謝閣下購買 Onkyo 的揚聲器系統。

在連接各部件及接通電源之前，請先徹底閱讀本手冊。

遵從本手冊內的各項指示，使您的揚聲器系統能夠獲得最優秀的性能和欣賞效果，您將能獲得最大樂趣。

請保存此手冊以備將來參考之用。

Before using this unit En-2
使用本系統之前 Ct-2

Precaution on use En-2
使用注意事項 Ct-2

Connection En-2
連接 Ct-2

Placement En-3
安放 Ct-3

**Attaching and detaching
the speaker grilles** En-3
揚聲器前格板的安裝和拆除 Ct-3

Use with a TV set En-3
作為電視機的外接揚聲器
使用時 Ct-3

Speaker care En-3
揚聲器的維護保養 Ct-3

Specifications En-4
規格 Ct-4

Before using this unit

- The speaker cabinet is made of wood and is therefore sensitive to extreme temperatures and humidity. Avoid placing the speaker systems in locations subjected to direct sunlight, or in smoky or in humid places, such as near an air conditioner, humidifier, bathroom, or kitchen. Doing so may result in damage to the speaker.
- Place the unit on a rigid, level surface. Placing it on a slanted surface or weak base not only may cause the unit to fall, but also results in decreased sound quality.
- Be sure to turn off your amplifier before connecting the speaker system. Connecting them with the amplifier's power on may result in damage to the amplifier or the speaker system.
- Keep water or other liquids away from the unit. If water is spilled into the unit, not only the unit but also the speakers themselves may be damaged.

Precaution on use

- This speaker system can handle the specified input power when it is used for ordinary music reproduction. If the following abnormal signals are fed to the speaker, however, an overcurrent may flow in the internal circuits, causing burning or breakage of the wires even if the input power is below the specified rating.
 1. Noise produced when FM station is not tuned in
 2. Sound produced when fast-forwarding cassette tape deck
 3. High-frequency sound generated by an oscillator, an electronic musical instruments, etc.
 4. Oscillating amplifier signals
 5. Special test signals produced by audio checking CD, etc.
 6. Sound produced when connecting or disconnecting audio connection cables (Always turn off the amplifier's power before connecting or disconnecting cables.)
 7. Howling when a microphone is used
- Do not place magnetic objects such as screwdrivers and iron parts near the tweeter since they use speakers with strong magnets. Otherwise, the objects may be attracted, causing injury or damaging the diaphragm.

Connection

- Turn the sound volume to the minimum and disconnect the power cord from the amplifier before connecting the speaker cables.
- The nominal impedance of this speaker system is $6\ \Omega$. Use only amplifiers capable of handling this impedance.
- Use the supplied speaker cables to connect between speaker's input terminals and the amplifier's speaker terminals as illustrated below.
- Connect the speaker cables securely to the terminals, with the core wires twisted properly. In this case, make sure that the core wires do not touch each other. Note that a short circuit in core wires may result in damage to the amplifier.

Connecting to AV amplifier

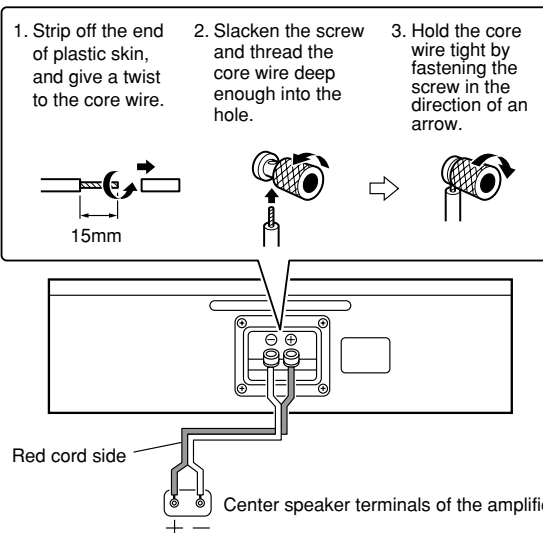

Before turning on the amplifier's power switch:

- Make sure that the positive (+) and negative (-) speaker cables do not contact each other. Otherwise, a short-circuit may occur, causing damage to the amplifier.
- Be sure to connect the speaker cables with correct polarity (connect the speaker's positive (+) and negative (-) binding posts with the amplifier's corresponding speaker terminals). Reversed polarity results in impaired bass-range reproduction, causing mislocalization of the sound image. Also, be sure to connect the Right and Left speakers with the amplifier's corresponding speaker terminals.
- Pull lightly on the speaker cables to ensure that they are connected firmly.



Placement

For better-quality sound, observe the following precautions when you install the speaker system:

- Placing the speaker system on several small-diameter supports generally results in better sound than placing it directly on a wide installation surface. Also note that high quality bass cannot be obtained if the speaker system is unstably positioned. Always use the cork spacers or thin metal discs (such as coins) to seat the speaker stably.

D-407C Center Speaker

Place the D-407C as close as possible to your television set, for example, above or below the television set. Be sure to set the D-407C firmly on the television set or other equipment so that it cannot slip and fall. This is especially important if you have small children. If the D-407C is to be placed on a television set, be sure that:

- The supporting area of the TV is larger than that of the D-407C.
- The TV's support surface is flat and level.
- The TV is not placed on an unstable support.

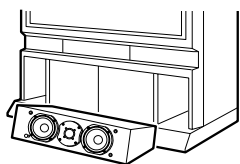

Attach the circular cork pieces as slip stopper onto the bottom surface of the speaker. And you can secure the cabinet to the wall, etc. by using a durable cord with cup hooks: Find a hole on the either side of backside the speaker, and screw into each hole the cup hook of about 4 mm in diameter and 15 mm long, and then secure the speaker to the wall, etc. with the cord. Place the speaker with the sloping side up, unlike in the case when placed in lower location.

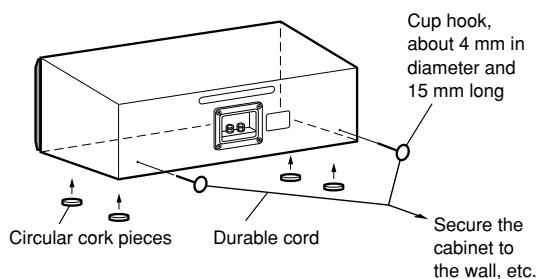

Attaching and detaching the speaker grilles

This speaker system uses detachable grilles. Use the following method to attach or detach the grilles.

1. While holding the left (or right) side edge of the speaker grille with your both hands, pull it gently toward you to remove the bottom of the grille.
2. In the same way, gently pull the right (or left) side edge of the speaker grille toward you to remove it from the main unit.
3. To replace the grill, push the projections at the corners into the grille plug holes on the speaker cabinet.

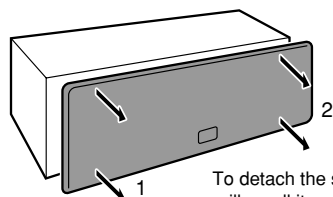

To detach the speaker grille, pull it gently at the left and right side edge.

D-407C

Use with a TV set

In general, Braun tubes used for color television sets, etc. are extremely sensitive and can be affected even by the magnetism of the earth. If a speaker system is used near them, therefore, discoloration or distortion of pictures will occur. To allow use with color television sets, etc., this speaker system is provided with magnetic shielding.

Even so, discoloration may still result, depending on the installation environment. If discoloration occurs, turn off the power of the television set, wait for 15 to 30 minutes and then turn it on again. This activates the self-demagnetizing function of the television set, improving the display condition. If discoloration persists even after performing this remedy, move the speaker apart from the television set. Discoloration may also be caused when a magnet or other magnetizing object exists near the television because of the combined effect.

Speaker care

Your Onkyo speakers are finished with a high quality covering that serves to protect the wood speaker cabinet. Wipe the cabinet periodically with a dry, silicon-embedded or plain soft cloth.

The covering may be cleaned with a soft cloth moistened with water and a mild soap. Avoid the use of furniture polishes or harsh cleansers. Use a soft brush or hand vacuum cleaner to remove dust and lint from the grille material.

Natural wood finished cabinets

The cabinets are finished with a natural wood surface. They have a unique wood grain pattern. Your cabinets have their own raw beauty and uniqueness which is unlocked from the tree; this is depicted by the cross-grain patterns with dark and light coloring. You can enjoy Onkyo's craftsmanship not only when designing for the best sound quality, but to assimilate natural blessings for the visual senses. The paint and finishing work of the cabinets are conducted under the strictest quality control standards.

Specifications

Type:	2-way bass reflex
Impedance:	6 Ω
Maximum input power:	180 W
Output sound pressure level:	86.5 dB/W/m
Frequency response:	58 Hz - 40 kHz
Crossover frequency:	3000 Hz
Cabinet capacity:	6.1 L
Speaker (woofer):	13 cm A-OMF cone x 2
Speaker (tweeter):	2.5 cm soft dome
Dimensions:	500 (W) x 146 (H) x 168 (D) mm (Overall dimensions)
Weight:	6.3 kg
Others:	Magnetic shielding
Accessory:	2.5 m speaker cable x 1 Cork spacer x 4 Instruction manual

Specifications and appearance are subject to change for improvement without prior notice.

In catalogs and on packaging, the letter added to the end of the product name indicates the color of the D-407C. Specifications and operation are the same regardless of color.



使用本系統之前

- 本揚聲器的箱體是木質的，因此，對極高(或極低)的溫度和溼度非常敏感。請不要將揚聲器系統放置在陽光直射之處，或多煙塵和高濕氣的地方，如靠近空調機、加濕器或浴室、廚房中。否則，將會損壞揚聲器。
- 請將系統放置在牢固的水平表面上。若將其放置在斜面上或放置不穩，則不僅會有揚聲器系統跌落的危險，還會降低其音質。
- 在連接揚聲器系統之前，請務必先關閉您的AV接收機。若在AV接收機電源打開的狀況下進行連接，則可能會損壞AV接收機或揚聲器系統。
- 請注意不要讓水或其它液體濺入本系統。如果有水濺入本系統，本系統和揚聲器都有可能受到損壞。

使用注意事項

- 當本揚聲器系統被用來進行普通的音樂再生時，可以承受一定的輸入功率。但如果下述異常信號被輸入揚聲器，即使其輸入功率低於最大輸入功率，也有可能內部電路中產生過大的電流，使線路燒毀或損壞。
 1. 當收聽調頻廣播未調准電台時產生的噪音
 2. 當盒式錄音帶快進時產生的聲音
 3. 由振蕩器、電聲樂器等產生的高頻音響
 4. 振蕩的AV接收機信號
 5. 由音頻測試CD等產生的特殊測試信號
 6. 在連接或拆除音頻纜線時產生的聲音(請務必在連接或拆除纜線前關閉AV接收機的電源)。
 7. 使用麥克風時的反饋嘯聲
- 請勿將螺絲刀等磁性物體和鐵制物品放置在揚聲器系統附近，因為牠們會通過強磁場影響揚聲器系統，或者，牠們可能會被磁性吸至揚聲器上，導致振動膜的損傷或徹底損壞。

連接

- 在連接揚聲器纜線之前，請先將AV接收器音量調至最小，並關閉AV接收機電源開關(Power)。
- 本揚聲器系統的額定阻抗是6Ω。請只使用對應於此阻抗的AV接收機。
- 如下圖所示，使用隨機附帶的揚聲器纜線，連接揚聲器的接線柱和AV接收機的揚聲器端子。
- 連接揚聲器纜線時，請正確地纏繞芯線，將其牢固地連接在端子上。這時，請確認芯線沒有相互接觸。請注意，芯線間的短路會導致AV接收機的損壞。

連接到AV接收機

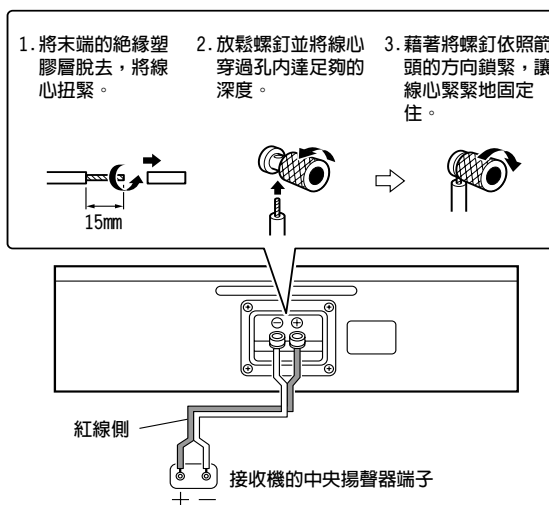

在打開AV接收機的電源開關之前：

- 確認揚聲器纜線的正極(+)和負極(-)沒有相互接觸。否則可能會發生短路，導致AV接收機的損壞。
- 在連接揚聲器纜線時，一定要保證極性的正確。(將揚聲器的正(+)和負(-)接線柱連接至AV接收機上相應的揚聲器端子。) 極性接反將會妨害低音的再生，併導致聲場不能正確定位。同時，請務必使左側和右側的兩個揚聲器與AV接收機上相應的揚聲器端子正確地連接。
- 輕拉揚聲器纜線，以確認其已牢固地連接。



安放

為了獲得最佳的音質，在安裝揚聲器系統時請遵守下列注意事項：

- 一般而言，與直接安放在平坦表面上相比，將揚聲器系統安放在幾個支腳上能獲得更佳的音質。另外請注意，如果揚聲器系統安放不穩，將不能得到高質量的低音。請使用隨機軟木間隔墊或薄金屬片(如硬幣)將揚聲器墊穩。

D-407C 中央揚聲器

安放D-407C揚聲器時，應盡可能將其靠近您的電視機，例如，放在電視機之上或電視機之下。安放在電視機或其它部件之上時，請確保D-407C安放穩固，不會滑動或跌落。這在您家中有小孩時尤其重要。如果您要將D-407C安放在電視機上，請務必保證：

- 電視機支持面的面積要比D-407C的底面積大。
- 電視機的支持面必須為水平的。
- 電視機被穩固地安放。

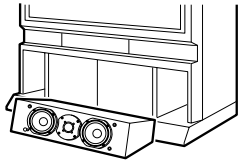

將圓形的軟木塞片當作阻滑片連接至揚聲器的底面。您可以使用帶有杯掛鉤的堅固繩索將櫃子固定於牆上及其他東西之上：在揚聲器背面的任一側找出一個孔，將直徑約 4 mm，長約 15 mm的杯掛鉤鎖入每一個孔內，然後使用繩索將揚聲器固定至牆壁或其他東西之上。安置揚聲器使其傾斜面向上（不同於將其安置於較低位置時的擺放方式）

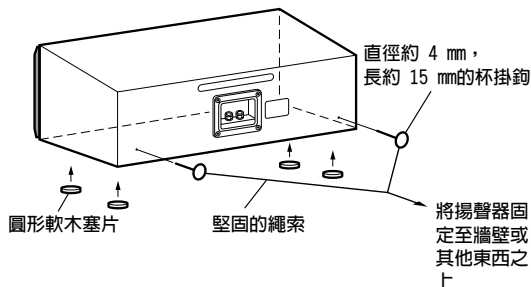

揚聲器前格板的安裝和拆除

本揚聲器系統使用可拆式前格板。安裝和拆除的方法如下。

- 用兩手抓住揚聲器前格板的左(或右)邊，輕輕向外拉，將前格板的下部拆開。
- 用同樣的方法，輕輕向外拉前格板的右(或左)邊，將前格板從箱體上拆下。
- 安裝前格板時，將突起部推入揚聲器箱體的前格板安裝插孔。

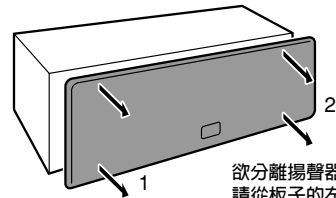

欲分離揚聲器前格板時，請從板子的左、右邊緣輕輕地拉開。

D-407C

作為電視機的外接揚聲器使用時

通常，應用於彩色電視機等的陰極射線管是極為敏感的，牠們甚至會受到地球磁場的影響。如果揚聲器系統靠近牠們，則會產生色調混亂或圖像失真。為了能夠和彩色電視機等同時使用，本揚聲器系統進行了磁場屏蔽，將磁場限制於箱體內。

但是，即使進行了屏蔽，根據安裝的環境，也有可能發生色調混亂。如果出現色調混亂，請關閉電視機的電源，等待15至30分鐘，然後再次打開電視機電源。這將啟動電視機的自動消磁功能，改善顯示狀況。如果在進行這種補救措施後仍有色調混亂，請將揚聲器離開電視機遠一些。由於綜合影響，當一塊磁鐵或其它磁性物體放置在電視機附近時，也有可能出現色調混亂現象。

揚聲器的維護保養

您的Onkyo揚聲器表面覆蓋了高質量的膜，以保護木質的箱體。

請定期用一塊硅夾層軟布或普通軟布擦拭機體。

其表面可以用軟布蘸清水來擦拭，可以使用刺激性不強的肥皂。請不要使用家具拋光劑或去污粉。

請用軟刷或手持型吸塵器去除沾在前格板上的灰塵和絨毛。

天然原木表面的櫃子

本櫃子的表面係使用天然原木作成的。這種表面有特殊的木質晶格的花樣。讓您的櫃子富有樹木所具有的原始美麗的色澤和特色；這些特點則藉著其深淺顏色的交叉晶格的花樣表現出來。您不但可以享受 Onkyo 所設計出的最優良的音質，也帶給您融入大自然造化的視覺享受。櫃子的油漆和表面處理是在嚴格的品質控制之下進行的。

規格

型式：	雙路低音反射
阻抗：	6 Ω
最大輸入功率：	180 W
輸出聲壓電平：	86.5 dB/W/m
頻率響應：	58 Hz-40 kHz
交叉頻率：	3000 Hz
箱體容積：	6.1 L
低音揚聲器：	13 cm A-OMF 錐型揚聲器×2
高音揚聲器：	2.5 cm 軟質半球型體
尺寸：	500(寬)×146(高)×168(深) mm (包括揚聲器前格板)
重量：	6.3 kg
其它：	磁場屏蔽
附件：	2.5 m 揚聲器纜線×1 軟木間隔墊(cork spacer)×4 使用手冊(本書)

規格和外觀如有變更，恕不另行通知。

在目錄和包裝上，產品標號最後的字母表示D-407C的顏色。雖然顏色不同，但是操作和規格都是一樣的。

ONKYO CORPORATION

Sales & Product Planning Div. : 2-1, Nisshin-cho, Neyagawa-shi, OSAKA 572-8540, JAPAN
Tel: 072-831-8023 Fax: 072-831-8124

ONKYO U.S.A. CORPORATION

18 Park Way, Upper Saddle River, N.J. 07458, U.S.A.
Tel: 201-785-2600 Fax: 201-785-2650 <http://www.onkyousa.com>

ONKYO EUROPE ELECTRONICS GmbH

Liegnitzerstrasse 6, 82194 Groebenzell, GERMANY
Tel: +49-8142-4401-0 Fax: +49-8142-4401-555 <http://www.onkyo.net>

ONKYO EUROPE UK Office

Suite 1, Gregories Court, Gregories Road, Beaconsfield, Buckinghamshire, HP9 1HQ
UNITED KINGDOM Tel: +44-(0)1494-681515 Fax: +44(0)-1494-680452

ONKYO CHINA LIMITED

Units 2102-2107, Metroplaza Tower I, 223 Hing Fong Road, Kwai Chung,
N.T., HONG KONG Tel: 852-2429-3118 Fax: 852-2428-9039



D0408-1

SN 29343897

(C) Copyright 2004 ONKYO CORPORATION Japan. All rights reserved.



* 2 9 3 4 3 8 9 7 *