

ONKYO®

AV Receiver

TX-DS484

Instruction Manual

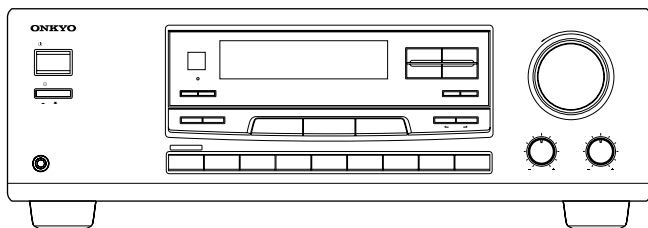

Thank you for purchasing the Onkyo AV Receiver. Please read this manual thoroughly before making connections and turning on the power. Following the instructions in this manual will enable you to obtain optimum performance and listening enjoyment from your new AV Receiver. Please retain this manual for future reference.

Contents

Before using

Important Safeguards.....	2
Precautions	3
Features.....	4
Supplied accessories.....	4
Before operating this unit	5

Preparation

Audio equipment connections	6
Video equipment connections	7
Connecting other devices	8
Connecting speakers.....	10
Positioning speakers.....	11
Connecting the power.....	11
Making antenna connections	12

Operation

Speaker setup.....	14
Selecting a sound source	17
To enjoy Surround mode or Stereo mode	20
Tuning in a radio station.....	23
Using preset radio stations.....	24
Recording a source	25

Appendix

Troubleshooting guide.....	27
Specifications	28

Control guide

Control positions and names	29
Remote controller RC-427S	30
Using the remote controller	31

WARNING:

TO REDUCE THE RISK OF FIRE OR ELECTRIC SHOCK, DO NOT EXPOSE THIS APPLIANCE TO RAIN OR MOISTURE.

CAUTION:

TO REDUCE THE RISK OF ELECTRIC SHOCK, DO NOT REMOVE COVER (OR BACK). NO USER-SERVICEABLE PARTS INSIDE. REFER SERVICING TO QUALIFIED SERVICE PERSONNEL.



WARNING
RISK OF ELECTRIC SHOCK
DO NOT OPEN

AVIS
RISQUE DE CHOC ELECTRIQUE
NE PAS OUVRIR



The lightning flash with arrowhead symbol, within an equilateral triangle, is intended to alert the user to the presence of uninsulated "dangerous voltage" within the product's enclosure that may be of sufficient magnitude to constitute a risk of electric shock to persons.



The exclamation point within an equilateral triangle is intended to alert the user to the presence of important operating and maintenance (servicing) instructions in the literature accompanying the appliance.

Important Safeguards

- Read Instructions** – All the safety and operating instructions should be read before the appliance is operated.
- Retain Instructions** – The safety and operating instructions should be retained for future reference.
- Heed Warnings** – All warnings on the appliance and in the operating instructions should be adhered to.
- Follow Instructions** – All operating and use instructions should be followed.
- Cleaning** – Unplug the appliance from the wall outlet before cleaning. The appliance should be cleaned only as recommended by the manufacturer.
- Attachments** – Do not use attachments not recommended by the appliance manufacturer as they may cause hazards.
- Water and Moisture** – Do not use the appliance near water –for example, near a bath tub, wash bowl, kitchen sink, or laundry tub; in a wet basement; or near a swimming pool; and the like.
- Accessories** – Do not place the appliance on an unstable cart, stand, tripod, bracket, or table. The appliance may fall, causing serious injury to a child or adult, and serious damage to the appliance. Use only with a cart, stand, tripod, bracket, or table recommended by the manufacturer, or sold with the appliance. Any mounting of the appliance should follow the manufacturer's instructions, and should use a mounting accessory recommended by the manufacturer.
- An appliance and cart combination should be moved with care. Quick stops, excessive force, and uneven surfaces may cause the appliance and cart combination to overturn.
- Ventilation** – Slots and openings in the cabinet are provided for ventilation and to ensure reliable operation of the appliance and to protect it from overheating, and these openings must not be blocked or covered. The openings should never be blocked by placing the appliance on a bed, sofa, rug, or other similar surface. The appliance should not be placed in a built-in installation such as a bookcase or rack unless proper ventilation is provided. There should be free space of at least 20 cm (8 in.) and an opening behind the appliance.
- Power Sources** – The appliance should be operated only from the type of power source indicated on the marking label. If you are not sure of the type of power supply to your home, consult your appliance dealer or local power company.
- Grounding or Polarization** – The appliance may be equipped with a polarized alternating current line plug (a plug having one blade wider than the other). This plug will fit into the power outlet only one way. This is a safety feature. If you are unable to insert the plug fully into the outlet, try reversing the plug. If the plug should still fail to fit, contact your electrician to replace your obsolete outlet. Do not defeat the safety purpose of the polarized plug.
- Power-Cord Protection** – Power-supply cords should be routed so that they are not likely to be walked on or pinched by items placed upon or against them, paying particular attention to cords at plugs, convenience receptacles, and the point where they exit from the appliance.
- Outdoor Antenna Grounding** – If an outside antenna or cable system is connected to the appliance, be sure the antenna or cable system is grounded so as to provide some protection against voltage surges and built-up static charges. Article 810 of the National Electrical Code, ANSI/NFPA 70, provides information with regard to proper grounding of the mast and supporting structure, grounding of the lead-in wire to an antenna-discharge unit, size of grounding conductors, location of antenna-discharge unit, connection to grounding electrodes, and requirements for the grounding electrode. See Figure 1.
- Lightning** – For added protection for the appliance during a lightning storm, or when it is left unattended and unused for long periods of time, unplug it from the wall outlet and disconnect the antenna or cable system. This will prevent damage to the appliance due to lightning and power-line surges.
- Power Lines** – An outside antenna system should not be located in the vicinity of overhead power lines or other electric light or power circuits, or where it can fall into such power lines or circuits. When installing an outside antenna system, extreme care should be taken to keep from touching such power lines or circuits as contact with them might be fatal.
- Overloading** – Do not overload wall outlets, extension cords, or integral convenience receptacles as this can result in a risk of fire or electric shock.
- Object and Liquid Entry** – Never push objects of any kind into the appliance through openings as they may touch dangerous voltage points or short-out parts that could result in a fire or electric shock. Never spill liquid of any kind on the appliance.
- Servicing** – Do not attempt to service the appliance yourself as opening or removing covers may expose you to dangerous voltage or other hazards. Refer all servicing to qualified service personnel.
- Damage Requiring Service** – Unplug the appliance from the wall outlet and refer servicing to qualified service personnel under the following conditions:
 - When the power-supply cord or plug is damaged,
 - If liquid has been spilled, or objects have fallen into the appliance,
 - If the appliance has been exposed to rain or water,
 - If the appliance does not operate normally by following the operating instructions. Adjust only those controls that are covered by the operating instructions as an improper adjustment of other controls may result in damage and will often require extensive work by a qualified technician to restore the appliance to its normal operation,
 - If the appliance has been dropped or damaged in any way, and
 - When the appliance exhibits a distinct change in performance – this indicates a need for service.

PORTABLE CART WARNING



S3125A

21. **Replacement Parts** – When replacement parts are required, be sure the service technician has used replacement parts specified by the manufacturer or have the same characteristics as the original part. Unauthorized substitutions may result in fire, electric shock, or other hazards.
22. **Safety Check** – Upon completion of any service or repairs to the appliance, ask the service technician to perform safety checks to determine that the appliance is in proper operation condition.
23. **Wall or Ceiling Mounting** – The appliance should be mounted to a wall or ceiling only as recommended by the manufacturer.
24. **Heat** – The appliance should be situated away from heat sources such as radiators, heat registers, stoves, or other appliances (including amplifiers) that produce heat.

Precautions

1. Warranty Claim

You can find the serial number on the rear panel of this unit. In case of warranty claim, please report this number.

2. Recording Copyright

Recording of copyrighted material for other than personal use is illegal without permission of the copyright holder.

3. AC Fuse

The fuse is located inside the chassis and is not user-serviceable. If power does not come on, contact your Onkyo authorized service station.

4. Care

From time to time you should wipe the front and rear panels and the cabinet with a soft cloth. For heavier dirt, dampen a soft cloth in a weak solution of mild detergent and water, wring it out dry, and wipe off the dirt. Following this, dry immediately with a clean cloth. Do not use rough material, thinners, alcohol or other chemical solvents or cloths since these could damage the finish or remove the panel lettering.

5. Power

WARNING

BEFORE PLUGGING IN THE UNIT FOR THE FIRST TIME, READ THE FOLLOWING SECTION CAREFULLY.

The voltage of the available power supply differs according to country or region. Be sure that the power supply voltage of the area where this unit will be used meets the required voltage (e.g., AC 230 V, 50 Hz or AC 120 V, 60 Hz) written on the rear panel.

Worldwide models are equipped with a voltage selector to conform to local power supplies. Be sure to set this switch to match the voltage of the power supply in your area before plugging in the unit.

For British model

Replacement and mounting of an AC plug on the power supply cord of this unit should be performed only by qualified service personnel.

IMPORTANT

The wires in the mains lead are coloured in accordance with the following code:

Blue : Neutral

Brown : Live

As the colours of the wires in the mains lead of this apparatus may not correspond with the coloured markings identifying the terminals in your plug, proceed as follows:

The wire which is coloured blue must be connected to the terminal which is marked with the letter N or coloured black.

The wire which is coloured brown must be connected to the terminal which is marked with the letter L or coloured red.

IMPORTANT

A 5 amp fuse is fitted in this plug. Should the fuse need to be replaced, please ensure that the replacement fuse has a rating of 5 amps and that it is approved by ASTA or BSI to BS1362. Check for the ASTA mark or the BSI mark on the body of the fuse.

IF THE FITTED MOULDED PLUG IS UNSUITABLE FOR THE SOCKET OUTLET IN YOUR HOME THEN THE FUSE SHOULD BE REMOVED AND THE PLUG CUT OFF AND DISPOSED OF SAFELY. THERE IS A DANGER OF SEVERE ELECTRICAL SHOCK IF THE CUT OFF PLUG IS INSERTED INTO ANY 13 AMP SOCKET.

If in any doubt, please consult a qualified electrician.

FIGURE 1:
EXAMPLE OF ANTENNA GROUNDING AS PER NATIONAL ELECTRICAL CODE, ANSI/NFPA 70

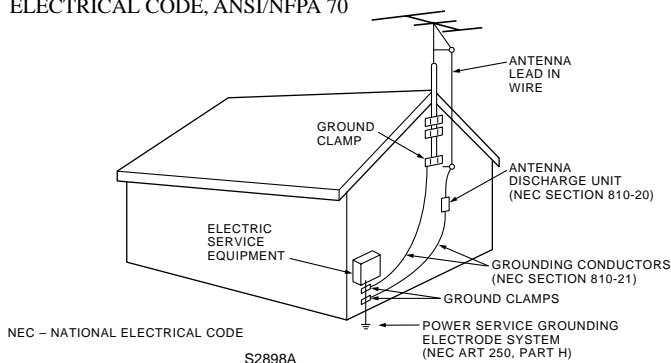

For U.S. model

Note to CATV system installer:

This reminder is provided to call the CATV system installer's attention to Article 820-40 of the NEC, ANSI/NFPA 70, which provides guidelines for proper grounding and, in particular, specifies that the cable ground shall be connected to the grounding system of the building, as close to the point of cable entry as practical.

FCC Information for User

CAUTION:

The user changes or modifications not expressly approved by the party responsible for compliance could void the user's authority to operate the equipment.

NOTE:

This equipment has been tested and found to comply with the limits for a Class B digital device, pursuant to Part 15 of the FCC Rules. These limits are designed to provide reasonable protection against harmful interference in a residential installation. This equipment generates, uses and can radiate radio frequency energy and, if not installed and used in accordance with the instructions, may cause harmful interference to radio communications. However, there is no guarantee that interference will not occur in a particular installation. If this equipment does cause harmful interference to radio or television reception, which can be determined by turning the equipment off and on, the user is encouraged to try to correct the interference by one or more of the following measures:

- Reorient or relocate the receiving antenna.
- Increase the separation between the equipment and receiver.
- Connect the equipment into an outlet on a circuit different from that to which the receiver is connected.
- Consult the dealer or an experienced radio/TV technician for help.

For Canadian model

CAUTION: THIS DIGITAL APPARATUS DOES NOT EXCEED THE CLASS B LIMITS FOR RADIO NOISE EMISSION FROM DIGITAL APPARATUS SET OUT IN THE RADIO INTERFERENCE REGULATIONS OF THE CANADIAN DEPARTMENT OF COMMUNICATIONS.

For models having a power cord with a polarized plug:

CAUTION: TO PREVENT ELECTRIC SHOCK, MATCH WIDE BLADE OF PLUG TO WIDE SLOT, FULLY INSERT.

Modele pour les Canadien

ATTENTION: L'INTERFÉRENCE RADIO ÉLECTRIQUE GÉNÉRÉE PAR CET APPAREIL NUMÉRIQUE DE TYPE B NE DÉPASSE PAS LES LIMITES ÉNONCÉES DANS LE RÈGLEMENT SUR LES PERTURBATIONS RADIO ÉLECTRIQUES, SECTION APPAREIL NUMÉRIQUE, DU MINISTÈRE DES COMMUNICATIONS.

Sur les modèles dont la fiche est polarisée:

ATTENTION: POUR ÉVITER LES CHOCS ÉLECTRIQUES, INTRODUIRE LA LAME LA PLUS LARGE DE LA FICHE DANS LA BORNE CORRESPONDANTE DE LA PRISE ET POUSSER JUSQU'AU FOND.

Features

- 55 W/CH TO EACH OF THE FIVE CHANNELS INTO 8 OHMS, 20 Hz—20 kHz, 0.08% THD (North American models, FTC rating)
- 75 W/CH TO EACH OF THE FIVE CHANNELS INTO 6 OHMS, 1 kHz, DIN (European models, DIN)
- 100 W/CH TO EACH OF THE FIVE CHANNELS INTO 6 OHMS, 1 kHz, EIAJ (Asian models, EIAJ)
- WIDE RANGE AMPLIFIER TECHNOLOGY (WRAT)
- 6-OHM, HIGH CURRENT, LOW-IMPEDANCE DRIVE FOR ALL 5 CHANNELS
- DISCRETE OUTPUT STAGE AMPS FOR ALL 5 CHANNELS
- 2 HIGH QUALITY EXTRUDED HEAT SINKS
- OVERSIZED POWER TRANSFORMER
- LARGE, HIGH-QUALITY CAPACITORS
- A/B SPEAKER SELECTION
- DTS* AND DOLBY** DIGITAL DECODER ONBOARD
- DUAL BANANA-PLUG COMPATIBLE TERMINALS FOR ALL CHANNELS
- 96-kHz/24-BIT DAC
- 5.1 MULTICHANNEL INPUTS
- 6 DSP SOUNDFIELDS
- 3 ASSIGNABLE DIGITAL INPUTS (2 COAXIAL & 1 OPTICAL)
- LATE NIGHT MODE
- PRECISION SPEED-SENSITIVE DIGITAL VOLUME CONTROL
- ABSOLUTE VOLUME DISPLAY
- 30 FM/AM RANDOM PRESETS
- ALUMINUM FRONT PANEL
- FULL-FUNCTION REMOTE

*Manufactured under license from Digital Theater Systems, Inc. US Pat. No.5,451,942 and other worldwide patents issues and pending. "DTS" and "DTS Digital Surround" are trademarks of Digital Theater Systems, Inc.© 1996 Digital Theater Systems, Inc. All rights reserved.

**Manufactured under license from Dolby Laboratories. "Dolby", "Pro Logic" and the double-D symbol  are trademarks of Dolby Laboratories. Confidential Unpublished Works. ©1992-1997 Dolby Laboratories, Inc. All rights reserved.

Supplied accessories

Check that the following accessories are supplied with this unit.

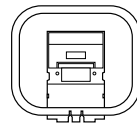

AM loop antenna × 1



FM indoor antenna × 1

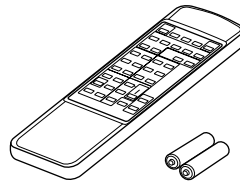

Remote controller (RC-427S) × 1
Batteries (size AA or UM-3) × 2

The following accessories are only available for worldwide models.

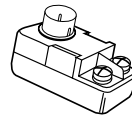

75/300 ohm antenna adapter × 1

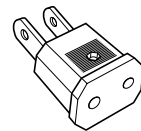

Conversion plug (Shape may vary depending on the area which it was purchased.) × 1

Memory Preservation

This unit does not require memory preservation batteries. A built-in memory power back-up system preserves the contents of the memory during power failures and even when the unit is unplugged. The unit must be plugged in order to charge the back-up system.

The memory preservation period after the unit has been unplugged varies depending on climate and placement of the unit. On the average, memory contents are protected over a period of a few weeks after the last time the unit has been unplugged. This period is shorter when the unit is exposed to a highly humid climate.

Declaration of Conformity

We, ONKYO EUROPE
ELECTRONICS GmbH
INDUSTRIESTRASSE 20
82110 GERMERING,
GERMANY



declare in own responsibility, that the ONKYO product described in this instruction manual is in compliance with the corresponding technical standards such as EN60065, EN55013, EN55020 and EN61000-3-2, -3-3 (or EN60555-2, -3).

GERMERING, GERMANY

K. OTSU

ONKYO EUROPE ELECTRONICS GmbH

Before operating this unit

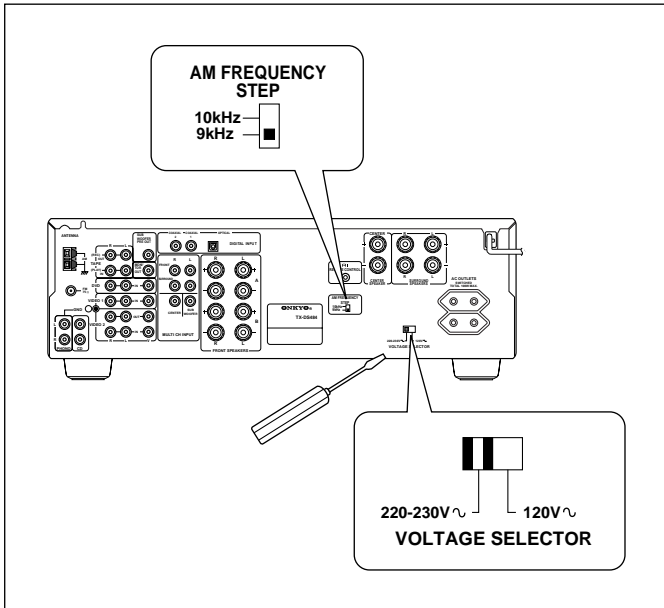

Setting the AM tuning step frequency (Worldwide models only)

Worldwide models are equipped with a switch that controls the AM band tuning steps. Please set this switch to match the AM band tuning step frequency in your area.

- U.S.A. and Canada : 10 kHz
- Other areas : 9 kHz

Setting the Voltage selector (Worldwide models only)

Worldwide models are equipped with a voltage selector to conform with local power supplies. Be sure to set this switch to match the voltage of the power supply in your area before plugging in the unit.

1. Determine the proper voltage for your area: 220-230 V or 120 V.
2. If the preset voltage is not correct for your area, insert a screwdriver into the groove in the switch. Slide the switch all the way to the right (120 V) or to the left (220-230 V), whichever is appropriate.

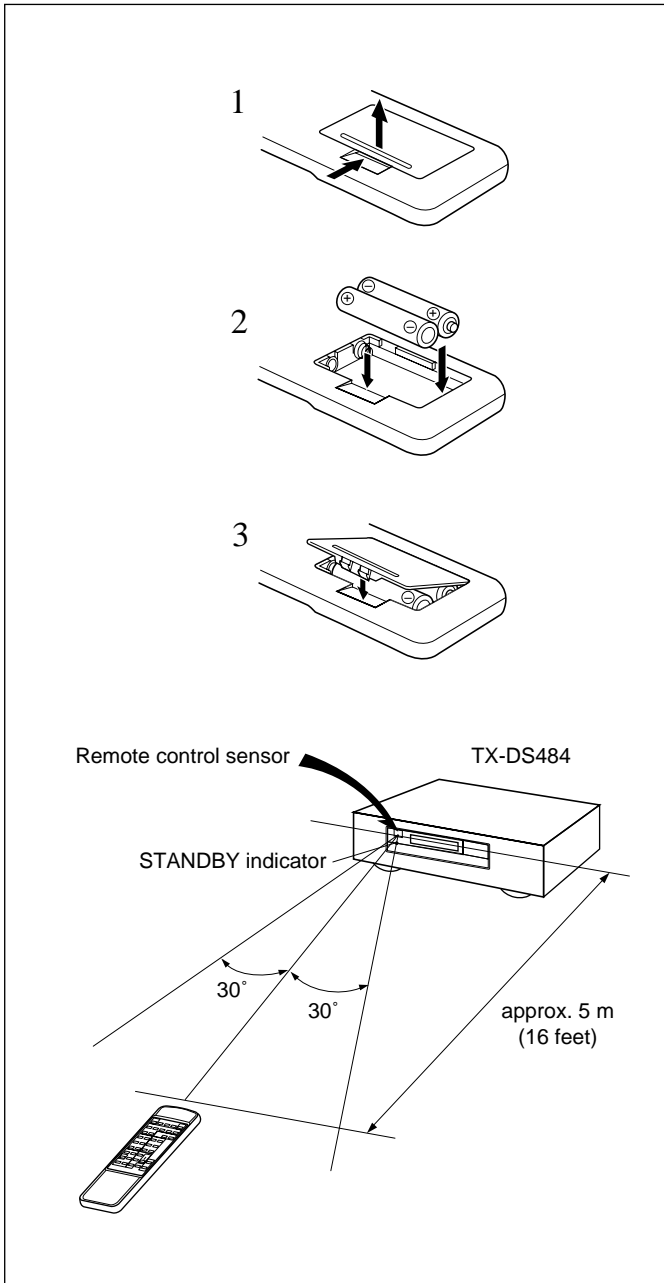

Installing the remote controller batteries

1. Remove the battery compartment cover by pressing the tab and lifting up the cover.
2. Insert two AA (R6- or UM-3-) size batteries into the battery compartment. Carefully follow the polarity diagram (positive (+) and negative (-) symbols) inside the battery compartment.
3. After batteries are installed and seated correctly, replace the compartment cover.

Notes

- Do not mix new batteries with old batteries or different kinds of batteries.
- To avoid corrosion, remove the batteries if the remote controller is not to be used for a long time.
- Remove dead batteries immediately to avoid damage from corrosion. If the remote controller doesn't operate smoothly, replace both the batteries at the same time.
- The life of the batteries supplied is about six months but this will vary depending on usage.

Using the remote controller

Point the remote controller toward the remote control sensor. The STANDBY indicator lights up when the unit receives a signal from the remote controller.

Notes

- Place the unit away from strong light such as direct sunlight or inverted fluorescent light which can prevent proper operation of the remote controller.
- Using another remote controller of the same type in the same room or using the unit near equipment which uses infrared rays may cause operational interference.
- Do not put any object such as a book on the remote controller. The buttons of the remote controller may be pressed by mistake and drain the batteries.
- Make sure the audio rack doors do not have colored glass. Placing the unit behind such doors may prevent proper remote controller operation.
- If there is any obstacle between the remote controller and the remote control sensor, the remote controller will not operate.

Video equipment connections

- On each pair of input jacks, a red connector (marked R) corresponds to the right channel, and a white connector (marked L) to the left channel.
- A yellow connector (marked V) is used for video connection.
- Please refer to the instruction manual of each component when making any connections.

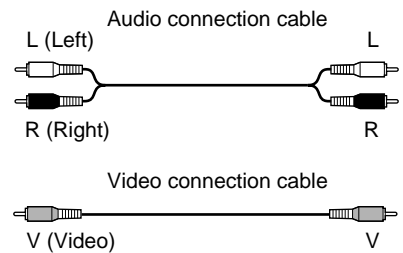

Digital audio connections

This receiver has a powerful digital signal processor for use with DVD players, DAT decks, MD player, and CD players. The digital inputs, COAXIAL 1, 2 and OPTICAL can be assigned to individual input selector buttons, so when an input selector button is pressed, the assigned digital input is used instead of the corresponding analog input. (See page 19.)

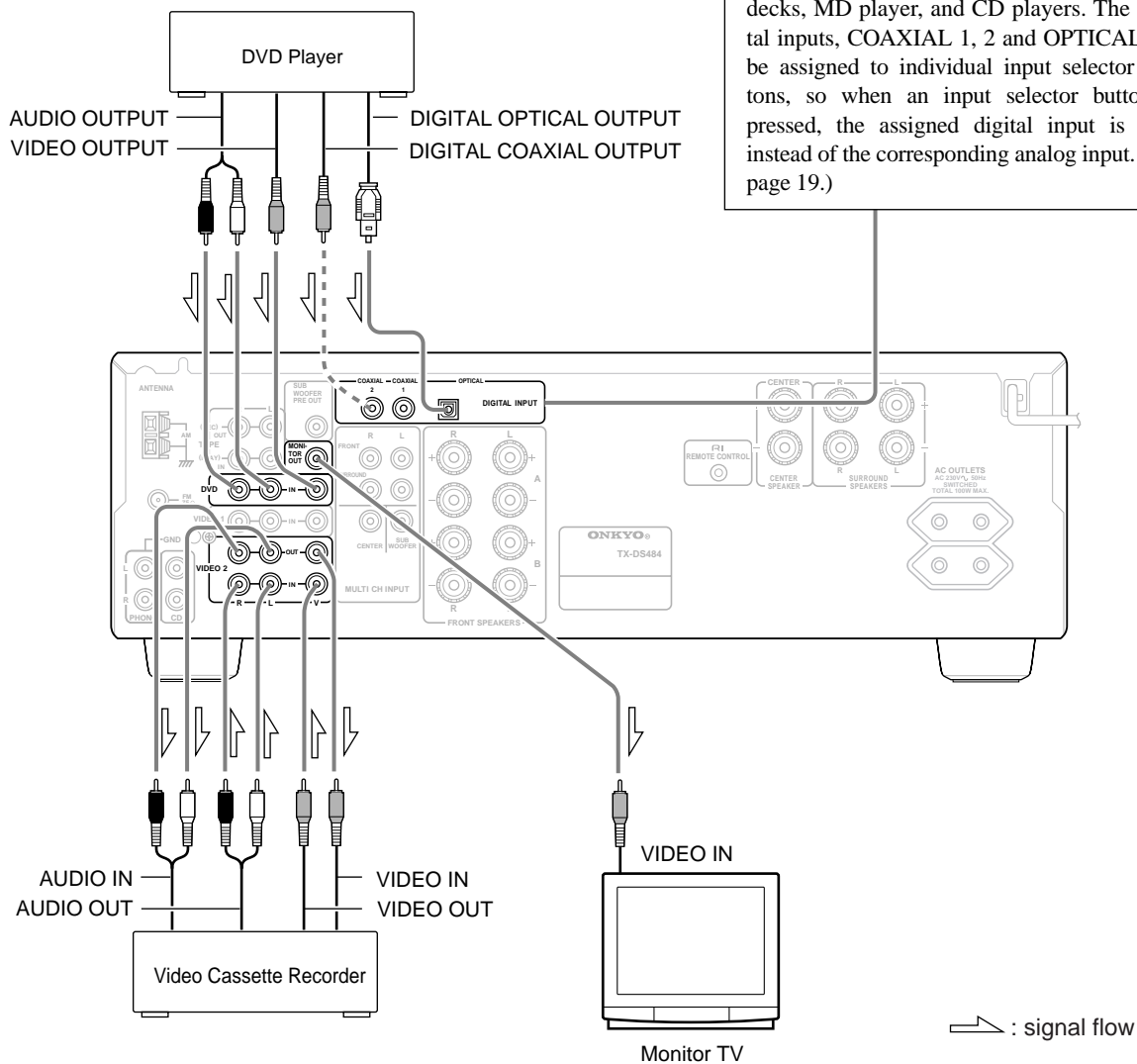

Notes:

- When using a playback-only VCR, you need to make only the output connections.
- This receiver can be used with only a monitor TV equipped with a video input jack.
- Interference may be caused between the TV and this receiver. If this interference occurs, place the receiver and the TV as far apart as possible. We do not recommend the use of a common TV/FM antenna (see antenna section).
- A DVD or other component equipped with a digital output can be connected to this receiver. The digital connection must be used in conjunction with an analog connection, because if the analog cable is disconnected, the audio output from TAPE OUT and VIDEO 2 will not work.
- Remove the protective cap attached to the DIGITAL INPUT OPTICAL jack before making the connection. When this jack is not used, replace the protective cap.

Connecting other devices

- On each pair of input jacks, a red connector (marked R) corresponds to the right channel, and a white connector (marked L) to the left channel.
- A yellow connector (marked V) is used for video connection.
- Please refer to the instruction manual of each component when making any connections.

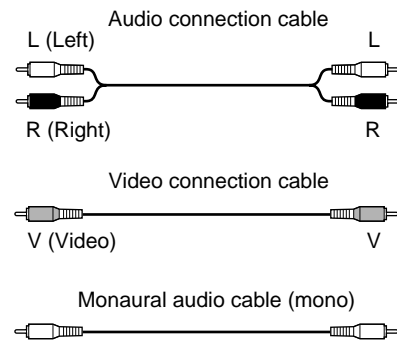

Decoder with 5.1 channel output

You may connect the 5.1 channel outputs of an external decoder (such as MPEG decoder) to the MULTI CH INPUTs of this unit. Use the DVD player or decoder controls to adjust the speaker settings for multi-channel input.

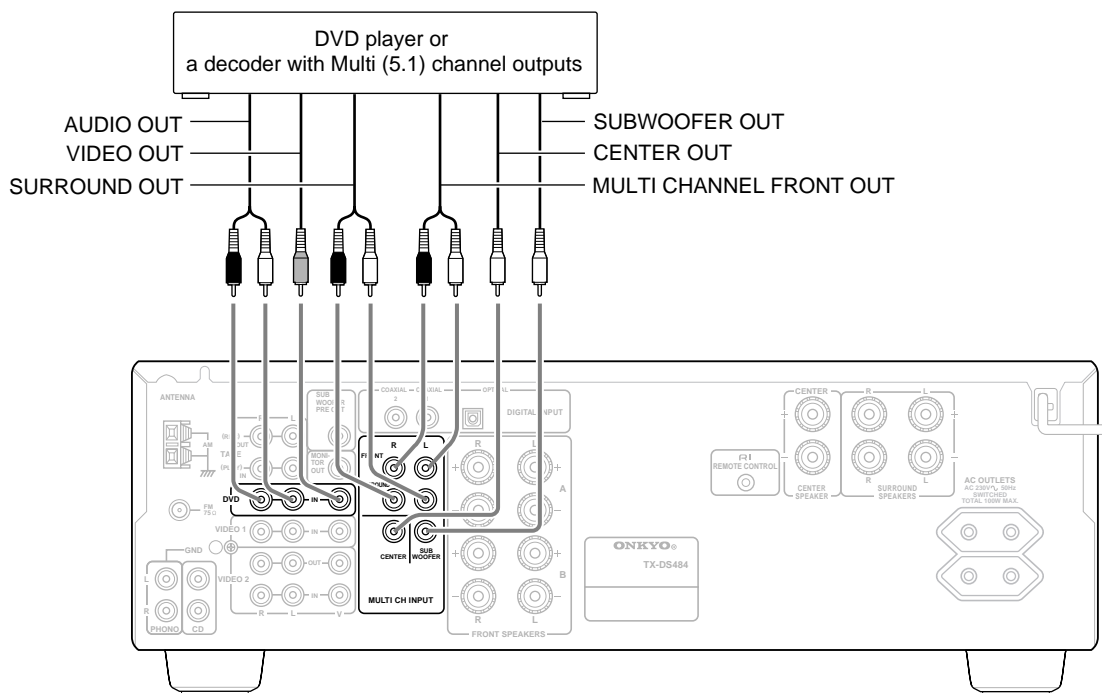

Connecting other devices

Worldwide and European models
Capacity is total 100 watts.

U.S.A. and Canadian models
Capacity is total 120 watts.

AC outlet connection

You can connect the power cord from another audio device to the rear of this receiver.

Since the AC outlets on the unit are a SWITCHED type outlet, you can use the STANDBY/ON button, or the POWER button on the remote controller to turn on/off the power to both this receiver and the connected audio devices.

First turn the POWER switch ON (ON).

The shape, number, and total capacity of the AC outlets may differ depending on the area of purchase. Make sure that the total capacity of other components connected to this unit does not exceed the capacity that is printed on the rear panel.

TX-DS484

CD Player

Cassette Tape Deck

DVD Player

Connections for remote control (RI)

You can use the remote controller of this receiver to operate cassette tape decks, compact disc players and DVD players that have Onkyo **RI** connectors.

Connect a remote control cable to the connector with the **RI** mark.

- An **RI** remote control cable equipped with a 3.5mm (1/8 in.)-diameter miniature two-conductor phone plug comes with every compact disc player, cassette tape deck, or DVD player that has an **RI** connector.
- Remote control operation is not possible if only the remote control cable is connected – the audio connection cables must also be connected.
- This receiver's remote controller does not support control of Onkyo turntables.
- If the connecting device has two **RI** connectors lined-up vertically or horizontally, you can use either of them. They both offer the same functionality.

Connecting speakers

- If you want to use the surround effects, connect surround speakers. For the best results, connect a center speaker.
- Use FRONT SPEAKERS B terminals to connect a second pair of front speakers.
- This receiver is designed to produce optimum sound quality when speakers with impedances within the specified ranges are connected. Please check the following information and choose speakers with appropriate impedances for the connections.

FRONT SPEAKERS: A or B: 6 ohms min./speaker
SURROUND SPEAKERS: 6 ohms min./speaker
CENTER SPEAKER: 6 ohms min.

Connecting the speaker cable

1. Twist wire ends very tight.

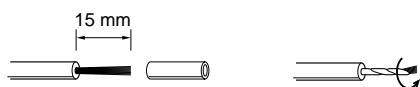

NOTE:

To prevent damage to circuitry, never short-circuit the positive (+) and negative (-) speaker wire.

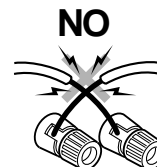

2. Unscrew.

3. Insert the wire.

4. Screw.

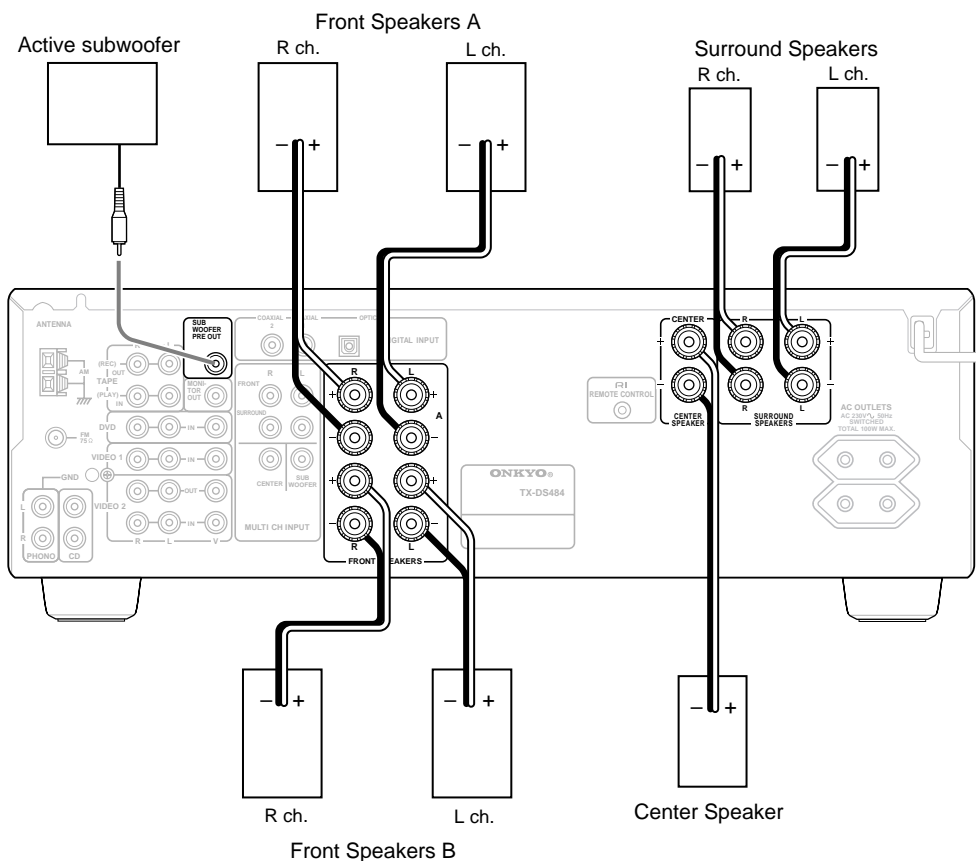
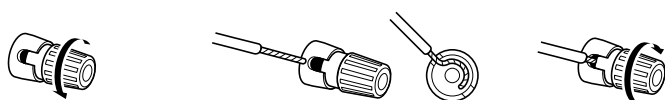

- When you use only one speaker or wish to listen to monaural (mono) sound, a single speaker should never be connected in parallel to both the right and left channel terminals simultaneously.

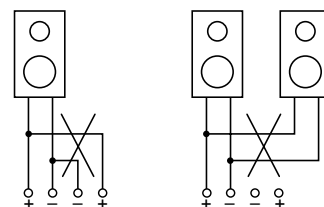

Positioning speakers

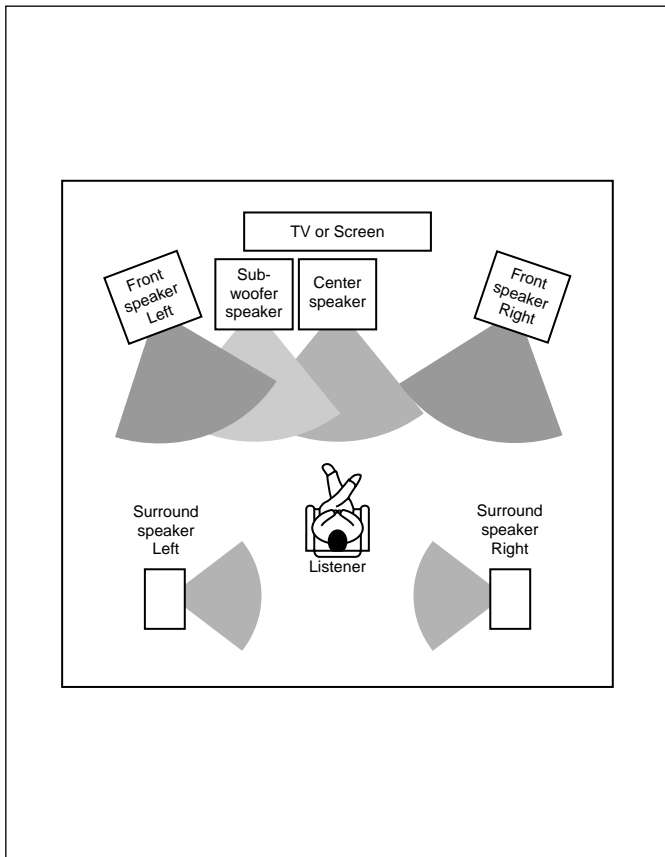

Positioning speakers

Speaker placement plays an important role in the reproduction of Surround sound. The placement of the speakers varies depending on the size of the room and the wall coverings used in the room. The illustration shows an example of a layout for standard speaker placement. Refer to this example when you position the speakers in order to experience the best of Surround sound.

Standard speaker placement

For ideal Surround effects, all speakers should be installed. If a center speaker or subwoofer is not connected, the sound from the unused channel is properly distributed to the connected speakers in order to produce the best Surround sound possible.

Front: The left, right, and center speakers should face the seated listener and be placed at ear level. The center speaker produces a richer sound image by enhancing the perception of the sound's source and movement.

Surround: Place the left and right Surround speakers 1 meter (3 feet) above the listener's ear level and facing toward the sides of the room, making sure that the listener is within the speakers' dispersion angle. These speakers produce the feel of a moving sound while creating the sensation of being in the middle of the action.

Subwoofer: Install a subwoofer with a built-in power amplifier for powerful bass sounds. The placement of the subwoofer does not affect the final quality of the sound image too much, so you can install it with the room layout in mind.

Refer to the speaker's instruction manual for more details.

Connecting the power

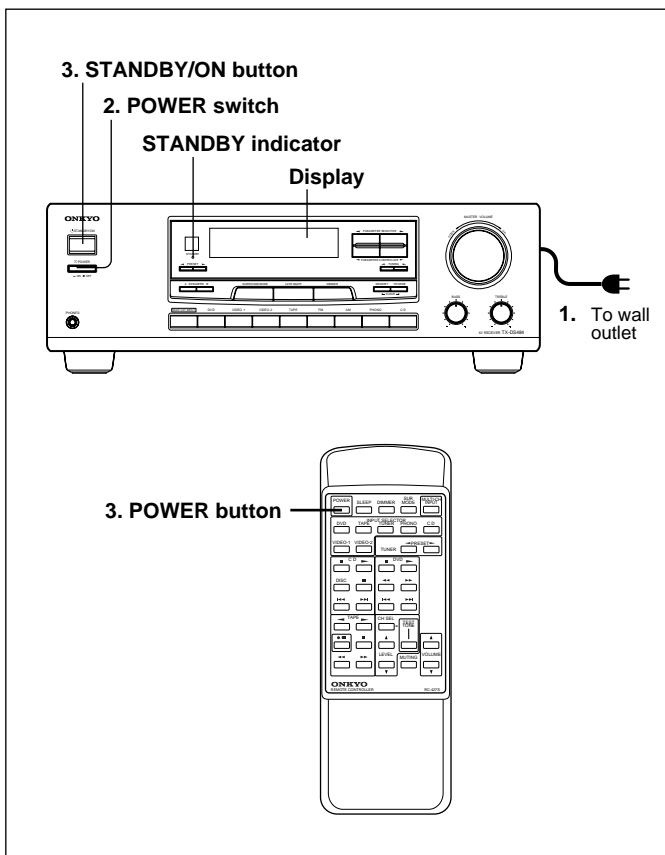

Connecting the power

- Before you plug in the receiver, confirm that all connections have been made properly.
- Turning on this receiver's power may cause a momentary power surge, which might interfere with other electrical equipment, such as computers. If this happens, use a wall outlet on a different circuit.

1. Plug the power cord into an AC wall outlet.

NOTE:

When you use the TX-DS484 for the first time:

When the TX-DS484 is shipped from the factory, the POWER switch is set to ON (). Therefore, when you plug in the power cord to the AC outlet, the Standby indicator lights up and the unit enters Standby mode as described in Step 2.

2. Press the POWER switch to set it to the ON () position to place the receiver in Standby mode.

The STANDBY indicator will light up.

Press the POWER switch again to set it to the OFF () position to turn off the power to the receiver.

3. Press the STANDBY/ON button or POWER button on the remote controller to turn on the receiver. The display will light up and the STANDBY indicator will be turned off.

If you press the STANDBY/ON button or POWER button on the remote controller again, the receiver returns to Standby mode.

- You cannot use the remote controller if the POWER switch on the receiver is set to OFF.

Making antenna connections

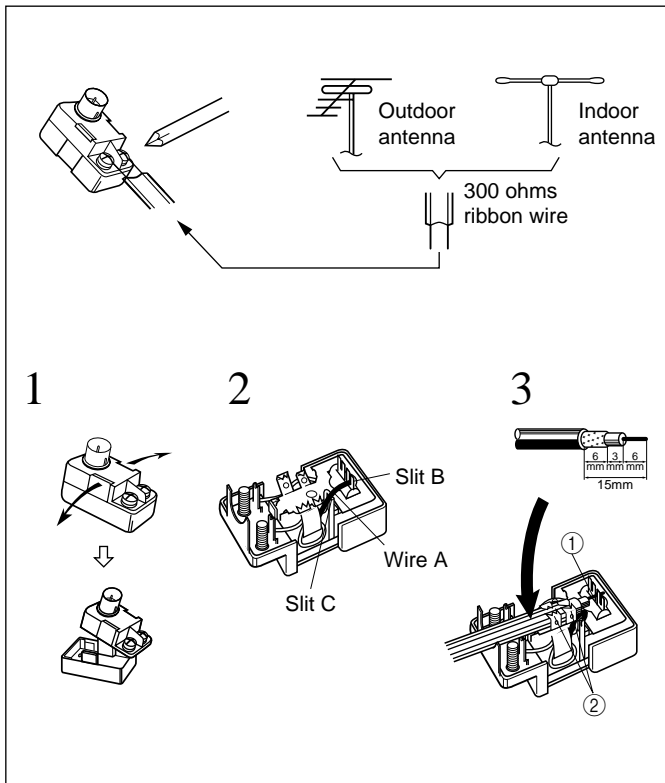

Connecting the antenna cable to the 75/300 ohm antenna adapter (Worldwide models)

Connecting the 300 ohm ribbon wire:

Loosen the screws and wrap the wire around these screws. Then tighten the screws with a screwdriver.

Connecting the coaxial cable:

1. With your fingernail or a small screwdriver, press the stoppers outward and remove the cover.
2. Remove the transformer wire A from slit B and insert it into slit C.
3. Prepare the coaxial cable as shown in the diagram. Connect the 75/300 ohm antenna adapter to the coaxial cable.
 - ① Insert the end of the cable.
 - ② Clamp it in place with pliers.
4. Re-install the cover.

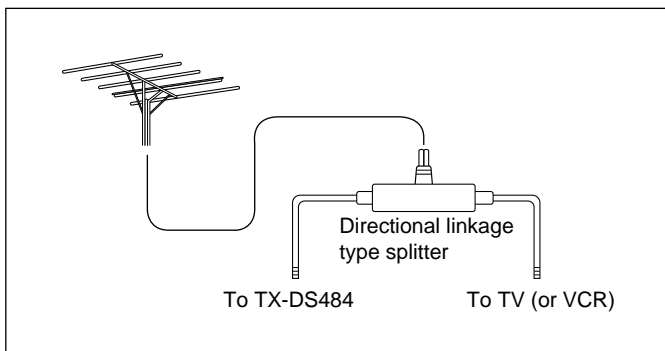

Directional linkage

Do not use the same antenna for both FM and TV (or VCR) reception since the FM and TV (or VCR) signals can interfere with each other. If you must use a common FM/TV (or VCR) antenna, use a directional linkage type splitter.

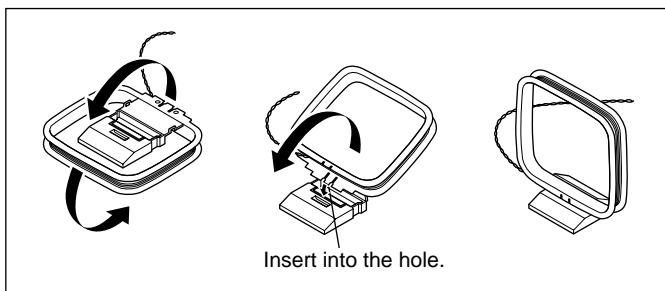

Assembling the AM loop antenna

Assemble the loop antenna as shown in the illustration.

- Refer to the next page for details on connecting the AM loop antenna.

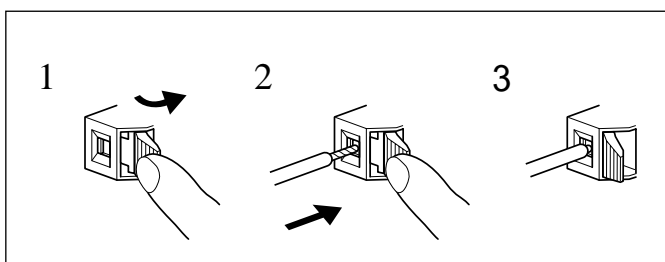

Connecting the antenna cable

1. Press down the lever.
2. Insert the wire into the hole.
3. Release the lever to replace it.

Making antenna connections

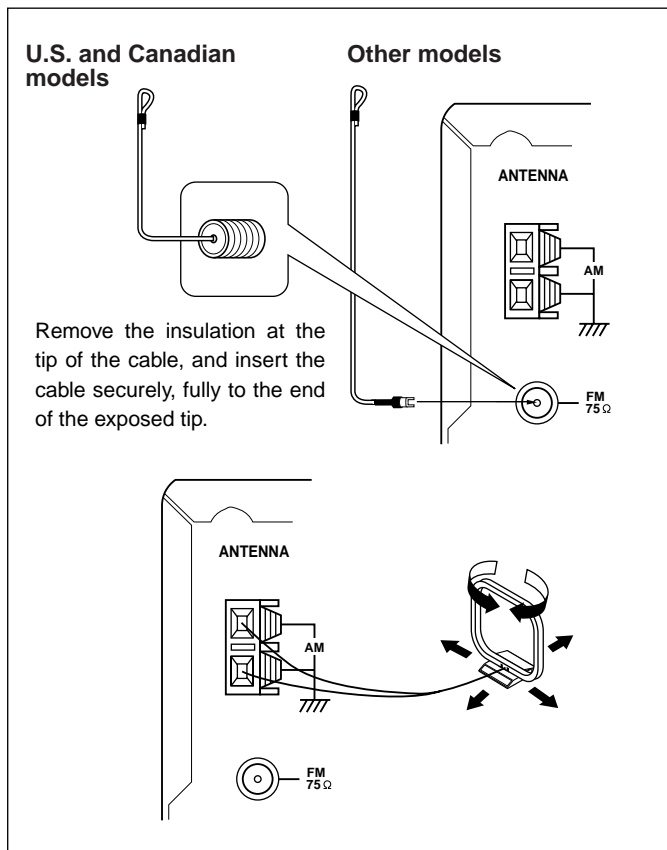

Connecting the included antennas

Connecting the FM indoor antenna:

The FM indoor antenna is for indoor use only. Extend the antenna and move it in various directions until the clearest signal is received. Fix it with push pins or similar implements in the position that will cause the least amount of distortion.

If the reception is not very clear with the attached FM indoor antenna, the use of an outdoor antenna is recommended.

Connecting the AM loop antenna:

The AM loop antenna is for indoor use only. Set it in the direction and position where you receive the clearest sound. Put it as far away as possible from the unit, TVs, speaker cables, and power cords.

When reception is not satisfactory with the attached AM loop antenna alone, connection of an outdoor antenna is recommended.

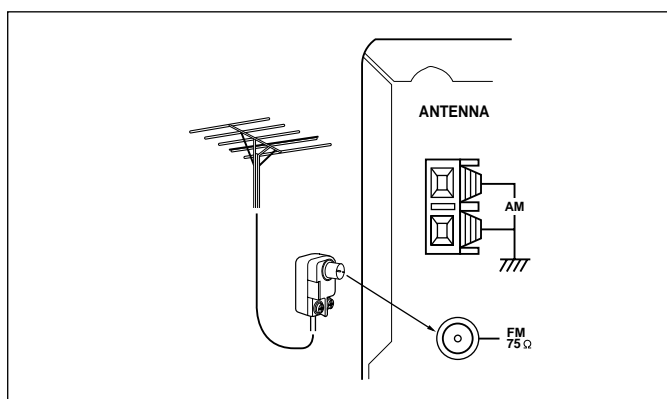

Connecting an FM outdoor antenna

Please make sure that you follow the considerations below regarding the location.

Keep the antenna away from noise sources (neon signs, busy roads, etc.).

It is dangerous to put the antenna close to power lines. Keep it well away from power lines, transformers, etc.

- To avoid the risk of lightning and electrical shock, grounding is necessary. Follow item 14 of the "Important Safeguards" on page 2 when you install the outdoor antenna.

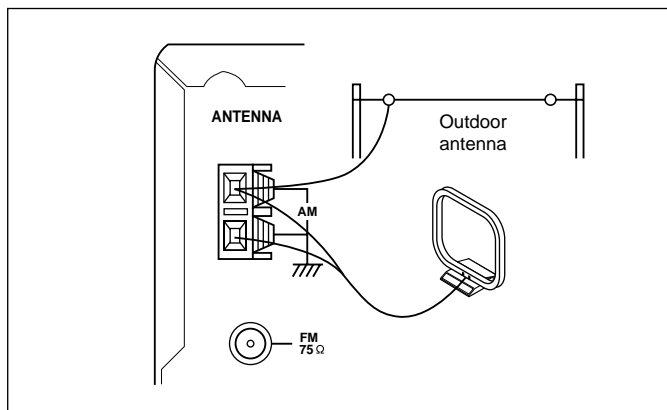

Connecting an AM outdoor antenna

The outdoor antenna will be more effective if it is stretched horizontally above a window or outside.

- Do not remove the AM loop antenna.
- To avoid the risk of lightning and electrical shock, grounding is necessary. Follow item 14 of the "Important Safeguards" on page 2 when you install the outdoor antenna.

Speaker setup

PARAMETER SELECTOR/ PARAMETER CONTROLLER buttons

Use these buttons to set the speaker parameters, such as the type and distance.

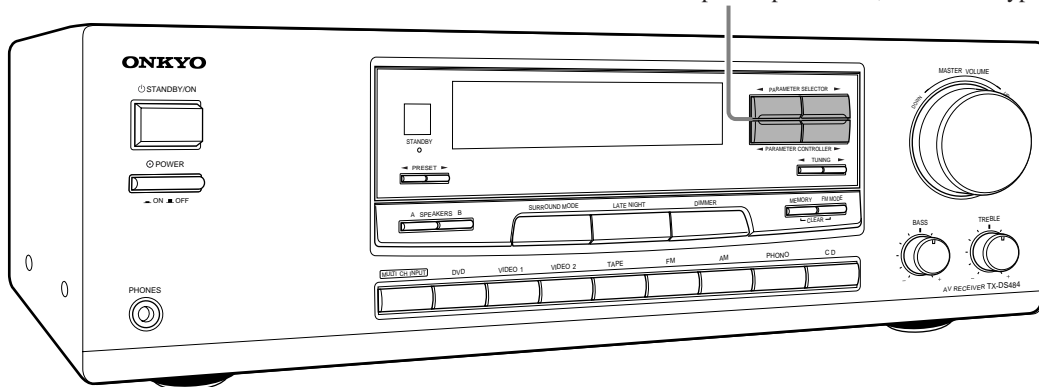

LEVEL ▲/▼ buttons

Use these buttons to adjust the level of each speaker.

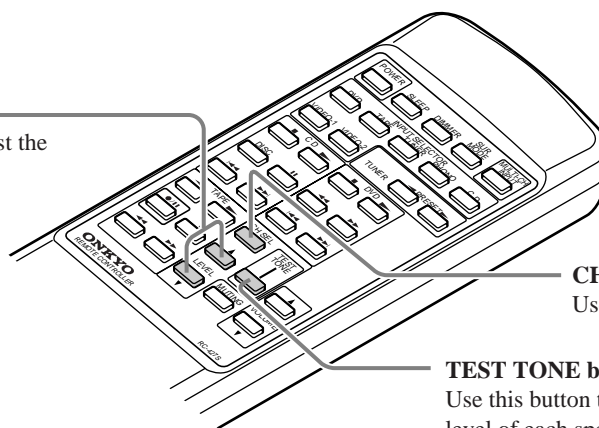

CH SEL button

Use this button to select a speaker.

TEST TONE button

Use this button to adjust the level of each speaker.

1	
2	<p style="text-align: center;">SUBWOOFER= YES</p> <p style="text-align: center;">or</p> <p style="text-align: center;">SUBWOOFER= NO</p>
3	<p style="text-align: center;">FRONT = LARGE</p> <p style="text-align: center;">or</p> <p style="text-align: center;">FRONT = SMALL</p>

Speaker setup

Before operating your stereo system, you need to set the type and position of the connected speakers.

1. Press the **PARAMETER SELECTOR** button once to display the subwoofer parameter.
2. Press the **PARAMETER CONTROLLER** buttons to select "YES" if a subwoofer is connected, or select "NO" if a subwoofer is not connected.
3. Press the **PARAMETER SELECTOR** button to display the front speaker size parameter, and press the **PARAMETER CONTROLLER** buttons to select "LARGE" or "SMALL" according to the speaker size.
 LARGE: Select this for large, wideband speakers.
 SMALL: Select this for small speakers with limited bass signal handling.

- If you have selected "NO" for the subwoofer in step 2, you can select only "LARGE" for the front speakers.

Speaker setup

4		<p>CENTER =LARGE</p> <p>or</p> <p>CENTER =SMALL</p> <p>or</p> <p>CENTER =NONE</p>
5		<p>SURROUND =LARGE</p> <p>or</p> <p>SURROUND =SMALL</p> <p>or</p> <p>SURROUND =NONE</p>
6		<p>FRONT =3.6m / 12"</p> <p>meter feet</p> <p>FRONT =3.9m / 13"</p>
7		<p>CENTER =3.6m / 12"</p> <p>or</p> <p>CENTER =3.9m / 13"</p>
8		<p>SURR =2.1m / 7"</p> <p>or</p> <p>SURR =2.4m / 8"</p>

- Press the **PARAMETER SELECTOR** ► button to display the center speaker size parameter, and press the **PARAMETER CONTROLLER** ◀/► buttons to select "LARGE", "SMALL" and "NONE."

Note:

If you have selected "SMALL" for the front speakers, you can select only "SMALL" or "NONE" for the center speaker.

LARGE: When a large speaker is used as the center speaker.

SMALL: When a small speaker is used as the center speaker.

NONE: A center speaker is not connected.

- Press the **PARAMETER SELECTOR** ► button to display the surround speaker size parameter, and press the **PARAMETER CONTROLLER** ◀/► buttons to select "LARGE", "SMALL" and "NONE."

Note:

If you have selected "SMALL" for the front speaker, you can select only "SMALL" or "NONE" for the surround speakers.

LARGE: When large speakers are used as the surround speaker.

SMALL: When small speakers are used as the surround speaker.

NONE: Surround speakers are not connected.

- Press the **PARAMETER SELECTOR** ► button to display the front speaker position parameter, and press the **PARAMETER CONTROLLER** ◀/► button repeatedly to set the distance value from your listening position to the front speaker.

Pressing the **PARAMETER CONTROLLER** ► button repeatedly increases the value.

Pressing the ◀**PARAMETER CONTROLLER** button repeatedly decreases the value.

Set the value closest to the actual distance.

- Press the **PARAMETER SELECTOR** ► button to display the center speaker position parameter, and press the **PARAMETER CONTROLLER** ◀/► buttons to set the center speaker position parameter.

- If you have selected "NONE" for the center speaker in step 4, you cannot set this parameter.

You cannot set the following values:

- Values larger than the front speaker position setting
- Values smaller than the value obtained by subtracting "5ft" from the front speaker setting

- Press the **PARAMETER SELECTOR** ► button to display the surround speaker position parameter, and press the **PARAMETER CONTROLLER** ◀/► buttons to set the surround speaker position parameter.

- If you have selected "NONE" for the surround speakers in step 5, you cannot set this parameter.

You cannot set the following values:

- Values larger than the front speaker position setting
- Values smaller than the value obtained by subtracting "15ft" from the front speaker setting

Speaker setup

9

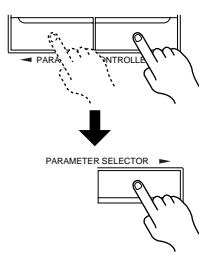

LFE LEVEL = 0 dB
or
LFE LEVEL = -10 dB
or
LFE LEVEL = -∞ dB

10

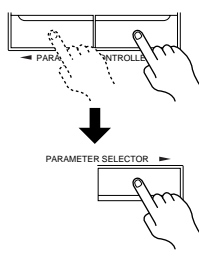

PWR ON VOL = ON
or
PWR ON VOL = OFF

9. Press the **PARAMETER SELECTOR** button to display the **LFE LEVEL** parameter, and press the **PARAMETER CONTROLLER** buttons to set the value.

You can set the LFE LEVEL parameter for the Dolby digital or DTS playback.

In general, leave this parameter to 0dB.

Pressing the **PARAMETER CONTROLLER** buttons repeatedly toggles the values. Display the desired value.

With the Dolby digital sound, the parameter value changes as shown on the left. With the DTS sound, the parameter value changes in the following order: +10dB, 0dB, -∞dB.

Also, refer to "LFE level attenuation" on page 22.

10. Press the **PARAMETER SELECTOR** button. The **POWER ON VOLUME ON/OFF** parameter appears.

Press the **PARAMETER CONTROLLER** buttons to toggle between **ON** and **OFF**.

ON: Power On Volume function is enabled.

OFF: Power On Volume function is disabled.

Display the desired setting and press the **PARAMETER SELECTOR** button.

Refer to page 18 for more information on the Power On Volume function.

Note:

Even if the parameter has already been set to ON, turn it OFF, then turn it ON again to enable the Power On Volume function.

1, 3

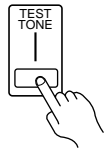

2

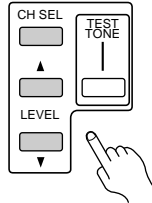

LEFT = +2 dB

Test Tone (Remote controller only)

Use the remote controller and produce the test tone to adjust the level of the connected speakers.

1. Press the **TEST TONE** button.

Each speaker produces the test tone (pink noise) in the following order:

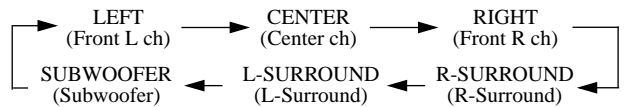

2. To adjust the level of each speaker, press the **CH SEL** button to select a speaker and press the **LEVEL** buttons to raise or lower the level.

The test tone should sound at the same level when you hear it in your listening position. You can adjust the level in the range between -12dB and +12dB.

3. Press the **TEST TONE** button to complete adjustment.

Parameter selector

This chart shows how the display changes when the **PARAMETER SELECTOR** buttons are pressed. Selecting a parameter and pressing the **PARAMETER CONTROLLER** button will change the value or setting for the selected parameter.

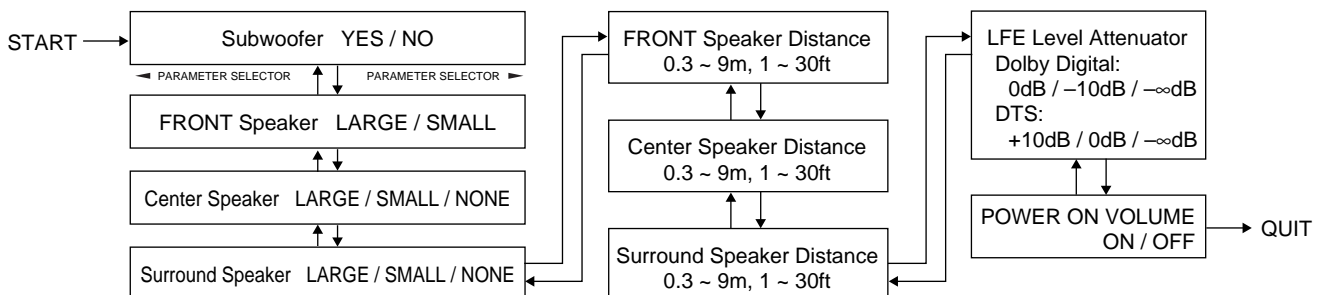

Selecting a sound source

Follow the steps below to select a device to play the sound source.

- 2. Make sure that the SPEAKERS A indicator is lit on the display. If it is not lit, press the SPEAKERS A button.**
(Refer to the "Speakers selector" section on the page 19 for more details.)

- DIMMER button**
Use this button to change the brightness of the display (normal or dim).

- 4. Adjust the volume to an appropriate level.**
These controls allow you to adjust the volume of the Front, Center, Surround speakers and subwoofer simultaneously. Turning the control clockwise increases the volume level. Turning the control counter-clockwise decreases the volume level.

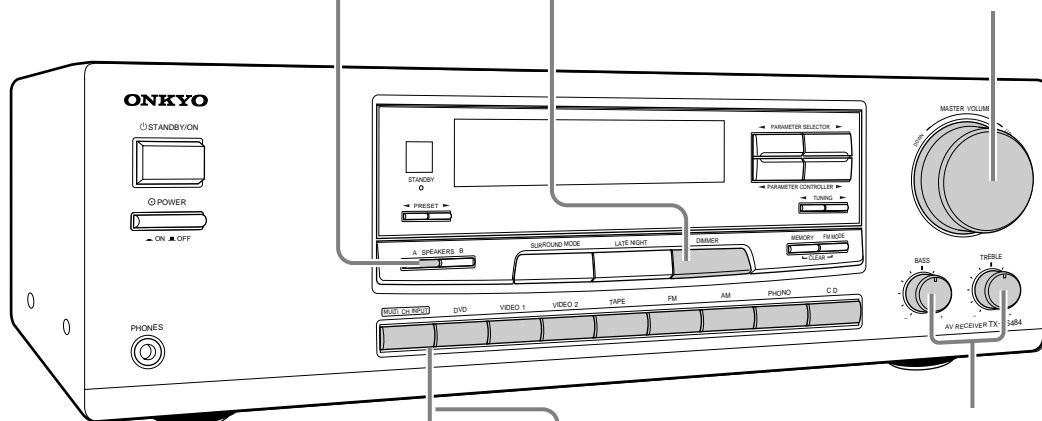

- 1. Press the desired input selector button or MULTI CH INPUT button.**
The selected source name appears on the display. Refer to page 18 for more information on MULTI CH INPUT.

- 3. Start playing the selected input source.**
Follow the operating instructions for the source device.

- 5. Use the bass, treble controls to adjust the tone.**
(Refer to page 19 for more details.)

- 4. VOLUME button (▲ up/▼ down)**
Use this button to adjust the volume level.

- MUTING button**
This button mutes the sound temporarily.
(Refer to page 19 for more details.)

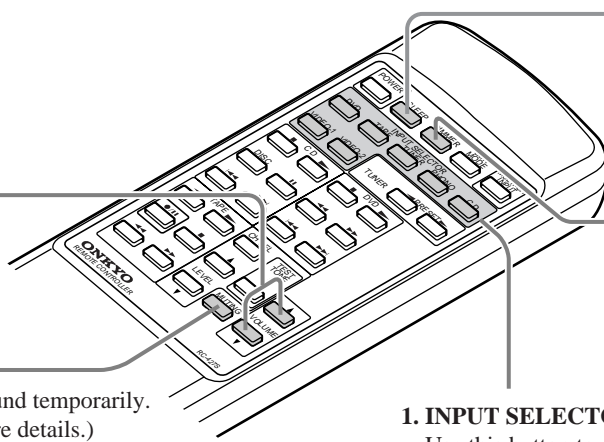

- SLEEP button**
This button allows you to set the sleep timer.
(Refer to page 19 for more details.)

- DIMMER button**
Use this button to change the brightness of the display (normal or dim).

- 1. INPUT SELECTOR button**
Use this button to select a desired sound source.

Note:

If you hear no sound from the speakers, check the following items:

- Make sure that all devices and speakers are connected correctly and securely.
- The sound is muted when the MUTING indicator flashes. Press the MUTING button on the remote controller to cancel the mute function.
- When you select a source that is connected to the DIGITAL INPUT jacks on the rear panel, you must select digital input (refer to page 19.).
- If you have selected MULTI CH INPUT, you need to adjust the level of each speaker (refer to page 18).

Selecting a sound source

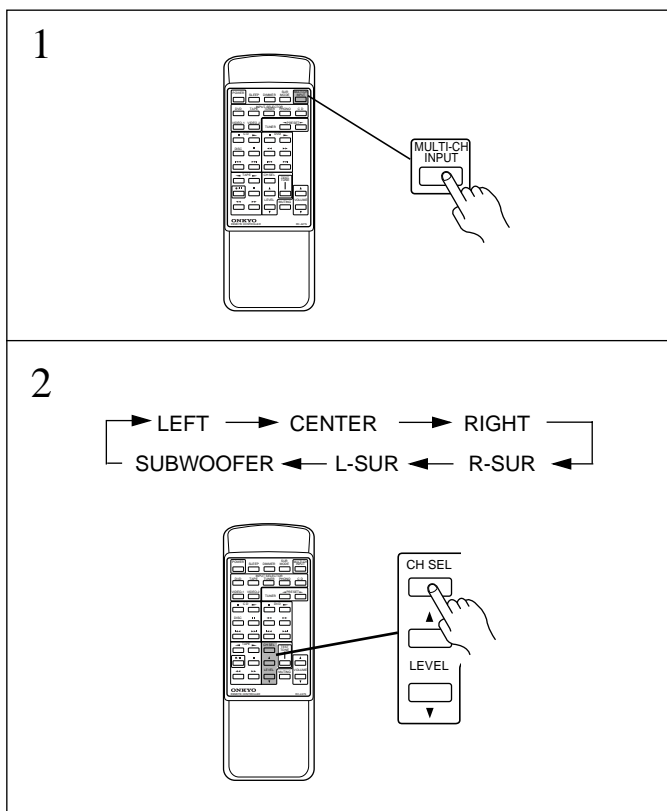

When Multi channel input is selected as a source

Follow the steps below to adjust the level of each speaker if you have selected MULTI CH INPUT.

1. Press **MULTI CH INPUT** button on the remote controller.
You cannot select any Surround mode.
2. Press the **CH SEL** button to select the desired speakers.
3. Use the **LEVEL ▲/▼** button to change the volume level of the speakers.

You can adjust the volume level of each speaker individually. Adjust the level while listening to the sound in the listening position.

You can adjust the level of the front, center, and surround speakers in the range between -12dB and $+12\text{dB}$.

You can adjust the subwoofer level in the range between -30dB and $+12\text{dB}$.

Note

- If the speaker level is set to $+1\text{dB}$ or higher, the maximum level indicated on the display will change if you raise the volume level.

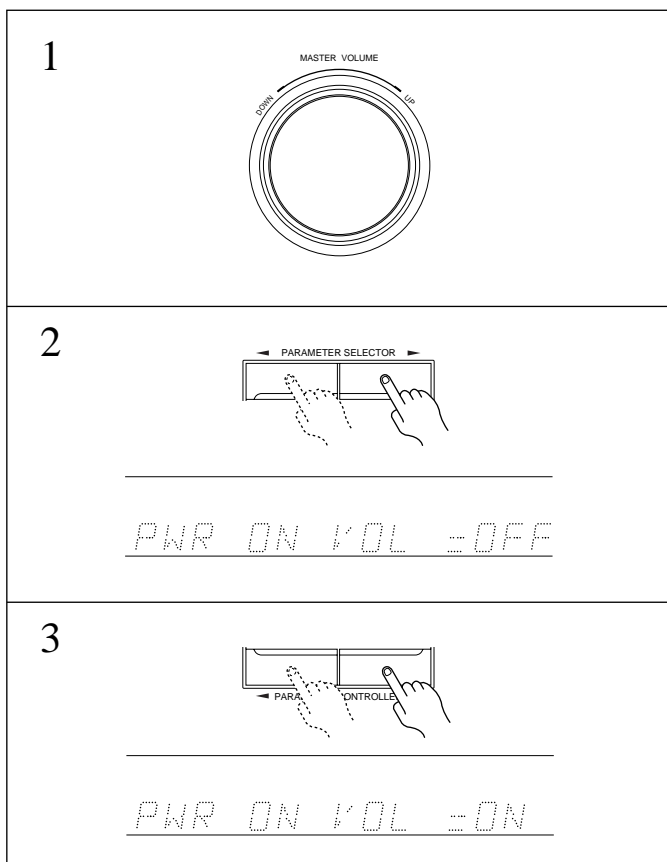

Using the Power On Volume function

This function automatically selects the volume level you set last time.

Follow the steps below:

1. Use the **VOLUME** control to set the desired level.
2. Press the **PARAMETER SELECTOR** ◀ or ▶ button repeatedly to display the “PWR ON VOL” parameter.
The current setting (ON or OFF) appears.
3. Press the **PARAMETER CONTROLLER** ◀ or ▶ button to select “ON.”

Even if the parameter has already been set to ON, turn it OFF, then turn it ON again to enable the Power On Volume function.

The original display appears and the setting is completed. When you turn on the power to the unit next time, it will use the volume level you set in step 1.

Note:

If the PWR ON VOL parameter is set to OFF, the Power On Volume function is disabled. In this case, when you turn on the power to the unit next time, it will use the volume level that was set when you turned off the power.

Selecting a sound source

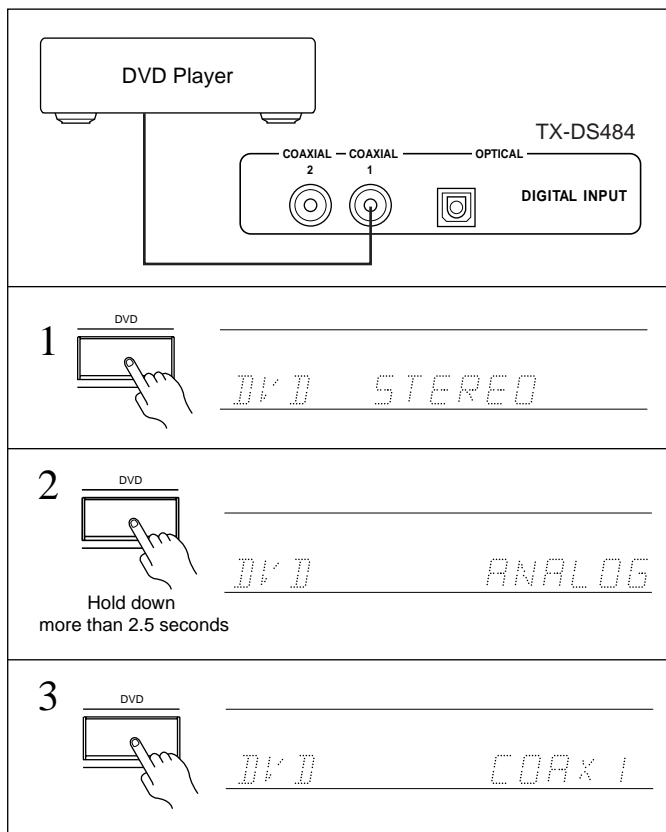

Switching between digital and analog inputs

Either a digital or analog device can be connected to the digital connector. Follow the steps below to select digital or analog according to the type of the connected device. You can assign digital input to DVD, CD, VIDEO1-2, and TAPE. With the default setting, all inputs are assigned analog. Change this assignment, depending on the connected device or sound source. For example, follow the steps below to assign COAX 1 to the digital input jack (COAX 1) that connects a DVD device.

1. Press the DVD Input Selector button.

The DVD input is selected and "DVD" appears on the display.

2. Press and hold the DVD button for about 2.5 seconds.

The current DVD setting (ANALOG, OPT, COAX 1, or COAX 2) appears.

3. Press the DVD button again repeatedly to select "COAX 1."

Pressing the DVD button repeatedly will change the setting as follows:

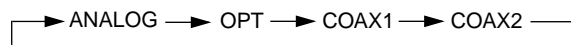

About five seconds after "COAX 1" is selected, the original display appears and the setting is completed.

If you have selected digital input, you can also select the input signal format. Refer to "Setting the input signal format" on page 22.

Warning:

- Do not play CD-ROM discs that contain computer data as they may damage the speakers when the sound is amplified by the receiver.

Speakers selector (SPEAKERS A, B)

SPEAKERS A: This button turns on or off the speakers connected to the FRONT SPEAKERS A, CENTER SPEAKER, SURROUND SPEAKERS and SUBWOOFER terminals.

When the speakers are turned on, the SPEAKERS A indicator lights up.

SPEAKERS B: This button turns on or off the speakers connected to the FRONT SPEAKERS B terminals.

When the speakers are turned on, the SPEAKERS B indicator lights up.

Note:

You cannot use the A and B speakers simultaneously.

You cannot select Surround sound when you are using SPEAKERS B. If you select SPEAKERS B while Surround sound is selected, Surround mode will be automatically canceled.

Be sure to use SPEAKERS A to listen to the sound through MULTI CH INPUT or in any surround mode other than Stereo mode.

Adjusting the tone (BASS, TREBLE)

Treble and bass adjustment is effective only for the Front speakers and headphones.

BASS: Boosts or cuts the bass response.

TREBLE: Boosts or cuts the treble response.

Listening through headphones (PHONES)

You can connect stereo headphones to the PHONES jack using a standard stereo plug.

If you connect headphones, the unit will enter STEREO mode automatically, and no sound will be produced from the speakers. If you have selected MULTI CH INPUT, you will hear sound only from the FRONT L and R channels.

Sleep function (Remote controller only)

The sleep timer can turn off the power to the system after a specified time period.

To set up this function, use the remote controller supplied with this receiver.

1. Start playing the source you would like to listen to (CD, tape, or radio broadcast).

2. Press the SLEEP button repeatedly to set the duration of time after which you want the system to turn off.

The longest timer value you can set is 90 minutes. Pressing the SLEEP button each time reduces the time value in 10-minute increments.

When the specified time comes, the power will be switched off automatically.

Disabling the Sleep function

Press the SLEEP button until it returns to the selected input source name.

or

The timer setting will be cancelled if you turn off the power to the unit.

Temporary muting (MUTING) (Remote controller only)

Press the MUTING button on the remote controller. The MUTING indicator will flash and the sound from the speakers or headphones will be switched off by the receiver's audio muting circuits.

To cancel,

- press the MUTING button again, or
- turn the power off, then turn it on again.

To enjoy Surround mode or Stereo mode

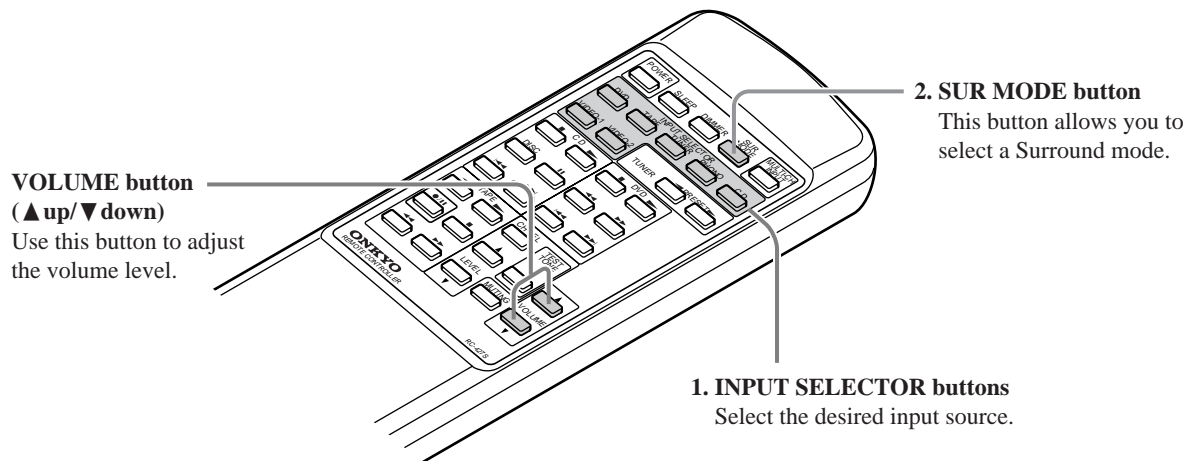
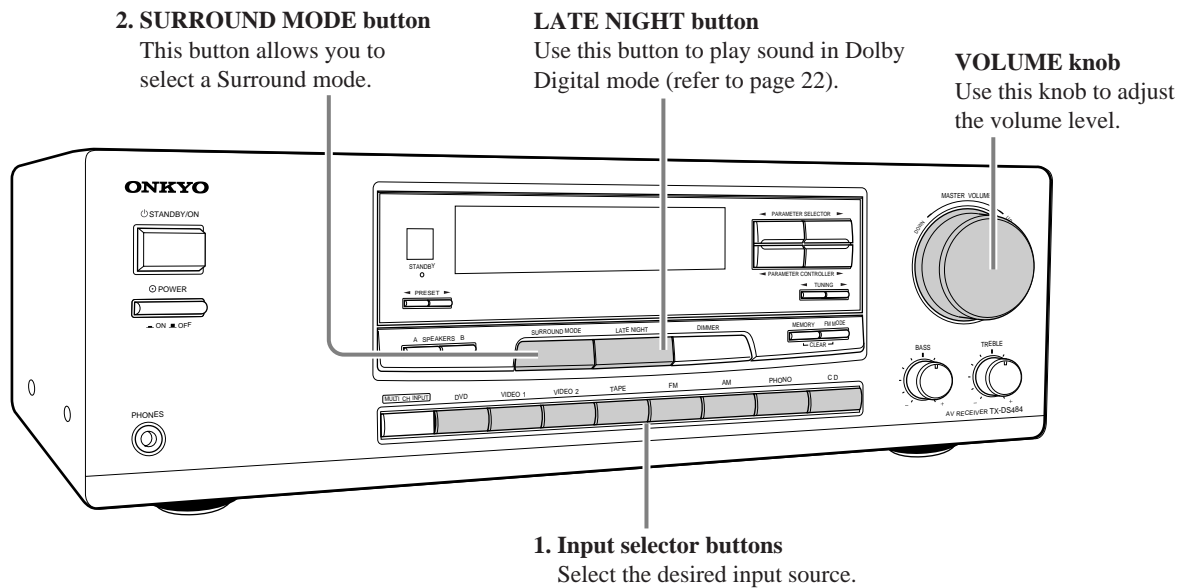

This receiver has six Surround modes. Select a suitable mode according to the type of music you are listening to, the media used, and your personal preference. The selected surround mode is automatically stored along with the selected source. Next time you select the same source again, the stored surround mode will be automatically recalled.

Before Using Surround Mode

Surround Modes

The TX-DS484's surround sound enables you to enjoy the presence of a movie theater or concert hall in your room. Before using a Surround mode, make sure the Speaker Setup parameters have been set (refer to page 14). Once the parameters have been set, it is not necessary to set them again. The configuration of the speakers are very important for the surround sound. Refer to "connecting speakers" on page 10.

DOLBY DIGITAL Surround, DTS (Digital Theater System) Surround

This 5.1-channel digital surround format enables you to individually record and play five full-range (20Hz–20kHz) channels (left and right front, center, two surround channels) plus an LFE channel (Low Frequency Effect) for the low-range effect sound. It will create a realistic sound that could be heard in the theaters and concert halls.

DOLBY DIGITAL: Select this option when you play a DVD video that has a  mark.

DTS: Select this option when you play a DVD player, laser disc, or CD that has a  mark.

To enjoy Surround mode or Stereo mode

DOLBY PRO LOGIC

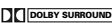
This surround format consists of four channels (left and right front, center, and monaural surround channels) and emphasizes the center channel. This format is very effective for panning music, conversation, and three-dimensional sound movement output from three front channels. It also simulates the atmosphere and surround effects of the sound reflected from the side and rear walls of the theater. Select this option when you play a VHS, VHS Hi-Fi, laser disc, or DVD video that has a  mark.

Onkyo's Surround modes

The TX-DS484 offers the following special Onkyo Surround modes for the sources other than Dolby Digital and DTS sounds.

ORCHESTRA: This mode is suitable for classics and opera music. The center channel is cut and the surround channels are emphasized to widen the stereo image. It will simulate a natural reverberation that can be created in a large hall.

UNPLUGGED: This mode is suitable for acoustic instrumental sounds, vocals, and jazz music. By emphasizing the front stereo image, it will simulate the acoustics in front of the stage.

5CH STEREO: This mode is useful for background music. The front and surround channels will create a stereo image.

STEREO

Select this mode when you do not wish to use the surround mode. All input sound is output from the front speakers.

• A system with L/R front and center speakers

The following modes are available:

DOLBY 3STEREO

The surround channel sound is output from the left and right front speakers.

STEREO

This is a normal stereo mode. Surround mode is cancelled.

• A system with L/R front speakers

The following mode is available:

STEREO

This is a normal stereo mode.

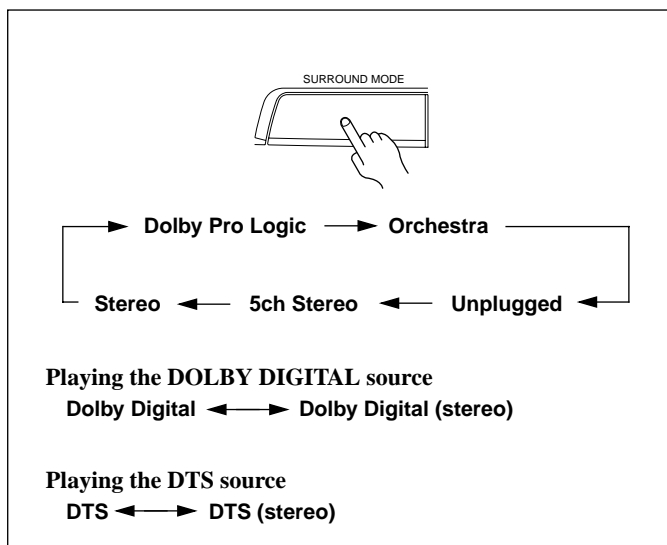

You can adjust the level of each speaker if necessary.

1. Use the CH SEL button on the remote controller to select the target speaker.
2. Use the LEVEL ▲ or ▼ button to adjust the level.

When you place the receiver in Standby mode, this level will be reset to the value set for the test tone. Also, if you press the TEST TONE button after adjusting the speaker level, it will use the level value set for the test tone.

Notes on DTS

1. If you play a CD or LD that supports DTS when the "ANALOG" setting is selected on the TX-DS484, the DTS encoded signal will not be decoded and noise will be output. This noise could damage the amplifier and speakers. Therefore, be sure to select "DIGITAL" and use the digital input jacks (OPTICAL/COAXIAL) to connect the DTS source. (Refer to "Switching between digital and analog inputs" on page 19.)
2. If you play a CD or LD that supports DTS when the "DIGITAL" setting is selected, you may hear a noise for a short while until the DTS decoder recognizes the DTS encoded signal and starts operating. This is not a malfunction.
3. If you press the PAUSE or SKIP button on the player while playing a DTS source, a short noise may be heard. This is not a malfunction.
4. The DTS indicator on the TX-DS484 lights up while it plays the DTS source. When playback concludes and the DTS signal transmission stops, the TX-DS484 remains in DTS mode and the DTS indicator remains lit. This prevents noise when you operate the PAUSE or SKIP button on the player. Therefore, if the source switches from the DTS signal to the PCM signal immediately, the PCM signal may not be played. In this case, stop the playback of the source on the player for about three seconds, then resume playback.
5. Some CD players and LD players may be unable to play DTS sources correctly even if you connect the player to the TX-DS484 digitally. This is because the digital signal has been processed (such as the output level, sampling frequency, frequency response, etc.), and the TX-DS484 cannot recognize the signal as DTS data. Therefore, you may hear noise when you play a DTS source while processing the signal.
6. The Rec Out jacks of the TX-DS484 output analog audio. Do not record CDs or LDs that support DTS using these jacks. Otherwise, you will record a DTS encoded signal as noise.

Selecting a Surround mode

1. Press an Input Selector button to select the desired sound source.
2. Press the SURROUND MODE button repeatedly until the desired Surround mode name appears.
The display changes in the order shown on left each time you press the button.
 - If you are using the remote controller, press the SUR MODE button to select the desired Surround mode.
 - If DOLBY PRO LOGIC is selected during playback of a DOLBY DIGITAL or DTS source, the Surround mode automatically changes to DOLBY DIGITAL or DTS and the DOLBY DIGITAL indicator or DTS indicator lights up on the display.
 - If you have set the surround speaker parameter for the speaker setup (see page 14) to "NONE," STEREO or 3 STEREO will be selected for Surround mode
3. Play the selected sound source.

To enjoy Surround mode or Stereo mode

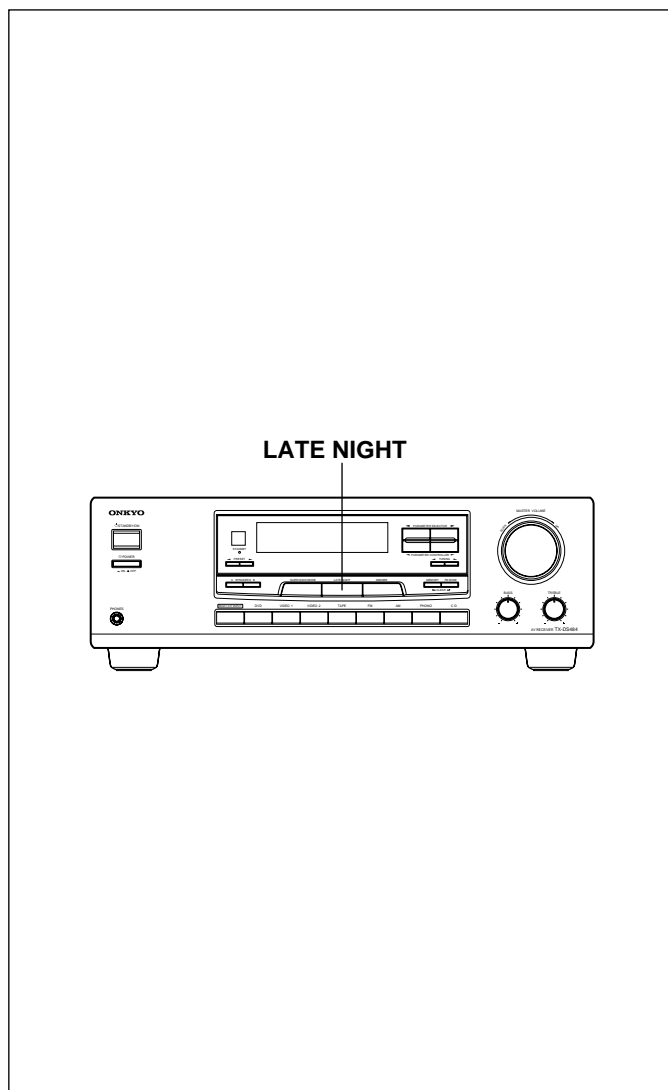

Setting the Surround mode parameters

LATE NIGHT

If you play a movie at a low volume at night, set this parameter to “ON” to narrow the dynamic range of the sound to make it easier to hear.

The Late Night function works only with source material that contains necessary Dolby Digital information.

Press the LATE NIGHT button. The LATE NIGHT indicator appears on the display. To cancel the LATE NIGHT function, press the LATE NIGHT button again.

- The Late Night function is available only in Dolby Digital Surround mode.
- The degree of the Late Night effect is already programmed into the source materials. Some materials may produce only small or no effects.

LFE (Low Frequency Effect) Level Attenuation

This control function enables you to adjust the level of LFE in the Dolby Digital/DTS Surround sound.

How to set this parameter is explained in the “Speaker setup” section on page 14.

Notes:

- The LFE Level Control function is effective only on the Dolby Digital/DTS Surround sound.
- The degree of the low frequency effect is already programmed into the source materials. Some materials may produce only small or no effects.

Dolby Digital sound:

“0dB” is recommended. If the low range sounds too loud for your taste, select -10dB or -∞dB.

DTS sound:

“+10dB” is recommended for cinema sound sources. If the low range sounds too loud for your taste, select 0dB or -∞dB. “0dB” is recommended for music sound source. If the low range sounds too loud for your taste, select -∞dB.

Setting the input signal format

If the input source is DVD, CD, VIDEO 1, VIDEO 2, or TAPE, you can specify the input signal format. The default setting is “AUTO.” However, you can change this according to the signal format of the input source.

For example, follow the steps below to specify the input signal format for the DVD input:

1. Press the DVD button.

DVD is selected as the input source and “DVD” appears on the display.

2. Select the desired input signal format using the DVD button.

Pressing the DVD button repeatedly will change the format option as follows:



Press the DVD button repeatedly to display the desired format. After five seconds, the original display appears and the setting is completed.

Note:

You need to assign digital input to DVD to specify the input signal format. (Refer to “Switching between digital and analog inputs” on page 19 for more information.)

AUTO (Auto Detect mode)

In this mode, the unit automatically detects the input signal format (Dolby Digital, DTS, or PCM) and performs necessary decoding process. If the digital signal is not being input, the unit will play the signal input from the analog input jacks.

DIGITAL (Digital Input Auto Detect mode)

In this mode, the unit automatically detects the input signal format (Dolby Digital, DTS, or PCM) and performs necessary decoding process.

ANALOG (Analog Audio Signal Process mode)

The unit plays the audio signal that is input from the device connected to the analog input jacks.

Tuning in a radio station

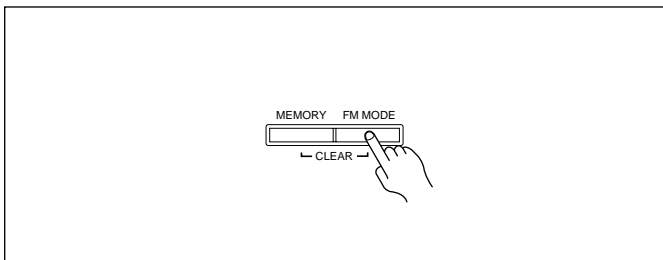
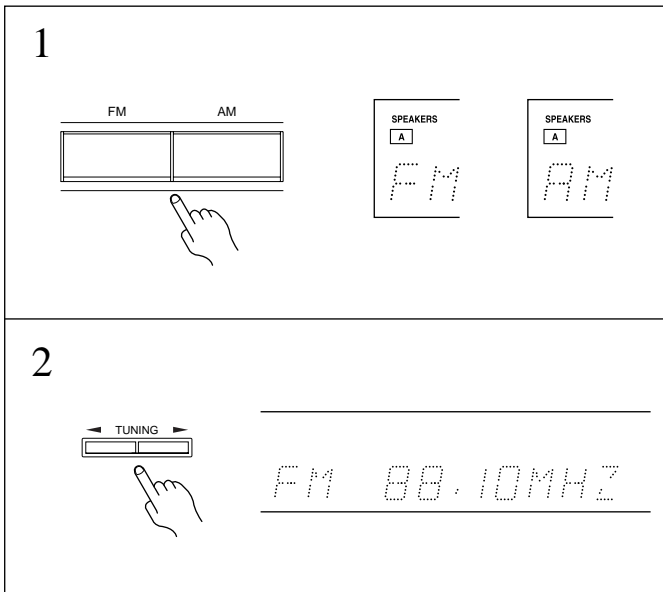
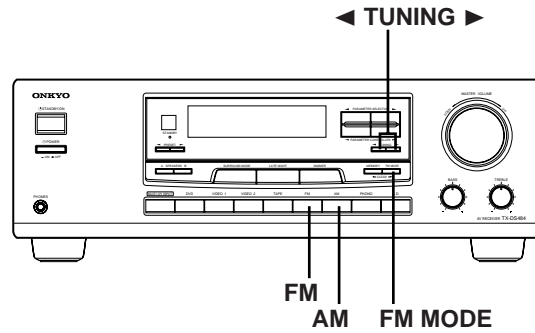

Manual tuning

1. Press the FM or AM button.
2. Use the TUNING \leftarrow/\rightarrow buttons to change the frequency.

▶ (up)..... the frequency increases.
 ◀ (down)..... the frequency decreases.

- The frequency changes in 50 kHz steps in FM and 10 kHz (or 9 kHz) in AM each time you press the TUNING \leftarrow/\rightarrow button.
- In FM, if this button is held continuously for more than 0.5 seconds, the frequencies are scanned automatically (FM auto tuning mode). When a broadcast is received, scanning stops.

Receiving RDS (European model only)

When an RDS (Radio Data System) station broadcasting PS (Program Service Name) information is received, the RDS indicator lights up and the name of the station is displayed.

- RDS reception is only available on the European model, and only in areas where RDS broadcasts are available.

Listening to a stereo radio station (FM mode)

When you tune in a stereo FM station, the FM STEREO indicator lights up if the signal is sufficiently strong.

If the signal is weak, it may be impossible to tune in to the desired station. In this case, tune in as follows.

Press the FM MODE button. The FM MUTE indicator turns off. At this time, the station will be in mono and interstation noise will be heard. Select the station to which you want to listen.

Using preset radio stations

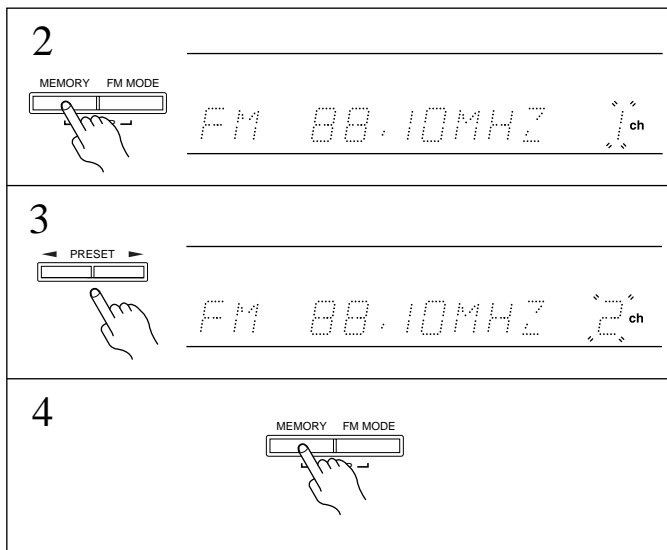
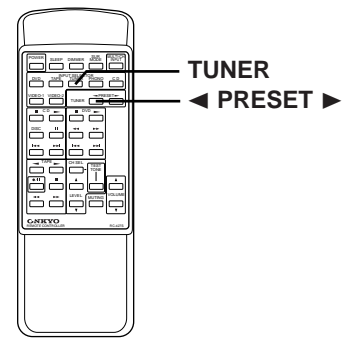
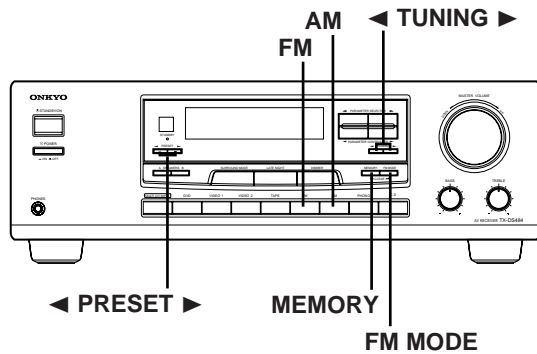

Programming radio stations

1. Select the frequency that you want to store in the memory. (See Tuning in a radio station on page 23.)
 2. Press the **MEMORY** button. The MEMORY indicator will light up for eight seconds.
 3. Select the desired memory number using **PRESET** ◀/▶ button.
 4. Press the **MEMORY** button.
- Total of 30 stations can be stored in the memory.

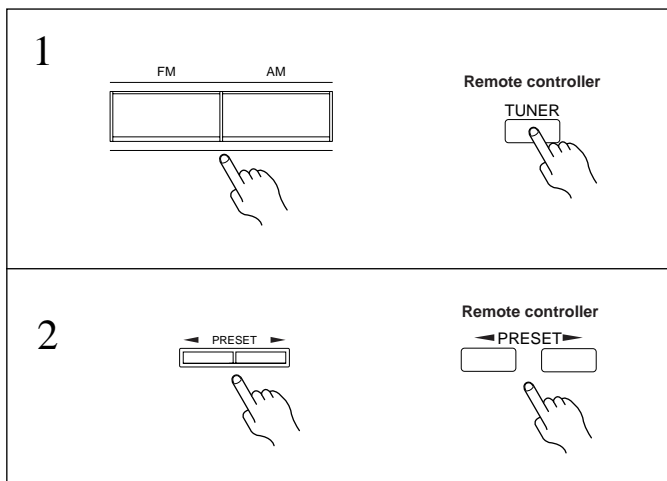

Selecting a preset station

1. Select the tuner as the source by pressing the AM or FM input selector button on the main unit.
2. Enter the desired preset number using the **PRESET** ◀ and ▶ buttons.

Remote controller operation

1. Select the tuner as the source by pressing the TUNER input selector button on the remote controller.
2. Press the **PRESET** (◀ or ▶) button.

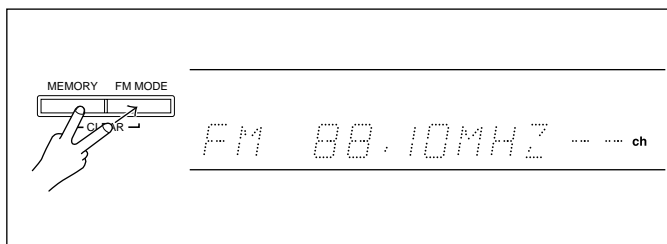

Cancelling preset stations

1. Select the preset station you wish to remove as explained in the previous section.
 2. Press the **FM MODE** button while holding down the **MEMORY** button. “--” appears on the channel display.
- Once the preset station has been cancelled, the memory location can be used to store another station.

Recording a source

- You can record analog Audio, but not digital audio. Make sure that you have made a correct analog connection.
- You cannot record the source connected to MULTI CH INPUT jack.
- If you select another device as the input source during recording, the input signal from that device will be recorded.
- You cannot record audio source along with the surround effects.

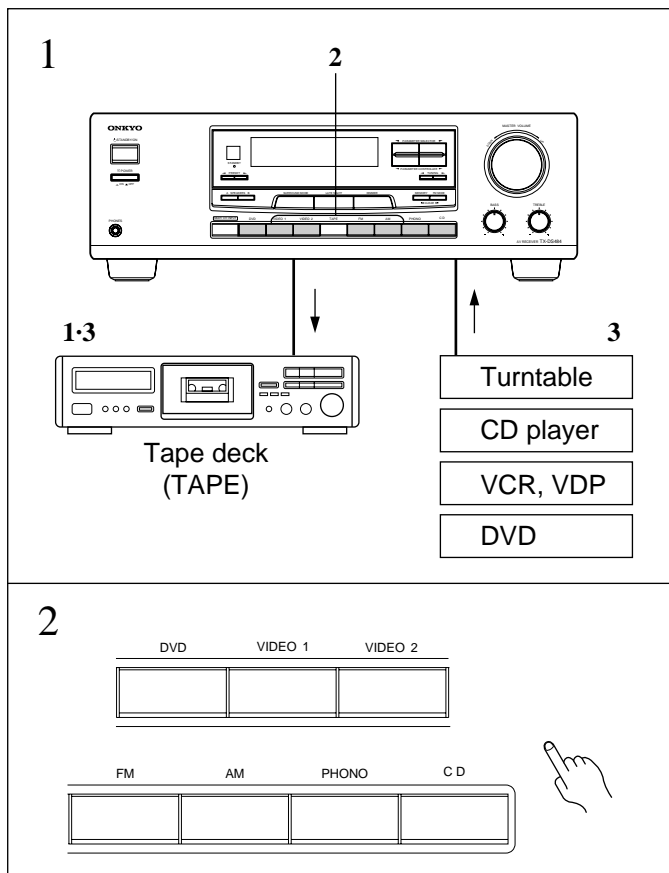

Recording an audio source

Make all connections between the tape deck and the receiver as shown in the “Audio equipment connections” diagram (page 6).

- 1. Insert a blank tape into the tape deck.**
- 2. Press the input selector button for the source you want to record.**
 - If you select DVD, VIDEO 1 or VIDEO 2, only the audio will be recorded.
 - If you select FM or AM, set the tuner to the station you want to record.
- 3. Set the tape deck in recording mode. Start playing the source.**

Set the proper recording level using the controls on the tape deck.

 - Please read the corresponding instruction manuals for more information on how to operate the corresponding equipment.

Recording a source

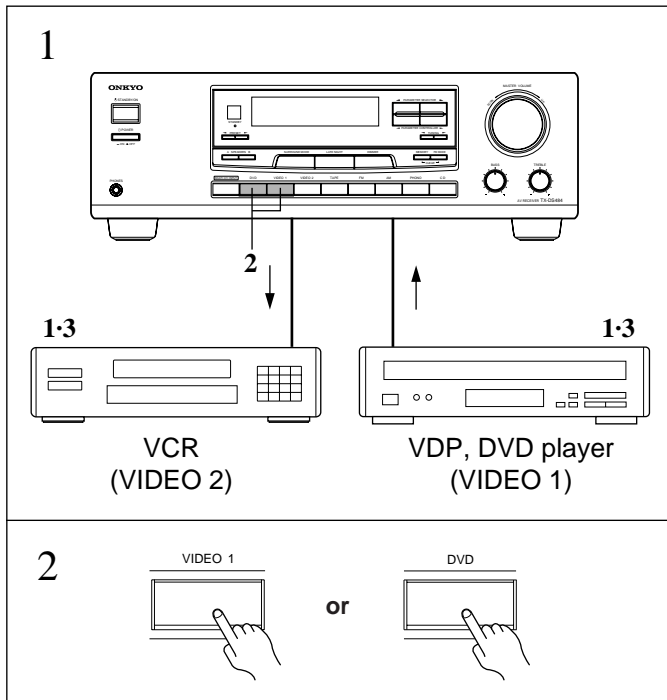

Recording data from a video disc player (or a video camcorder) to VCR

Video disc programs can be recorded onto a VCR (VIDEO 2).

1. Load a disc in the video disc player or DVD player, and insert a blank tape in the VCR (VIDEO 2).
2. Press the VIDEO 1 or DVD button.
3. Start playing the video disc player and recording on the VCR.

- Refer to the Video equipment connections section on the page 7.

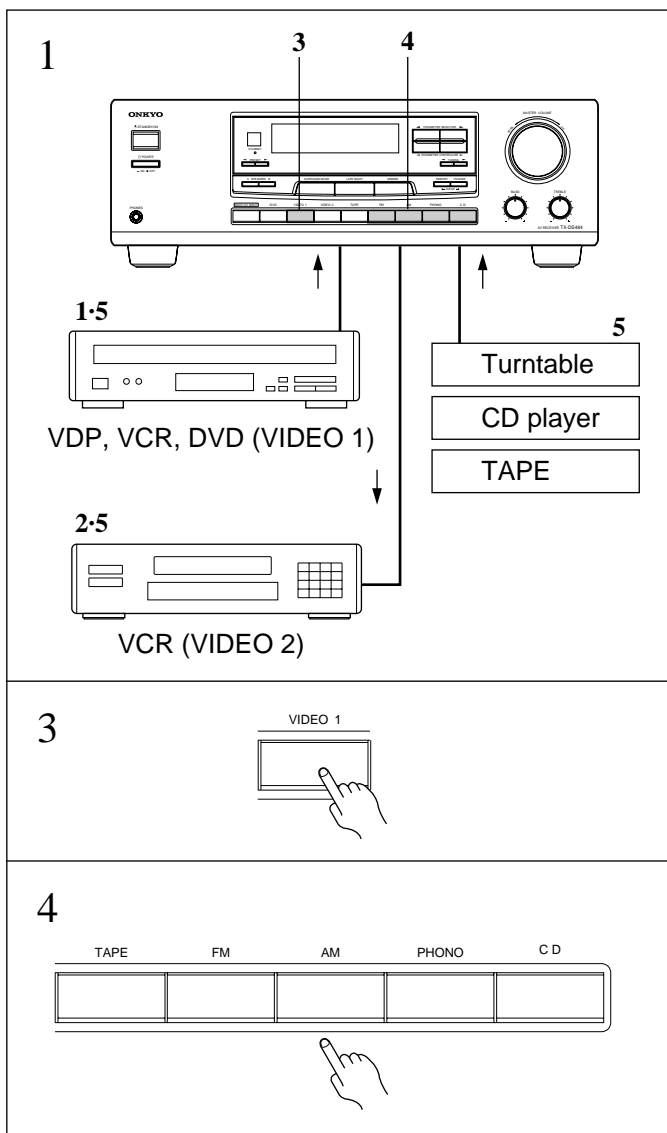

Adding new sound to a video tape during video editing

During video tape editing, you can add sound to the recording VCR from various audio program sources.

1. Insert the disc or tape that you want to record into the player connected to VIDEO 1.
2. Insert a blank video tape in the VCR connected to VIDEO 2.
3. Press the VIDEO 1 button.
4. Select the audio program source (FM, AM, PHONO, CD, TAPE).
5. Start playing the video connected to the VIDEO 1 terminal and start playing the sound source. Then, start recording on the VCR that is connected to the VIDEO 2 terminal.

- Refer to the video disc player, video camcorder, DVD or VCR instruction manuals for additional information.

Troubleshooting guide

If a problem occurs while you are using the remote controller, first try to operate the front panel controls on the main unit to make sure that it is not due to a malfunction (or worn out batteries) in the remote controller.

Trouble	Cause	Remedy	See page
No power.	<ul style="list-style-type: none"> Power cord is disconnected. There is external noise in the computer circuits of this unit. AC fuse blown. 	<ul style="list-style-type: none"> Connect power cord. Turn the power button off and then on again or remove the AC plug from the outlet and then plug it again. Contact your Onkyo Service Center. 	11 11 –
Power on but no sound.	<ul style="list-style-type: none"> MUTING indicator is lit. Bad connections. Amplifier protection circuitry has been activated. ('PROTECT' will be displayed.) 	<ul style="list-style-type: none"> Press the MUTING button on the remote controller to turn it off. Check connections, speaker leads, etc. Contact your Onkyo Service Center. 	19 10 –
No sound from the center speaker, or very minimal sound.	<ul style="list-style-type: none"> Speaker cable is not corrected. Surround mode is set to Orchestra, Unplugged, 5ch Stereo. CENTER level is set to minimum. CENTER SPEAKER is set to NONE. 	<ul style="list-style-type: none"> Check the connection between the amplifier and the speaker. If Surround mode is set to Orchestra, Unplugged, or 5ch Stereo, the center speaker outputs only the effect sound. Set the CENTER level to the appropriate volume. Set CENTER SPEAKER to LARGE or SMALL. 	10 21 16 15
Hum, low-frequency noise.	<ul style="list-style-type: none"> Poor or no input ground. Poor or no phono motor ground. The placement of the audio connection cables on the rear panel is incorrect. 	<ul style="list-style-type: none"> Check outer conductor of input plugs. Check for proper ground connection. Adjust the placement of the cable to reduce hum. 	6 6 –
Howling when the volume is turned up.	<ul style="list-style-type: none"> Turntable and speakers are too close together. 	<ul style="list-style-type: none"> Move them farther apart. 	–
Rough or scratchy sound. High range is not clear.	<ul style="list-style-type: none"> Stylus of turntable pick-up is worn. Turntable stylus tip is dirty. Treble control too high. 	<ul style="list-style-type: none"> Replace. Clean. Turn treble control down. 	–
AM stations cannot be received.	<ul style="list-style-type: none"> AM loop antenna is not attached. 	<ul style="list-style-type: none"> Connect the included AM loop antenna to the AM antenna terminals. 	13
Buzzing noise on AM (particularly conspicuous at night or with weak stations).	<ul style="list-style-type: none"> Noise from electrical apparatus such as fluorescent lamp. 	<ul style="list-style-type: none"> Move the AM loop antenna to different position. Set up an outdoor AM antenna. 	13 13
High-pitched noise or buzzing noise on AM.	<ul style="list-style-type: none"> Noise from TV set. 	<ul style="list-style-type: none"> Place the AM loop antenna as far as possible from the TV. Move unit away from TV set. 	13 –
Crackling noise on AM, FM.	<ul style="list-style-type: none"> Noise caused by turning fluorescent lamp on and off. Noise from automobile ignition. 	<ul style="list-style-type: none"> Move antenna as far as possible from the fluorescent lamp. Install an FM outdoor antenna as far as possible from the road. Change the position or direction of the outdoor antenna. 	13
TUNED and STEREO indicators light but sound is distorted and stereo separation is bad.	<ul style="list-style-type: none"> Station is too strong. Multiple reflection of the radio waves because of tall buildings or mountains. 	<ul style="list-style-type: none"> Change to FM indoor antenna. Use antenna which has better directivity and select a point where the distortion is least. 	12 13
TUNED and STEREO indicators flicker and hiss is heard on FM.	<ul style="list-style-type: none"> Station is too weak. Stereo FM broadcasts cover only about half the distance of an ordinary broadcast. 	<ul style="list-style-type: none"> Install an outdoor FM antenna. Change the position or direction of the outdoor antenna. 	13
No station is recalled.	<ul style="list-style-type: none"> The power cord has been unplugged or the POWER switch has been turned off for a long time. 	<ul style="list-style-type: none"> The memory contents are lost. Store all stations again. 	24
Front panel controls function but remote controller does not.	<ul style="list-style-type: none"> No batteries in remote controller. Batteries have worn out. 	<ul style="list-style-type: none"> Insert batteries. Replace batteries. 	5 5
The sound of the playback source is not heard.	<ul style="list-style-type: none"> The input selector is not set properly. 	<ul style="list-style-type: none"> Set it to the playback source. 	17

Also refer to the respective instruction manuals of the video disc player, video cassette recorder, TV monitor, etc., that compose your entertainment system.

Specifications

AMPLIFIER SECTION

Continuous Average Power output (FTC)

All channels: 55 watts per channel min. RMS at 8 ohms, 2 channels driven from 20 Hz to 20 kHz with no more than 0.08% total harmonic distortion. 70 watts min. RMS at 6 ohms, 2 channels driven from 1 kHz with no more than 0.1% total harmonic distortion.

Continuous Power output (DIN) 75 watts \times 5 at 6 ohms
Maximum Power output (EIAJ) 100 watts \times 5 at 6 ohms
Total Harmonic Distortion: 0.08% at rated power (Front)
IM Distortion: 0.08% at rated power (Front)
Damping Factor: 60 at 8 ohms (Front)

Input Sensitivity and Impedance

PHONO: 2.5 mV, 50 kohms
LINE (CD, TAPE, DVD, VIDEO 1, 2): 200 mV, 50 kohms

MULTICHANNEL INPUT

(FRONT L/R, SURROUND L/R, CENTER): 200 mV, 50 kohms
(SUBWOOFER): 36 mV, 50 kohms
DIGITAL 2 (COAXIAL): 0.5 Vp-p, 75 ohms
VIDEO IN

(DVD, VIDEO 1, 2): 1 Vp-p, 75 ohms

Output Level and Impedance

Rec out (TAPE, VIDEO 2): 200 mV, 2.2 kohms
Pre out (SUBWOOFER): 1 V, 2.2 kohms
VIDEO OUT

(VIDEO 2, MONITOR): 1 Vp-p, 75 ohms

Phono Overload: 110 mV RMS at 1 kHz, 0.5% T.H.D.

Frequency Response: 20 Hz to 100 kHz, $\pm 1/-3$ dB

RIAA Deviation: 20 Hz to 20 kHz, ± 0.8 dB

Tone Control

Bass: ± 10 dB at 50 Hz
Treble: ± 10 dB at 10 kHz

Signal-to-Noise Ratio

Phono: 80 dB (IHF A, 5 mV input)
CD/Tape: 100 dB (IHF A)

VIDEO SECTION

Signal sensitivity and impedance: 1 Vp-p, 75 ohms (DVD, VIDEO 1, VIDEO 2 input, output)

TUNER SECTION

FM

Tuning Range: 87.5 — 108.0 MHz
Usable Sensitivity
Mono: 11.2 dBf, 1.0 μ V (75 ohms)
Stereo: 17.2 dBf, 2.0 μ V (75 ohms)
50 dB Quieting Sensitivity
Mono: 17.2 dBf, 2.0 μ V (75 ohms)
Stereo: 37.2 dBf, 20 μ V (75 ohms)
Capture Ratio: 2.0 dB
Image Rejection Ratio
U.S.A. & Canadian models: 40 dB
Other area models: 85 dB

IF Rejection Ratio: 90 dB
Signal-to-Noise Ratio
Mono: 76 dB
Stereo: 70 dB
Alternate Channel Attenuation: 55 dB
Selectivity: 50 dB (DIN)
AM Suppression Ratio: 50 dB
Total Harmonic Distortion
Mono: 0.2%
Stereo: 0.3%
Frequency Response: 30 Hz — 15 kHz, ± 1.0 dB
Stereo Separation: 45 dB at 1 kHz
30 dB at 100 Hz — 10 kHz

AM

Tuning Range
U.S.A. & Canadian models: 530—1,710 kHz (10 kHz steps)
European & Australian models: 522—1,611 kHz (9 kHz steps)
Worldwide models: 531—1,602 kHz (9 kHz steps), 530—1,710 kHz (10 kHz steps)
Usable Sensitivity: 30 μ V
Image Rejection Ratio: 40 dB
IF Rejection Ratio: 40 dB
Signal-to-Noise Ratio: 40 dB
Total Harmonic Distortion: 0.7%

GENERAL

Power Supply: AC 120 V, 60 Hz
AC 230 V, 50 Hz
AC 220-230 V and 120 V switchable, 50/60 Hz
Power Consumption: 3.4 A
260 W
Dimensions (W \times H \times D): 435 \times 150 \times 333 mm
17-1/8" \times 5-7/8" \times 13-1/8"
Weight: 9.7 kg, 21.4 lbs.
10.3 kg, 22.7 lbs.
11.1 kg, 24.5 lbs.

REMOTE CONTROL

Transmitter: Infrared
Signal range: Approx. 5 meters, 16 ft.
Power supply: Two "AA" batteries (1.5 V \times 2)

Specifications and features are subject to change without notice.

Power supply and voltage vary depending on the area in which the unit is purchased.

Control positions and names

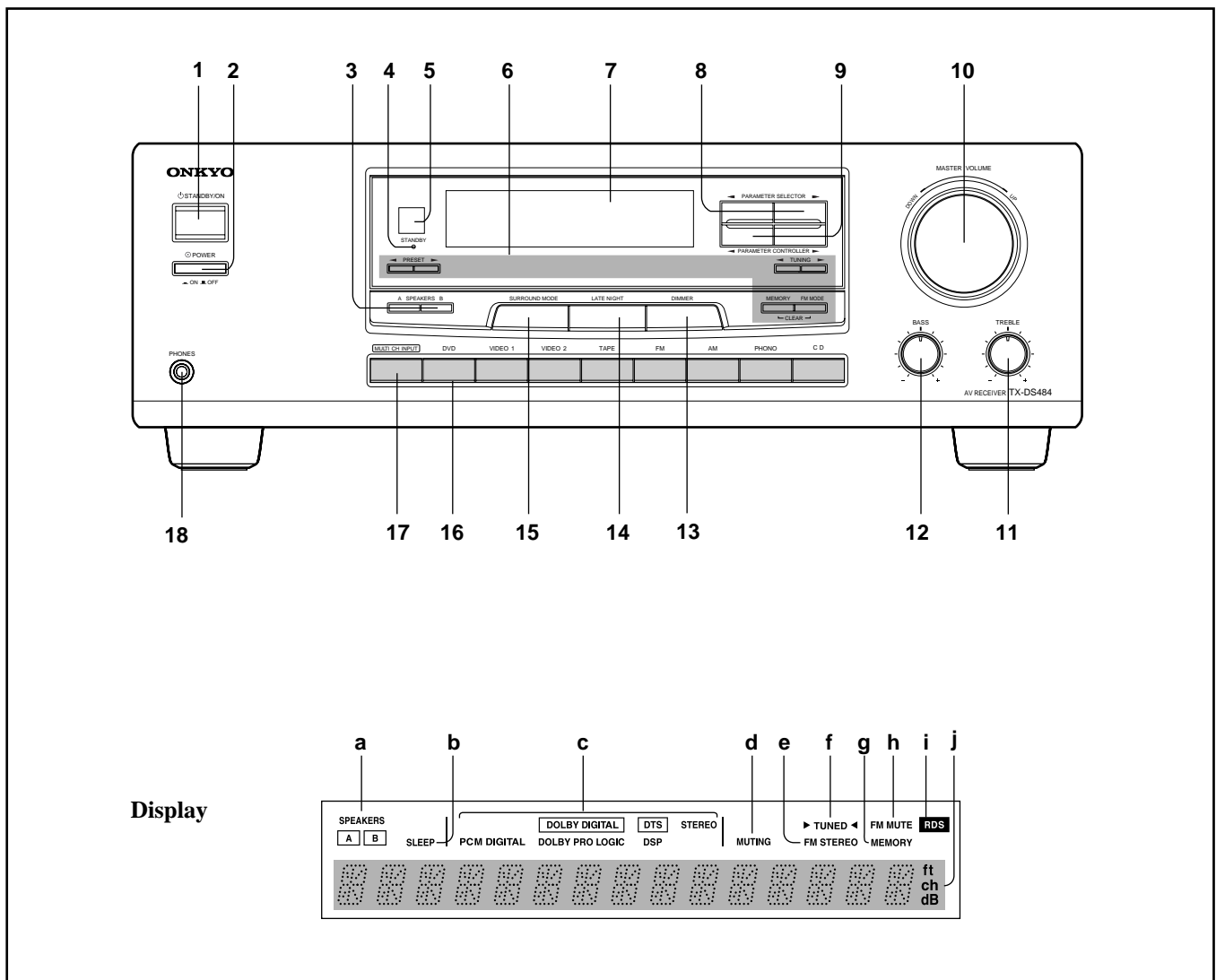

Front panel

For more information about buttons or knobs, refer to the pages listed in the brackets ([]) below.

1. STANDBY/ON button [9, 11]
2. POWER switch [9, 11]
3. SPEAKERS A/B button [17, 19]
4. STANDBY indicator [5, 11]
5. Remote control sensor [5]
6. TUNER operation buttons
PRESET ◀/▶ buttons [24]
TUNING ◀/▶ buttons [23, 24]
FM MODE button [23, 24]
MEMORY button [24]
7. Display (Refer to the “Display” illustration.)
8. PARAMETER SELECTOR buttons [14~16]
9. PARAMETER CONTROLLER buttons [14~16]
10. MASTER VOLUME control knob [17, 18]
11. TREBLE control knob [17, 19]
12. BASS control knob [17, 19]
13. DIMMER button [17]
14. LATE NIGHT button [20, 22]
15. SURROUND MODE button [20, 21]
16. Input selector buttons [17, 20]
17. MULTI CH INPUT button [17, 18]
18. PHONES jack [19]

Display

If a protective film on the surface of the screen making it difficult to read the display, remove the film.

- a. Speakers A/B indicators
- b. Sleep indicator
- c. Surround Mode indicators
- d. Audio Mute indicator
- e. FM Stereo indicator
- f. Tuned indicators
- g. Memory indicator
- h. FM Mute On/Off indicator
- i. RDS station received indicator (European model only)
- j. Multi function display (Frequency and Preset station/Input selector/Sleep time/Volume level)

Remote controller RC-427S

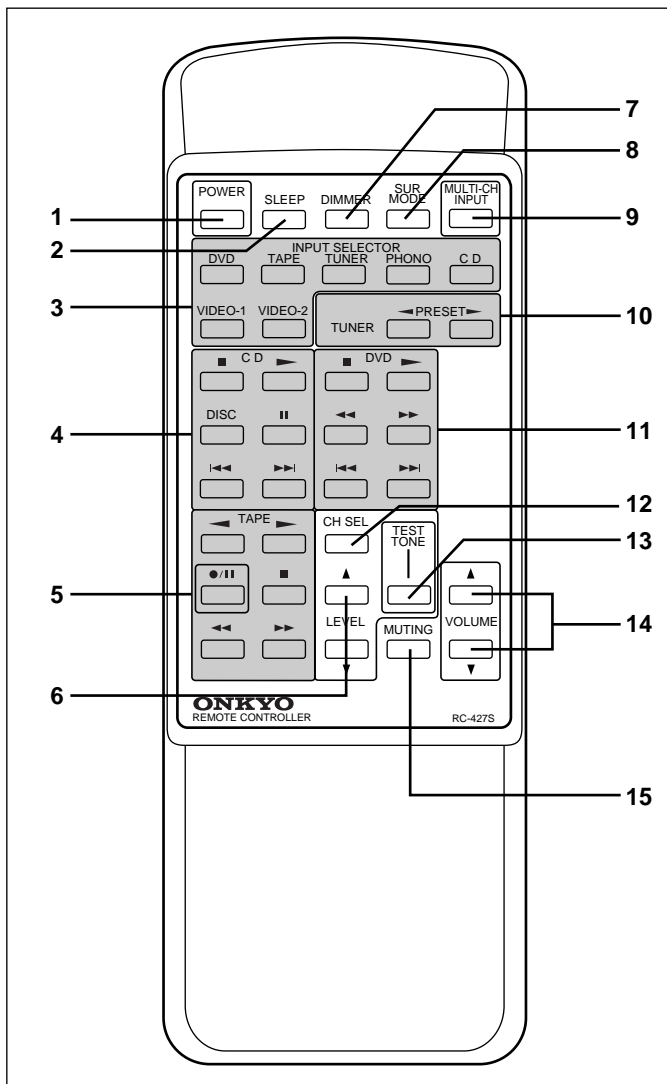

1. Power button (POWER) [11]
2. Sleep button (SLEEP) [17, 19]
3. Input selector buttons [17]
4. CD operation buttons [31]
5. Tape operation buttons [31]
6. Level up/down button (LEVEL ▲/▼) [14, 16, 18]
7. DIMMER button (DIMMER) [17]
8. Surround mode button (SUR MODE) [20, 21]
9. Multi channel input button [18]
10. Tuner operation buttons (TUNER) [24, 31]
 ◀PRESET▶ : — Preset memory up/down buttons
11. DVD operation buttons [31]
12. Channel selector button (CH SEL) [14, 16, 18]
13. Test tone button (TEST TONE) [14, 16]
14. Volume buttons (VOLUME ▲/▼) [17]
 Volume control for the Front, Center, Surround and Sub-woofer speakers.
15. Audio muting button (MUTING) [17, 19]

Using the remote controller

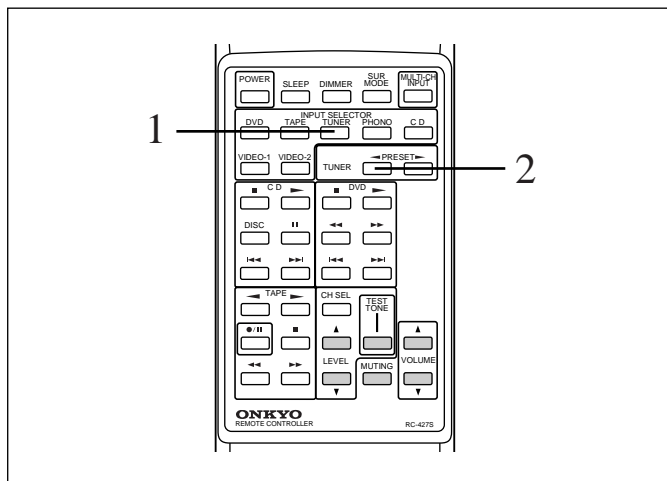

Listening to the radio

1. Press the **TUNER** button.
2. Use the **PRESET** buttons to select the desired station.

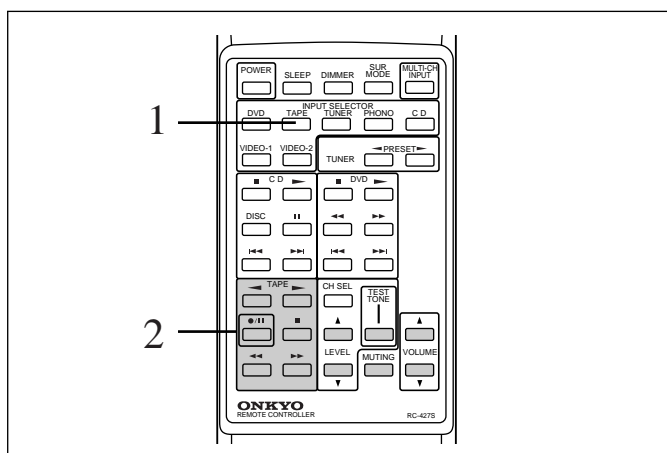

Using an Onkyo tape deck

These buttons enable you to control ONKYO cassette tape decks that can be remotely controlled. (Refer to page 9.)

1. Press the **TAPE** button.
2. Press the transport buttons.
 - ◀ Reverse play
 - ▶ Forward play
 - /⏸ Recording/pause
 - Stop
 - ⏮ Fast Rewind
 - ⏭ Fast Forward

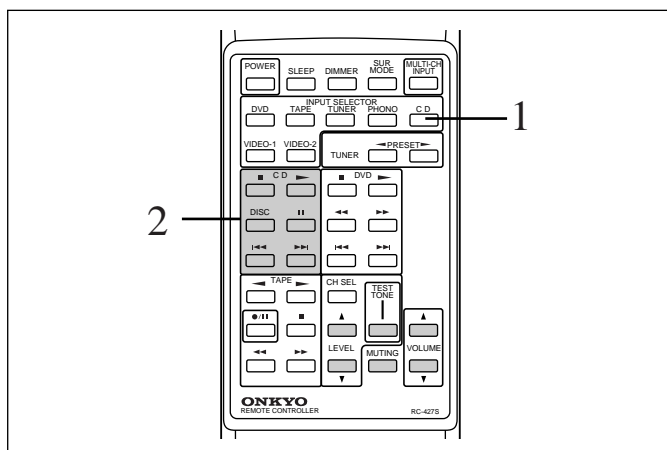

Using an Onkyo CD player

These buttons enables you to control ONKYO CD players that can be remotely controlled. (Refer to page 9.)

1. Press the **CD** button.
2. Press the transport buttons.
 - ▶ Play
 - ⏸ Pause
 - Stop
 - ⏮ Down
 - ⏭ Up
 - DISC Select a CD changer tray.

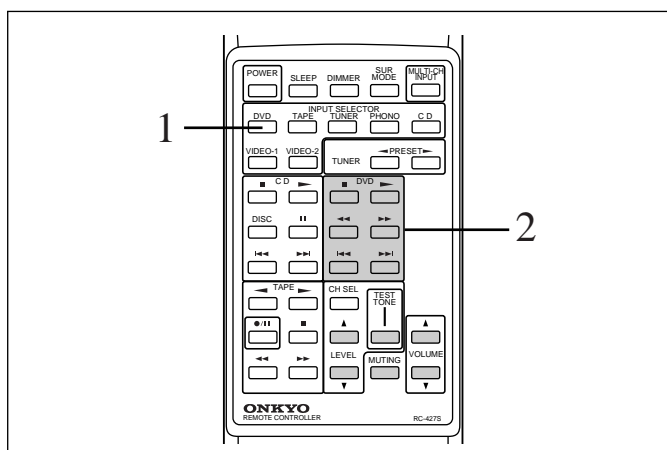

Using an Onkyo DVD player

These buttons enable you to control ONKYO DVD players that can be remotely controlled. (Refer to page 9.)

1. Press the **DVD** button.
2. Press the transport buttons.
 - ▶ Play
 - Stop
 - ⏮ Down
 - ⏭ Up
 - ⏮ Fast Rewind
 - ⏭ Fast Forward

ONKYO CORPORATION

Sales & Product Planning Div. : 2-1, Nisshin-cho, Neyagawa-shi, OSAKA 572-8540, JAPAN
Tel: 072-831-8111 Fax: 072-833-5222 <http://www.onkyo-intl.com>

ONKYO U.S.A. CORPORATION

18 Park Way, Upper Saddle River, N.J. 07458, U.S.A.
Tel: 201-785-2600 Fax: 201-785-2650 <http://www.onkyousa.com>

ONKYO EUROPE ELECTRONICS GmbH

Liegnitzerstrasse 6, 82194 Groebenzell, GERMANY
Tel: +49-8142-4401-0 Fax: +49-8142-4401-555 <http://www.onkyo.net>

ONKYO CHINA LIMITED

Units 2102-2107, Metroplaza Tower I, 223 Hing Fong Road, Kwai Chung,
N.T., HONG KONG Tel: 852-2429-3118 Fax: 852-2428-9039 <http://www.onkyochina.com>

ONKYO
HOMEPAGE
<http://www.onkyo.co.jp/>