

**ONKYO®**

**Powered Subwoofer**

***SL-107***

**Contents**

**English ..... En-1**

**Instruction Manual**

Thank you for purchasing an Onkyo powered subwoofer. Please read this manual thoroughly before using the unit. Following the instructions in this manual will enable you to obtain optimum performance and listening enjoyment from your new powered subwoofer. Please retain this manual for future reference.

**En**

**WARNING:**

TO REDUCE THE RISK OF FIRE OR ELECTRIC SHOCK, DO NOT EXPOSE THIS APPARATUS TO RAIN OR MOISTURE.

**CAUTION:**

TO REDUCE THE RISK OF ELECTRIC SHOCK, DO NOT REMOVE COVER (OR BACK). NO USER-SERVICEABLE PARTS INSIDE. REFER SERVICING TO QUALIFIED SERVICE PERSONNEL.



**WARNING**  
RISK OF ELECTRIC SHOCK  
DO NOT OPEN

**AVIS**  
RISQUE DE CHOC ELECTRIQUE  
NE PAS OUVRIR



The lightning flash with arrowhead symbol, within an equilateral triangle, is intended to alert the user to the presence of uninsulated "dangerous voltage" within the product's enclosure that may be of sufficient magnitude to constitute a risk of electric shock to persons.



The exclamation point within an equilateral triangle is intended to alert the user to the presence of important operating and maintenance (servicing) instructions in the literature accompanying the appliance.

## Important Safety Instructions

1. Read these instructions.
2. Keep these instructions.
3. Heed all warnings.
4. Follow all instructions.
5. Do not use this apparatus near water.
6. Clean only with dry cloth.
7. Do not block any ventilation openings. Install in accordance with the manufacturer's instructions.
8. Do not install near any heat sources such as radiators, heat registers, stoves, or other apparatus (including amplifiers) that produce heat.
9. Do not defeat the safety purpose of the polarized or grounding-type plug. A polarized plug has two blades with one wider than the other. A grounding type plug has two blades and a third grounding prong. The wide blade or the third prong are provided for your safety. If the provided plug does not fit into your outlet, consult an electrician for replacement of the obsolete outlet.
10. Protect the power cord from being walked on or pinched particularly at plugs, convenience receptacles, and the point where they exit from the apparatus.
11. Only use attachments/accessories specified by the manufacturer.
12. Use only with the cart, stand, tripod, bracket, or table specified by the manufacturer, or sold with the apparatus. When a cart is used, use caution when moving the cart/apparatus combination to avoid injury from tip-over.
 

PORTABLE CART WARNING



S3125A
13. Unplug this apparatus during lightning storms or when unused for long periods of time.
14. Refer all servicing to qualified service personnel. Servicing is required when the apparatus has been damaged in any way, such as power-supply cord or plug is damaged, liquid has been spilled or objects have fallen into the apparatus, the apparatus has been exposed to rain or moisture, does not operate normally, or has been dropped.
15. Damage Requiring Service
 

Unplug the apparatus from the wall outlet and refer servicing to qualified service personnel under the following conditions:

  - A. When the power-supply cord or plug is damaged,
  - B. If liquid has been spilled, or objects have fallen into the apparatus,
  - C. If the apparatus has been exposed to rain or water,
  - D. If the apparatus does not operate normally by following the operating instructions. Adjust only those controls that are covered by the operating instructions as an improper adjustment of other controls may result in damage and will often require extensive work by a qualified technician to restore the apparatus to its normal operation,
  - E. If the apparatus has been dropped or damaged in any way, and
  - F. When the apparatus exhibits a distinct change in performance this indicates a need for service.
16. Object and Liquid Entry
 

Never push objects of any kind into the apparatus through openings as they may touch dangerous voltage points or short-out parts that could result in a fire or electric shock.

The apparatus shall not be exposed to dripping or splashing and no objects filled with liquids, such as vases shall be placed on the apparatus.

Don't put candles or other burning objects on top of this unit.
17. Batteries
 

Always consider the environmental issues and follow local regulations when disposing of batteries.
18. If you install the apparatus in a built-in installation, such as a bookcase or rack, ensure that there is adequate ventilation.
 

Leave 20 cm (8") of free space at the top and sides and 10 cm (4") at the rear. The rear edge of the shelf or board above the apparatus shall be set 10 cm (4") away from the rear panel or wall, creating a flue-like gap for warm air to escape.

# Precautions

## 1. Recording Copyright

Unless it's for personal use only, recording copyrighted material is illegal without the permission of the copyright holder.

## 2. AC Fuse

The AC fuse inside the SL-107 is not user-serviceable. If you cannot turn on the SL-107, contact your Onkyo dealer.

## 3. Care

Occasionally you should dust the SL-107 all over with a soft cloth. For stubborn stains, use a soft cloth dampened with a weak solution of mild detergent and water. Dry the SL-107 immediately afterwards with a clean cloth. Don't use abrasive cloths, thinners, alcohol, or other chemical solvents, because they may damage the finish or remove the panel lettering.

## 4. Power

### WARNING

BEFORE PLUGGING IN THE UNIT FOR THE FIRST TIME, READ THE FOLLOWING SECTION CAREFULLY.

AC outlet voltages vary from country to country. Make sure that the voltage in your area meets the voltage requirements printed on the SL-107's rear panel (AC 220–230 V, 50/60 Hz).

## 5. Placement

- The enclosure is made of wood and is therefore sensitive to extreme temperatures and humidity. Avoid placing the unit in locations subject to direct sunlight or in humid places, such as near an air conditioner, bathroom or kitchen, as well as in locations subject to soot or steam, such as near a kitchen table or humidifier. Otherwise, damage may occur.
- Keep water or other liquids away from the unit. If water is spilled into the unit, not only the unit but also the connected amplifier (or receiver) may be damaged.
- Place the unit on a level and rigid surface free from vibration.
- Four slip-proof spacers are provided with the SL-107. If the SL-107 is to be placed on flooring or other similar surfaces, attach these spacers to the bottom surface at the corners. This will not only prevent scratching, but also provide a stable footing. However, note that depending on the surface, the spacers may leave markings.
- This unit is designed to be used in an upright vertical position only. Do not use it in a horizontal or tilted position.
- If the unit is used near a turntable or CD player, feedback or skipping of sound may occur. To prevent this, move the unit away from the turntable or CD player or otherwise lower the unit's output level.

## 6. Color

In catalogs and on packaging, the letter added to the end of the product name indicates the color of the SL-107. Specifications and operation are the same regardless of color.

## 7. Precaution on use

If the following abnormal signals are fed to the speaker, however, an overcurrent may flow in the internal circuits, causing burning or breakage of the wires:

1. Special test signals produced by audio checking CD, etc.
2. Sound produced when connecting or disconnecting audio connection cables
3. Feedback when a microphone is used
4. Abnormal sound produced when bass-range signals are excessively boosted by the amplifier's (or receiver's) tone controls, a graphic equalizer, or a source with an abnormally boosted bass range. This state, called "rattling," occurs when the signal is beyond the driver's reproduction capacity. Although it is not a sign of damage, decrease the speaker output level to prevent damage to the driver.

## Features

- This subwoofer system is equipped with a built-in amplifier solely for the reproduction of the superbass range.
- With the built-in left-right mixing circuit and cut-off filter, you can simply connect the unit to your existing system to enjoy powerful bass reproduction.

## Supplied Accessories

- Pin connector cable
- Cork spacers (4 pcs.)

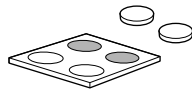

### Using cork spacers with SL-107

We recommend using the provided cork spacers to achieve the best possible sound from your speaker. The cork spacers prevent the speaker from moving, providing a more stable setup.

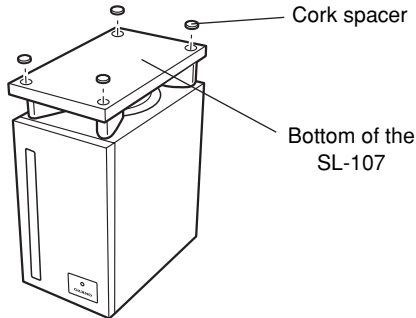

## Contents

Important Safety Instructions .....	1
Precautions .....	2
Features .....	3
Supplied Accessories.....	3
Controls .....	4
Connections .....	5
Subwoofer effects.....	7
Adjustments .....	7
Placement .....	7
Troubleshooting .....	8
Specifications.....	8

### Declaration of Conformity

We, ONKYO EUROPE  
ELECTRONICS GmbH  
LIEGNITZERSTRASSE  
6, 82194 GROEBENZELL,  
GERMANY



declare in own responsibility, that the ONKYO product described in this instruction manual is in compliance with the corresponding technical standards such as EN60065, EN55013, EN55020 and EN61000-3-2, -3-3.

GROEBENZELL, GERMANY

  
I. MORI

ONKYO EUROPE ELECTRONICS GmbH

# Controls

**FRONT VIEW**

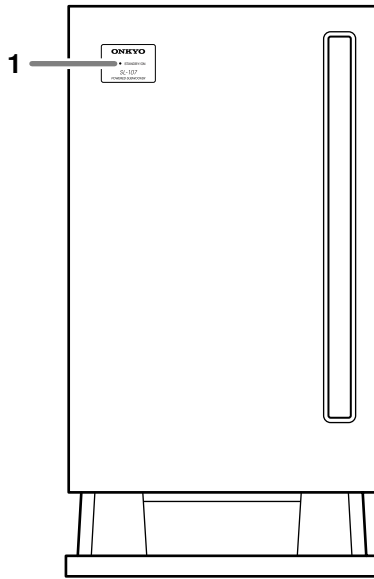

**REAR PANEL**

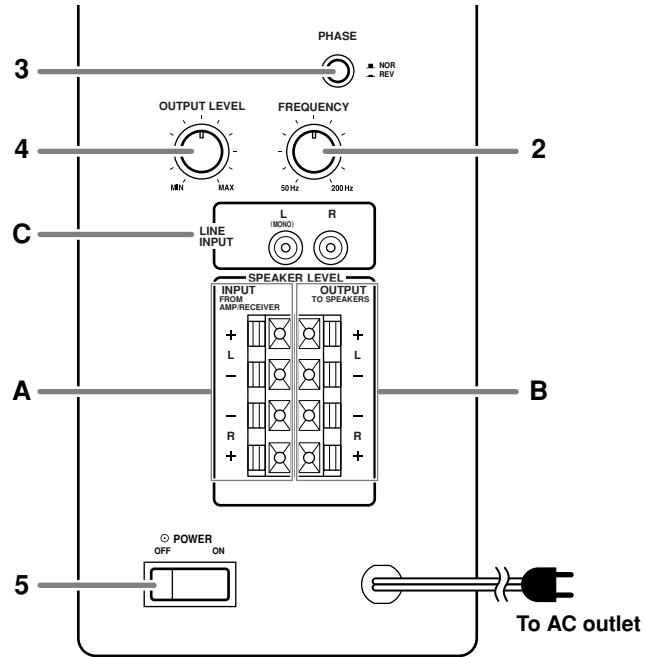

**1 Standby/On indicator (STANDBY/ON)**

This indicator lights up when the power switch is set to the ON position.

Red: The unit is in Standby mode

Green: The unit is in Operational mode

If the power is turned on, the SL-107 automatically enters Operational mode when a signal is input.

The SL-107 automatically returns to Standby mode when no signal has been input for about 20 minutes.

**2 FREQUENCY knob**

Use this knob to select the high-frequency range at which to cut off the signal to the subwoofer.

You can select any frequency between 50 Hz and 200 Hz, depending on the characteristics of the speaker system.

**3 PHASE switch**

Use this switch to reverse the phase of the SL-107.

Normally, set the switch to the “NOR” position.

Depending on the connected speakers or the installation environment of the SL-107 however, the “REV” position may result in better sound. Select the switch position that produces a louder bass sound.

**4 OUTPUT LEVEL knob**

Use this knob to adjust the output level of the subwoofer.

**5 POWER switch**

Press this switch to the ON position to turn on the power. Press it to the OFF position to turn off the power.

**A SPEAKER LEVEL INPUT terminals**

Connect these input terminals to the speaker output terminals of your amplifier or receiver.

**B SPEAKER LEVEL OUTPUT terminals**

The speaker-level signal to the front speakers is output from these terminals.

**C LINE INPUT jacks**

Connect these jacks to the LINE OUT jacks on the amplifier etc.

**Note:**

The auto standby function engages if the input signal level is constant. If the auto standby function does not operate properly, try slightly increasing (or decreasing) the subwoofer output level of the receiver.

# Connections

For safety considerations, turn off the power to this unit and all other system components before you connect or disconnect any component.

## Using the SL-107 with an AV amplifier

When using the SL-107 in conjunction with an AV amplifier or receiver that features surround capability, connect the SL-107 to SUBWOOFER PREOUT jack using the supplied pin connector cable. If you use speaker cable to make the connection, depending on the amplifier or receiver settings, the bass signals may cut out, resulting in decreased fidelity in the low bass range. For more information on proper connection procedures, refer to the instruction manual supplied with your amplifier or receiver.

### Connecting to an amplifier's SUBWOOFER PREOUT jack

If your amplifier (or receiver) is equipped with SUBWOOFER PREOUT jack, connect it to the SL-107's left LINE INPUT jack.

#### Amplifier with SUBWOOFER PREOUT jack

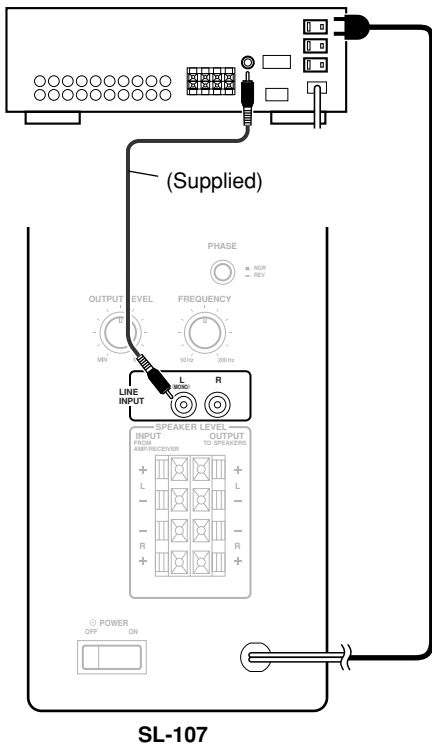

**Connecting two channel outputs (when your amplifier does not have SUBWOOFER PREOUT jack):** If your preamplifier is equipped with two channel outputs, connect them to the right and left LINE INPUT jacks on the SL-107.

#### Preamplifier / Pre-main amplifier

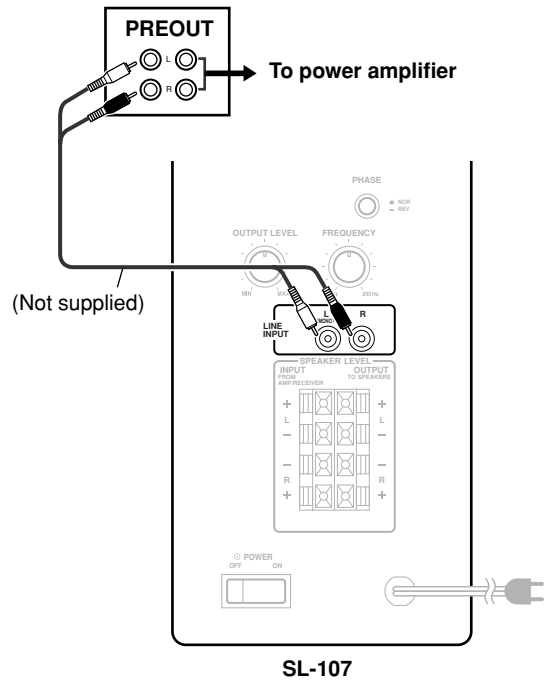

## Connections—Continued

### Connecting to speaker terminals on an amplifier (or receiver)

1. Using the speaker cables, connect the SL-107 SPEAKER LEVEL INPUT terminals to the amplifier's speaker terminals.
2. Using the speaker cables, connect the right and left speakers to the SL-107 SPEAKER LEVEL OUTPUT terminals.

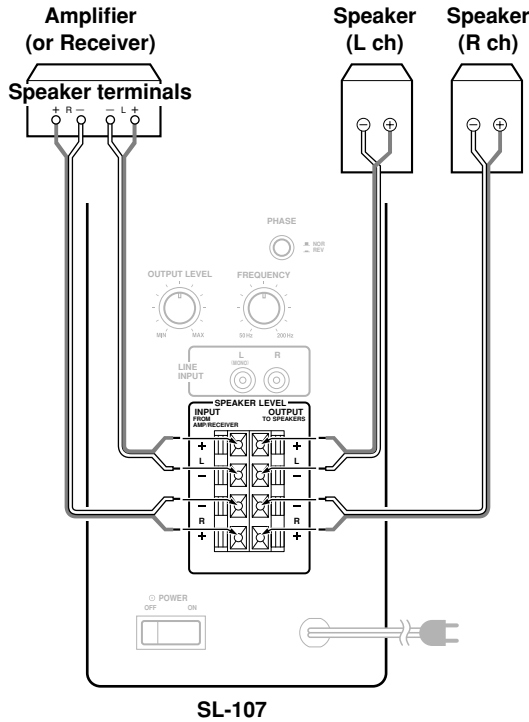

### Notes:

- When connecting speaker cables, do not mistake the (+) and (–) or the L (left) and R (right) terminals. If you connect the speaker cables incorrectly, there will be a loss of fidelity in the bass range.
- The speakers connected to the SL-107 SPEAKER LEVEL OUTPUT terminals must have an impedance equal to or greater than the rating indicated on the amplifier connected to the SPEAKER LEVEL INPUT terminals. Otherwise, the amplifier may be damaged.
- When you connect the speaker cables, make sure the core wires do not make contact with other terminals or metallic parts of the unit.
- Do not use BTL (Balanced Transformer-Less) type amplifiers. Using a BTL amplifier may damage both the amplifier and the subwoofer. Ordinary amplifiers are not BTL amplifiers. For more information, see the amplifier's instruction manual.



### • Connecting the speaker cables

1. Twist the core wires at the stripped end of the cable.
2. Press the lever of the SPEAKER LEVEL terminal, fully insert the twisted core wires into the terminal hole, and then release the lever.
3. Pull the speaker cable gently to ensure that it is connected firmly.

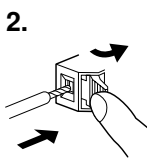
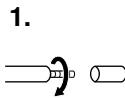

## Subwoofer effects

Adding a subwoofer to your speaker system expands the bandwidth of the bass range. However, if the subwoofer's reproduction bandwidth or sound output level is improperly adjusted, the overall performance may decrease, as shown in the graphs below.

### When the subwoofer's reproduction bandwidth is correct

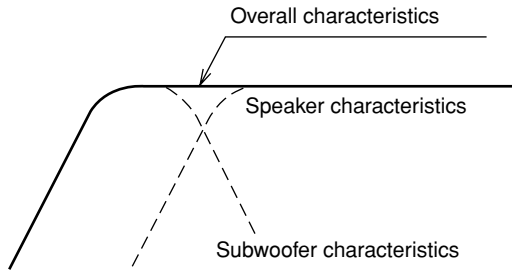

### When the subwoofer's output level is incorrect

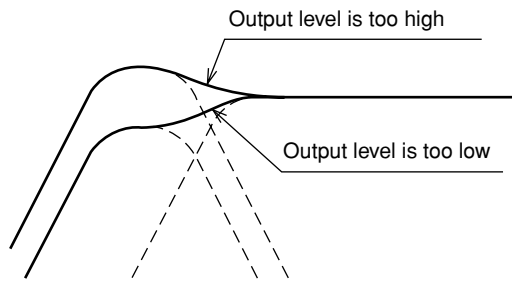

### When the subwoofer's reproduction bandwidth is far from the speaker's bandwidth

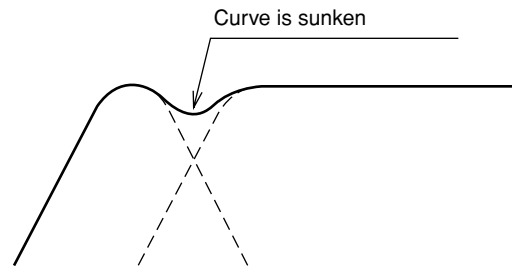

### When the subwoofer's reproduction bandwidth is close to the speaker's bandwidth

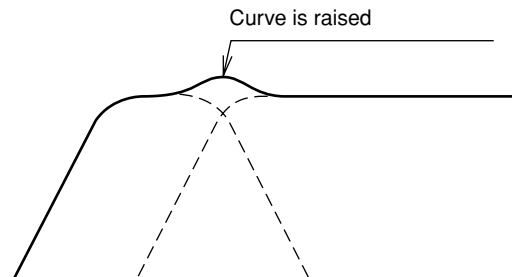

En-7

## Adjustments

### Crossover frequency and output level

- Adjust the SL-107 output level and crossover frequency to suit your listening room and connected speakers.
- When the unit is connected to an amplifier via the SPEAKER LEVEL INPUT terminals, setting the OUTPUT LEVEL knob near the center position will create a well-balanced sound level on most speakers.
- Be aware that you might set the subwoofer to a high output level because superbass-range sound is less audible than other sound ranges. To obtain well-balanced frequency characteristics, set the output level to a slightly lower level than seems optimal. (This will also prevent the input of signals that are too strong.)

### Note:

Be careful not to allow the input of excessive power. Input levels that greatly exceed normal situations can damage the SL-107. Also note that switching operations at the amplifier may generate excessive noise that may result in damage. When using switches at the amplifier, first lower the volume to prevent accidental damage.

## Placement

The placement of the SL-107 can greatly affect the sound that is produced. In general, a good bass sound can be obtained by installing the subwoofer in a front corner, or at one-third the width of the wall, as shown.

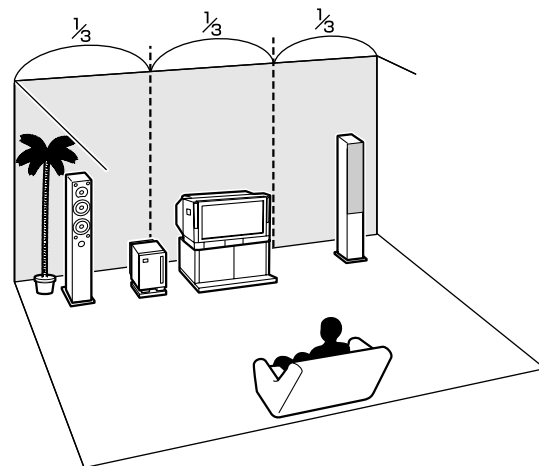

## Troubleshooting

### **The unit does not turn on**

- The power plug is not fully inserted.  
→ Insert the power plug fully into the power outlet.

### **No sound is output**

- The OUTPUT LEVEL knob is set to the MIN level.  
→ Set the OUTPUT LEVEL knob properly.
- Pin connector cable(s) are disconnected at the LINE INPUT jacks.  
→ Connect cable(s) to the LINE INPUT jacks.
- Speaker cables are not properly connected to the SPEAKER LEVEL INPUT terminals.  
→ Connect the speaker cables properly.
- The speaker setting at the amplifier (or receiver) is incorrect.  
→ Check the settings at the amplifier (or receiver).  
→ Slightly increase the output level at the amplifier (or receiver) (see page 5).
- The input signal is so small that the unit entered Standby mode.  
→ Turn the OUTPUT LEVEL knob until the Standby/On indicator light is green.

### **Low sound output**

- Speaker cables are connected to the SPEAKER LEVEL INPUT terminals with reversed phase.  
→ If cables are connected with reversed phase, L and R low-range signals will cancel each other, diminishing the low-range sound. Connect the speaker cables properly.
- The sound source might not include a superbass range.  
→ Play a sound source that includes a superbass range.

### **Hum noise**

- Pin connector cable is not inserted completely.  
→ Fully insert the pin connector cable.
- External leakage flux (induction noise by TV, etc.) occurs.  
→ Relocate the SL-107 away from the noise source and re-connect.

## Specifications

Type	Bass-reflex with built-in power amplifier
Use	For superbass-range reproduction
Frequency response	30–200 Hz (at maximum crossover frequency)
Crossover frequency	50–200 Hz (variable)
Maximum output power	150 W Dynamic
Input impedance	1.2 k $\Omega$ (for SPEAKER LEVEL INPUT terminals) 65 k $\Omega$ (for LINE INPUT jacks)
Sensitivity	
Speaker-Level	1.6 V
Line	230 mV
Speaker	20-cm woofer
Power supply	AC 220–230 V, 50/60 Hz
Power consumption	75 W
Dimensions (W × H × D)	230 × 435 × 401 mm
Weight	13.0 kg
Accessory	Pin connector cable (1 pc.) Cork spacers (4 pcs.) Instruction manual (this manual)
Others	Auto standby

Specifications and appearance are subject to change without prior notice.

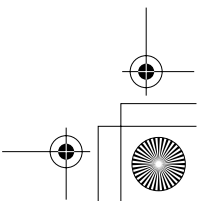
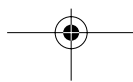
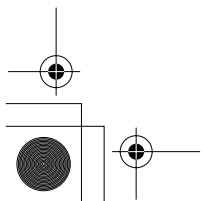
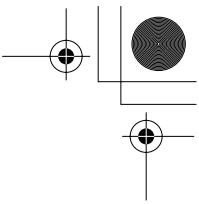
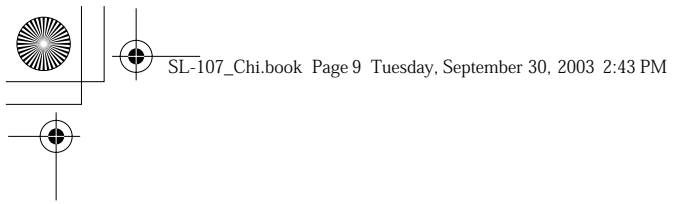

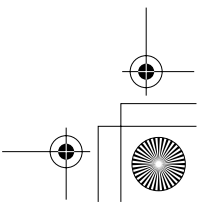
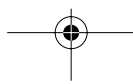
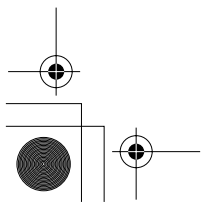
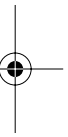
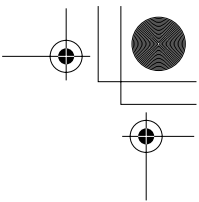
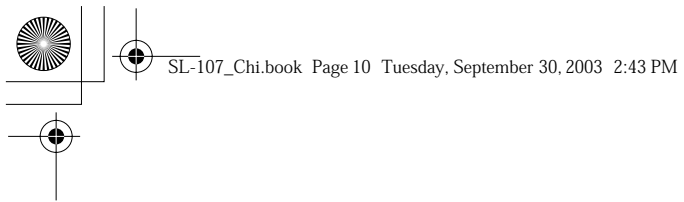

## **ONKYO CORPORATION**

Sales & Product Planning Div. : 2-1, Nisshin-cho, Neyagawa-shi, OSAKA 572-8540, JAPAN  
Tel: 072-831-8023 Fax: 072-831-8124

### **ONKYO U.S.A. CORPORATION**

18 Park Way, Upper Saddle River, N.J. 07458, U.S.A.  
Tel: 201-785-2600 Fax: 201-785-2650 <http://www.onkyousa.com>

### **ONKYO EUROPE ELECTRONICS GmbH**

Liegnitzerstrasse 6, 82194 Groebenzell, GERMANY  
Tel: +49-8142-4401-0 Fax: +49-8142-4401-555 <http://www.onkyo.net>

### **ONKYO CHINA LIMITED**

Units 2102-2107, Metroplaza Tower I, 223 Hing Fong Road, Kwai Chung,  
N.T., HONG KONG Tel: 852-2429-3118 Fax: 852-2428-9039



SN 29343607

(C) Copyright 2003 ONKYO CORPORATION Japan. All rights reserved.

I0310-1