

**Front speaker (SKF-770)**

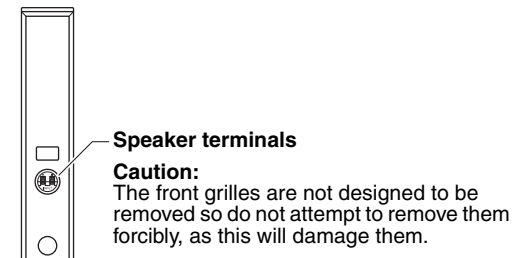
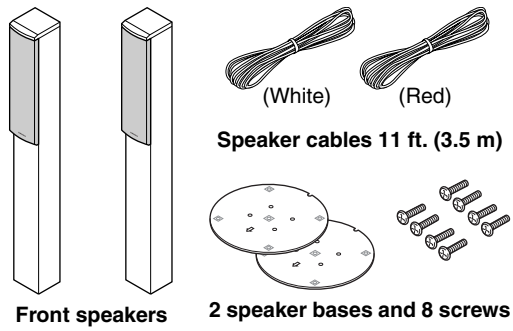

**Attaching the Speaker Bases**

Before you connect the speakers, attach the supplied speaker base to each SKF-770.

- Turn the speaker upside down with the protection cover attached.
- Align the speaker base while the arrow mark  $\uparrow$  is headed in the same direction as the speaker's face. Be careful not to tip over the speaker.
- Align the screw holes on the speaker base with those on the bottom of each speaker, and affix the speaker base using the supplied screws. Recommended torque is 10 kgf-cm (9 lbf-in). Be careful not to tip over the speaker.
- Turn the speaker right side up.
- Remove the protection cover.

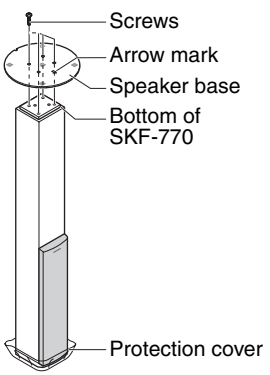

**SAFETY PRECAUTIONS:**

- Attach the speaker bases in a manner that will not allow the speakers to tip over.
- Be sure to tighten the screws when you attach the speaker bases.
- Attach the speaker bases on a flat, level, and stable floor.
- After you attach the speaker bases, make sure that the speakers stand upright and are stable.

**Center speaker (SKC-770)**

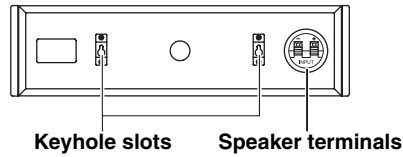
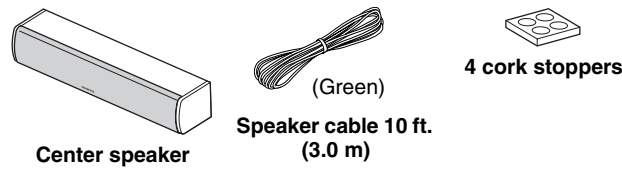

**Caution:** The front grilles are not designed to be removed so do not attempt to remove them forcibly, as this will damage them.

**Wall Mounting**

To mount the center speaker horizontally, use the two keyhole slots shown to hang each speaker on two screws that are securely screwed into the wall.

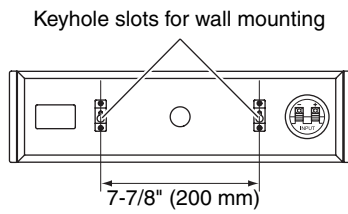

**Caution:** A mounting screw's ability to support a speaker depends on how well it's anchored to the wall. If you have hollow walls, screw each mounting screw into a stud. If there are no studs, or the walls are solid, use suitable wall anchors. Use screws with a head diameter of 5/16" (8 mm) or less and a shank diameter of 5/32" (4 mm) or less. With hollow walls, use a cable/pipe detector to check for any power cables or water pipes before making any holes. Leave a gap of between 7/32" (5 mm) and 3/8" (10 mm) between the wall and the base of the screw head, as shown. (We recommend that you consult a home installation professional.)

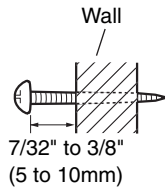

**Using the Cork Stoppers for a More Stable Platform**

We recommend using the supplied cork stoppers to achieve the best possible sound from your speakers. The cork stoppers prevent the speakers from moving, providing a more stable platform. Use stoppers for the center speaker.

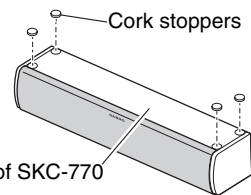

**Surround speaker (SKR-770)**

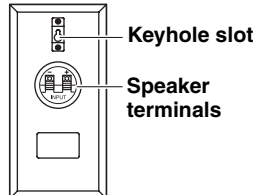
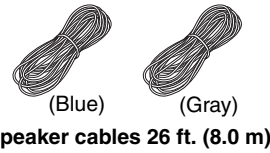
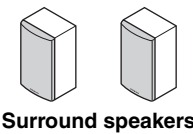

**Caution:** The front grilles are not designed to be removed so do not attempt to remove them forcibly, as this will damage them.

**Wall Mounting**

To mount the surround speakers vertically, use the keyhole slot shown to hang each speaker on a screw that's securely screwed into the wall.

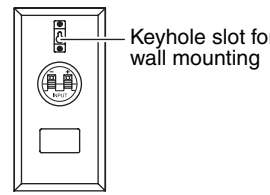

**Caution:** A mounting screw's ability to support a speaker depends on how well it's anchored to the wall. If you have hollow walls, screw each mounting screw into a stud. If there are no studs, or the walls are solid, use suitable wall anchors. Use screws with a head diameter of 5/16" (8 mm) or less and a shank diameter of 5/32" (4 mm) or less. With hollow walls, use a cable/pipe detector to check for any power cables or water pipes before making any holes. Leave a gap of between 7/32" (5 mm) and 3/8" (10 mm) between the wall and the base of the screw head, as shown. (We recommend that you consult a home installation professional.)

**Subwoofer (SKW-770)**

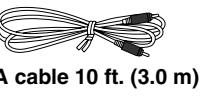
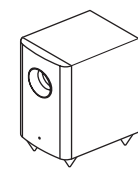

**Power-plug adapter**  
Only supplied in certain countries. Use this adapter if your AC outlet does not match with the plug on the subwoofer's power cord (adapter varies from country to country).

**\*How to mount the AC plug:**

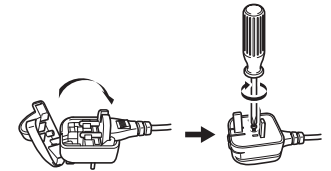

**Front**

**STANDBY/ON indicator**  
Red: Subwoofer in standby mode  
Blue: Subwoofer on  
With the Auto Standby function, the SKW-770 automatically turns on when an input signal is detected in Standby mode. When there's no input signal for a while, the SKW-770 automatically enters Standby mode.

**Rear**

**POWER switch**  
Press this switch to the ON position to turn on the power. Press it to the OFF position to turn off the power.  
**OUTPUT LEVEL control**  
This control is used to adjust the volume of the subwoofer.  
**LINE INPUT**  
This RCA input should be connected to the subwoofer pre out on your AV receiver with supplied RCA cable.  
**Note:** The Auto Standby function turns the subwoofer on when the input signal exceeds a certain level. If the Auto Standby function does not work reliably, try slightly increasing or decreasing the subwoofer output level on your receiver.

**Setting the Subwoofer Level**

To set the level of the subwoofer, use the OUTPUT LEVEL control. Set it so that bass sounds are evenly balanced with the treble sounds from the other speakers. Because our ears are less sensitive to very low bass sounds, there's a temptation to set the level of the subwoofer too high. As a rule of thumb, set the subwoofer level to what you think is the optimal level, and then back it off slightly.

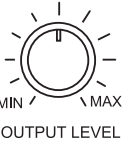

**Using the Floor Pads for Subwoofer**

If the subwoofer is placed on a hard floor (wood, vinyl, tile, etc.) and playback is very loud, the subwoofer's feet may damage the flooring. To prevent this, place the supplied pads underneath the subwoofer's feet. The pads also provide a stable base for the subwoofer.

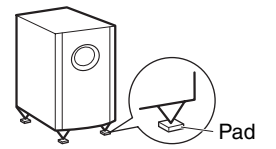

**Enjoying Home Theater**

The Home Theater means that you can enjoy surround sound with a real sense of movement in your own home — just like being in a movie theater or concert hall.

**Front left and right speakers (SKF-770)**

They should be positioned facing the listener at about ear level, and equally spaced from the TV. Angle them inward slightly so as to create a triangle, with the listener at the apex.

**Surround left and right speakers (SKR-770)**

Position them at the sides of the listener, or slightly behind, about 2 to 3 feet (60 to 100 cm) above ear level. Ideally they should be equally spaced from the listener.

**Center speaker (SKC-770)**

Position it close to your TV (preferably on top) facing forward at about ear level, or at the same height as the front left and right speakers.

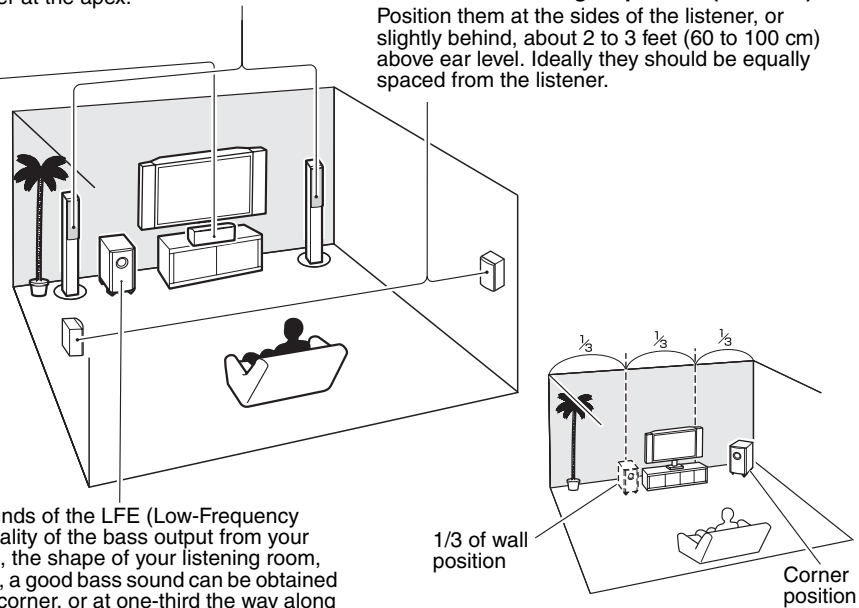

**Subwoofer (SKW-770)**

The subwoofer handles the bass sounds of the LFE (Low-Frequency Effects) channel. The volume and quality of the bass output from your subwoofer will depend on its position, the shape of your listening room, and your listening position. In general, a good bass sound can be obtained by installing the subwoofer in a front corner, or at one-third the way along the front wall, as shown.

**Connecting the Speakers**

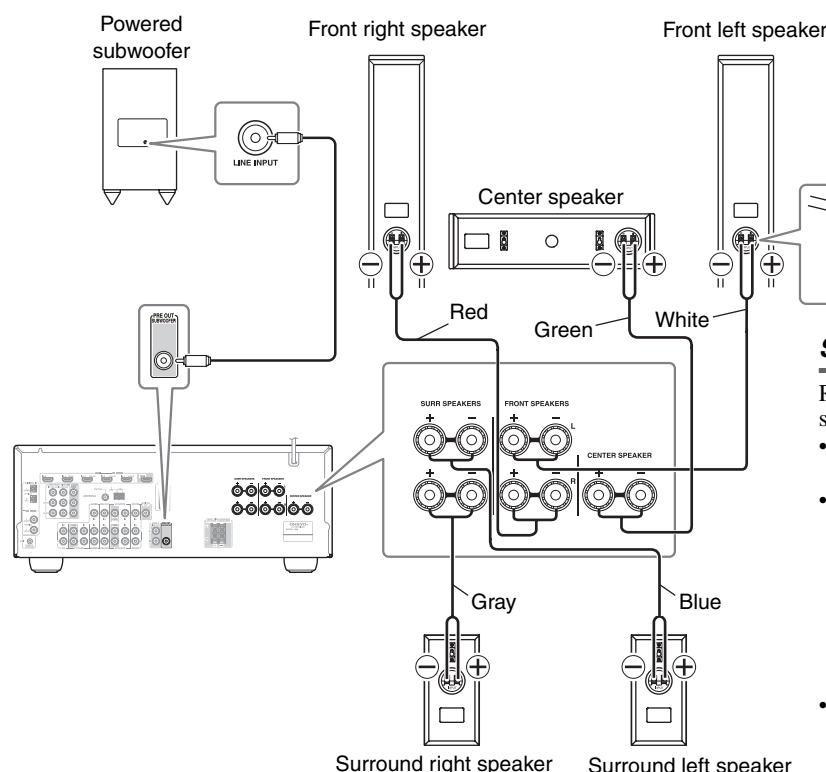

**Speaker Connection Precautions**

- Read the following before connecting your speakers:
- Turn off your receiver before making any connections.
  - Pay close attention to speaker wiring polarity. Connect positive (+) terminals to only positive (+) terminals, and negative (-) terminals to only negative (-) terminals. If the speakers are wired incorrectly, the sound will be out of phase and will sound unnatural.
  - Be careful not to short the positive and negative wires. Doing so may damage your amp.

**Specifications**

**Powered Subwoofer (SKW-770)**

Type: Bass-reflex  
Input sensitivity/impedance: 140 mV / 20 kΩ  
Maximum output power: 290 W (Dynamic Power)  
Frequency response: 25 Hz to 150 Hz  
Cabinet capacity: 37 L (1.3 cubic feet)  
Dimensions (W × H × D): 275 × 507 × 411 mm (10-13/16" × 19-15/16" × 16-3/16") (incl. projection)  
Weight: 11.6 kg (25.6 lbs.)  
Drivers unit: 25 cm (10") Cone Woofer × 1  
Power supply: AC 220 V – 240V, 50/60 Hz  
Power consumption: 137 W  
Other: Auto Standby function

**Front Speakers (SKF-770)**

Type: 2 Way Bass-reflex  
Impedance: 6 Ω  
Maximum input power: 130 W  
Sensitivity: 79.5 dB/W/m  
Frequency response: 55 Hz to 50 kHz  
Crossover frequency: 4 kHz  
Cabinet capacity: 7.3 L (0.26 cubic feet)  
Assembly dimensions (with supplied speaker base) (W × H × D): 262 × 1050 × 262 mm (10-5/16" × 41-5/16" × 10-5/16") (incl. projection)  
Weight: 5.2 kg (11.5 lbs.) (incl. speaker base)  
Drivers unit: 8 cm (3-1/4") cone (Woofer) × 2  
2.5 cm (1") Balanced dome (Tweeter)  
Terminal: Spring type color coded  
Grille: Fixed

**Center Speaker (SKC-770)**

Type: 2 Way Bass-reflex  
Impedance: 6 Ω  
Maximum input power: 130 W  
Sensitivity: 79 dB/W/m  
Frequency response: 60 Hz to 50 kHz  
Crossover frequency: 4 kHz  
Cabinet capacity: 2.8 L (0.10 cubic feet)  
Dimensions (W × H × D): 430 × 115 × 121 mm (16-15/16" × 4-1/2" × 4-3/4") (incl. grille and projection)  
Weight: 2.2 kg (4.9 lbs.)  
Drivers unit: 8 cm (3-1/4") Cone (Woofer) × 2  
2.5 cm (1") Balanced dome (Tweeter)  
Terminal: Spring type color coded  
Keyhole slot: 2  
Grille: Fixed

**Surround Speakers (SKR-770)**

Type: Full-range closed box  
Impedance: 6 Ω  
Maximum input power: 130 W  
Sensitivity: 81 dB/W/m  
Frequency response: 80 Hz to 20 kHz  
Cabinet capacity: 1.0 L (0.036 cubic feet)  
Dimensions (W × H × D): 115 × 230 × 96 mm (4-1/2" × 9-1/16" × 3-3/4") (incl. grille and projection)  
Weight: 1.0 kg (2.2 lbs.)  
Drivers unit: 8 cm (3-1/4") Cone  
Terminal: Spring type color coded  
Keyhole slot: 1  
Grille: Fixed

Specifications and appearance are subject to change without prior notice.

**ONKYO CORPORATION**

Sales & Product Planning Div. : 2-1, Nisshin-cho, Neyagawa-shi, OSAKA 572-8540, JAPAN  
Tel: 072-831-8023 Fax: 072-831-8163

**ONKYO U.S.A. CORPORATION**

18 Park Way, Upper Saddle River, N.J. 07458, U.S.A.  
Tel: 201-785-2600 Fax: 201-785-2650 <http://www.us.onkyo.com/>

**ONKYO EUROPE ELECTRONICS GmbH**

Liegnitzerstrasse 6, 82194 Groebenzell, GERMANY  
Tel: +49-8142-4401-0 Fax: +49-8142-4401-555 <http://www.eu.onkyo.com/>

**ONKYO EUROPE UK Office**

Suite 1, Gregories Court, Gregories Road, Beaconsfield, Buckinghamshire, HP9 1HQ  
UNITED KINGDOM Tel: +44-(0)1494-681515 Fax: +44(0)-1494-680452

**ONKYO CHINA LIMITED**

Unit 1&12, 9/F, Ever Gain Plaza Tower 1, 88, Container Port Road, Kwai Chung, N.T., HONG KONG Tel: 852-2429-3118 Fax: 852-2428-9039 <http://www.ch.onkyo.com/>

