

MiniDisc Recorder **MD-105TX**

Instruction Manual

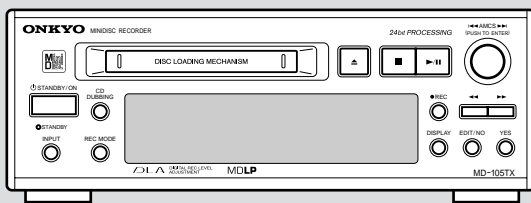

MDLP

Before using

Connections

Operations

Other Information

Before using

Thank you for purchasing ...

Thank you for purchasing the ONKYO MD-105TX MD Recorder.

Please read this manual thoroughly before making connections and plugging in the unit.

Following the instructions in this manual will enable you to obtain the optimum performance and listening enjoyment from your new MD-105TX.

Please retain this manual for future reference.

Main Features

- **Direct Digital Path**
- **4-Recording mode (MONO / SP / LP2 / LP4)**
- **32kHz / 44.1kHz / 48kHz Sampling Rate Converter**
- **24-Bit A/D and D/A Converters**
- **Digital Rec Level Adjustment**
- **Rec Volume Control for Analog and Digital Inputs**
- **Album Dubbing and Fade Out Control**
- **One-Touch Dubbing**
- **Signal Synchro Recording**

Memory Preservation

This unit does not require memory preservation batteries. A built-in memory power back-up system preserves the contents of the memory during power failures and even when the unit is unplugged. The unit must be plugged-in in order to charge the back-up system.

The memory preservation period after the unit has been unplugged varies depending on climate and placement of the unit. On the average, memory contents are protected over a period of a few weeks after the last time the unit was unplugged. This period is shorter when the unit is exposed to a highly humid climate.

Declaration of Conformity

We, ONKYO EUROPE
ELECTRONICS GmbH
INDUSTRIESTRASSE 20
82110 GERMERING,
GERMANY



declare in own responsibility, that the ONKYO product described in this instruction manual is in compliance with the corresponding technical standards such as EN60065, EN55013, EN55020 and EN61000-3-2, -3-3.

GERMERING, GERMANY

A. HORIUCHI

ONKYO EUROPE ELECTRONICS GmbH

U.S. and foreign patents licensed from Dolby Laboratories Licensing Corporation.

WARNING:

TO REDUCE THE RISK OF FIRE OR ELECTRIC SHOCK, DO NOT EXPOSE THIS APPLIANCE TO RAIN OR MOISTURE.



WARNING
RISK OF ELECTRIC SHOCK
DO NOT OPEN

AVIS
RISQUE DE CHOC ELECTRIQUE
NE PAS OUVRIR



CAUTION:

TO REDUCE THE RISK OF ELECTRIC SHOCK, DO NOT REMOVE COVER (OR BACK). NO USER-SERVICEABLE PARTS INSIDE. REFER SERVICING TO QUALIFIED SERVICE PERSONNEL.



The lightning flash with arrowhead symbol, within an equilateral triangle, is intended to alert the user to the presence of uninsulated "dangerous voltage" within the product's enclosure that may be of sufficient magnitude to constitute a risk of electric shock to persons.

The exclamation point within an equilateral triangle is intended to alert the user to the presence of important operating and maintenance (servicing) instructions in the literature accompanying the appliance.

Important Safeguards

- 1. Read Instructions** – All the safety and operating instructions should be read before the appliance is operated.
- 2. Retain Instructions** – The safety and operating instructions should be retained for future reference.
- 3. Heed Warnings** – All warnings on the appliance and in the operating instructions should be adhered to.
- 4. Follow Instructions** – All operating and use instructions should be followed.
- 5. Water and Moisture** – The appliance should not be used near water – for example, near a bathtub, washbowl, kitchen sink, laundry tub, in a wet basement, or near a swimming pool, and the like.
- 6. Carts and Stands** – The appliance should be used only with a cart or stand that is recommended by the manufacturer.
- 6A. An appliance and cart combination should be moved with care. Quick stops, excessive force, and uneven surfaces may cause the appliance and cart combination to overturn.

PORTABLE CART WARNING
S3125A
- 7. Wall or Ceiling Mounting** – The appliance should be mounted to a wall or ceiling only as recommended by the manufacturer.
- 8. Ventilation** – The appliance should be situated so that its location or position does not interfere with its proper ventilation. For example, the appliance should not be situated on a bed, sofa, rug, or similar surface that may block the ventilation openings; or if placed in a built-in installation, such as a bookcase or cabinet that may impede the flow of air through the ventilation openings, there should be free space of at least 5 cm (2 in.) and an opening behind the appliance.
- 9. Heat** – The appliance should be situated away from heat sources such as radiators, heat registers, stoves, or other appliances (including amplifiers) that produce heat.
- 10. Power Sources** – The appliance should be connected to a power supply only of the type described in the operating instructions or as marked on the appliance.
- 11. Polarization** – If the appliance is provided with a polarized plug having one blade wider than the other, please read the following information: The polarization of the plug is a safety feature. The polarized plug will only fit the outlet one way. If the plug does not fit fully into the outlet, try reversing it. If there is still trouble, the user should seek the services of a qualified electrician. Under no circumstances should the user attempt to defeat the polarization of the plug.
- 12. Power-Cord Protection** – Power-supply cords should be routed so that they are not likely to be walked on or pinched by items placed upon or against them, especially near plugs, convenience receptacles, and the point where they exit from the appliance.
- 13. Cleaning** – The appliance should be cleaned only as recommended by the manufacturer.
- 14. Nonuse Periods** – The power cord of the appliance should be unplugged from the outlet when left unused for a long period of time.
- 15. Object and Liquid Entry** – Care should be taken so that objects do not fall and liquids are not spilled into the enclosure through openings.
- 16. Damage Requiring Service** – The appliance should be serviced by qualified service personnel when:
 - A. The power-supply cord or the plug has been damaged; or
 - B. Objects have fallen, or liquid has been spilled into the appliance; or
 - C. The appliance has been exposed to rain; or
 - D. The appliance does not appear to operate normally or exhibits a marked change in performance; or
 - E. The appliance has been dropped, or the enclosure damaged.
- 17. Servicing** – The user should not attempt to service the appliance beyond that described in the operating instructions. All other servicing should be referred to qualified service personnel.

Precautions

1. Warranty Claim

You can find the serial number on the rear panel of this unit. In case of warranty claim, please report this number.

2. Recording Copyright

Recording of copyrighted material for other than personal use is illegal without permission of the copyright holder.

3. Power

WARNING

BEFORE PLUGGING IN THE UNIT FOR THE FIRST TIME, READ THE FOLLOWING SECTION CAREFULLY.

The voltage of the available power supply differs according to country or region. Be sure that the power supply voltage of the area where this unit will be used meets the required voltage (e.g., AC 230 V, 50 Hz or AC 120 V, 60 Hz) written on the rear panel.

Turning off the standby button does not shut off the power completely. So the power cord should be removed from the AC outlet when the unit is not used for a prolonged time.

4. Do not touch this unit with wet hands

Do not handle this unit or power cord when your hands are wet or damp. If water or any other liquid enters the case, take this unit to an authorized service center for inspection.

5. Location of this unit

Place this unit in a well-ventilated location.

Take special care to provide plenty of ventilation on all sides of this unit especially when it is placed in an audio rack. If ventilation is blocked, this unit may overheat and malfunction.

Do not expose this unit to direct sunlight or heating units as this unit's internal temperature may rise and shorten the life of the pickup.

Avoid damp and dusty places and places directly affected by vibrations from the speakers. In particular, avoid placing the unit on or above one of the speakers.

Be sure this unit is placed in a horizontal position. Never place it on its side or on a slanted surface as it may malfunction.

Do not place near tuners or TV sets.

If placed next to a TV or tuner, it may cause reception interference resulting in some noise in the TV or tuner output.

6. Care

From time to time you should wipe the front and rear panels and the cabinet with a soft cloth. For heavier dirt, dampen a soft cloth in a weak solution of mild detergent and water, wring it out dry, and wipe off the dirt. Following this, dry immediately with a clean cloth.

Do not use rough material, thinners, alcohol or other chemical solvents or cloths since these could damage the finish or remove the panel lettering.

7. Points to remember

If this unit is brought from a cold environment to a warm one or is in a cold room that is quickly heated, condensation may form on the pickup, preventing proper operation. In this case, remove the disc and leave the power ON for about one hour to remove the condensation.

When transporting this unit, be careful not to bump it.

DANGER:

INVISIBLE LASER RADIATION WHEN OPEN AND INTERLOCK FAILED OR DEFEATED. AVOID DIRECT EXPOSURE TO BEAM.

CAUTION:

THIS PRODUCT UTILIZES A LASER. USE OF CONTROLS OR ADJUSTMENTS OR PERFORMANCE OF PROCEDURES OTHER THAN THOSE SPECIFIED HEREIN MAY RESULT IN HAZARDOUS RADIATION EXPOSURE.

Precautions(continued)

For U.S. model

The laser is covered by a housing which prevents exposure during operation or maintenance. However, this product is classified as a Laser Product by CDRH (Center for Devices and Radiological Health) which is a department of the Food and Drug Administration. According to their regulations 21 CFR section 1002.30, all manufactures who sell Laser Products must maintain records of written communications between the manufacturer, dealers and customers concerning radiation safety. If you have any complaints about instructions or explanations affecting the use of this product, please feel free to write to the address on the back page of this manual. When you write us, please include the model number and serial number of your unit.

In compliance with Federal Regulations, the certification, identification and the period of manufacture are indicated on the rear panel.

FCC INFORMATION FOR USER

CAUTION:

The user changes or modifications not expressly approved by the party responsible for compliance could void the user's authority to operate the equipment.

NOTE:

This equipment has been tested and found to comply with the limits for a Class B digital device, pursuant to Part 15 of the FCC Rules. These limits are designed to provide reasonable protection against harmful interference in a residential installation. This equipment generates, uses and can radiate radio frequency energy and, if not installed and used in accordance with the instructions, may cause harmful interference to radio communications. However, there is no guarantee that interference will not occur in a particular installation. If this equipment does cause harmful interference to radio or television reception, which can be determined by turning the equipment off and on, the user is encouraged to try to correct the interference by one or more of the following measures:

- Reorient or relocate the receiving antenna.

- Increase the separation between the equipment and receiver.
- Connect the equipment into an outlet on a circuit different from that to which the receiver is connected.
- Consult the dealer or an experienced radio/TV technician for help.

Precautions(continued)

For Canadian model

NOTE:

THIS CLASS B DIGITAL APPARATUS COMPLIES WITH CANADIAN ICES-003.

For models having a power cord with a polarized plug:

CAUTION: TO PREVENT ELECTRIC SHOCK, MATCH WIDE BLADE OF PLUG TO WIDE SLOT, FULLY INSERT.

Modele pour les Canadien

REMARQUE:

CET APPAREIL NUMÉRIQUE DE LA CLASSE B EST CONFORME À LA NORME NMB-003 DU CANADA.

Sur les modèles dont la fiche est polarisée:

ATTENTION: POUR ÉVITER LES CHOCS ÉLECTRIQUES, INTRODUIRE LA LAME LA PLUS LARGE DE LA FICHE DANS LA BORNE CORRESPONDANTE DE LA PRISE ET POUSSER JUSQU'AU FOND.

For European model

This unit contains a semiconductor laser system and is classified as a "CLASS 1 LASER PRODUCT". So, to use this model properly, read this Instruction Manual carefully. In case of any trouble, please contact the store where you purchased the unit. To prevent being exposed to the laser beam, do not try to open the enclosure.



This label on the left hand panel states that:

1. This unit is a CLASS 1 LASER PRODUCT and employs a laser inside the cabinet.
2. To prevent the laser from being exposed, do not remove the cover. Refer servicing to qualified personnel.

For British model

Replacement and mounting of an AC plug on the power supply cord of this unit should be performed only by qualified service personnel.

IMPORTANT

The wires in the mains lead are coloured in accordance with the following code:

Blue : Neutral

Brown : Live

As the colours of the wires in the mains lead of this apparatus may not correspond with the coloured markings identifying the terminals in your plug, proceed as follows:

The wire which is coloured blue must be connected to the terminal which is marked with the letter N or coloured black.

The wire which is coloured brown must be connected to the terminal which is marked with the letter L or coloured red.

IMPORTANT

A 5 ampere fuse is fitted in this plug. Should the fuse need to be replaced, please ensure that the replacement fuse has a rating of 5 amperes and that it is approved by ASTA or BSI to BS1362. Check for the ASTA mark or the BSI mark on the body of the fuse.

IF THE FITTED MOULDED PLUG IS UNSUITABLE FOR THE SOCKET OUTLET IN YOUR HOME, THEN THE FUSE SHOULD BE REMOVED AND THE PLUG CUT OFF AND DISPOSED OF SAFELY. THERE IS A DANGER OF SEVERE ELECTRICAL SHOCK IF THE CUT OFF PLUG IS INSERTED INTO ANY 13 AMPERE SOCKET.

If in any doubt, please consult a qualified electrician.

Table of contents

Before using

Supplied accessories	below
Using the remote controller	8

Connections

Connecting to the Onkyo Separate Collection series components	9
Connecting to the other components	10

Operations

Normal play	13
Random play	17
Repeat play	18
Memory play	19
Auto Space function	20
CD-dubbing (System operation)	21
Recording	24
Signal Synchro recording	30
System operation	31
Other information for recording	34
Editing the contents of an MD	35
Naming a track or disc	40

Other Information

Message list	43
System limitations	44
Rules for digital recording	45
Troubleshooting	46
Precautions for handling the MiniDisc (MD)	48
Indexed to parts and controls	49
Specifications	52

Supplied accessories

Check that the following accessories are supplied with this unit.

- **RI remote control cable x1**
- **Audio connection cable x2**
- **Optical fiber cable x1**

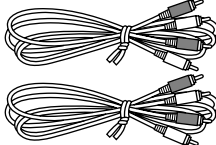

- **Remote controller x1**
RC-409MD

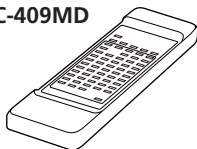

- **Dry batteries UM-3 x2**



Using the remote controller

Inserting the remote controller batteries

- 1 Remove the battery compartment cover by opening it as shown in the illustration.

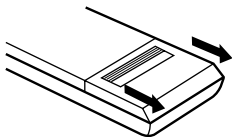

- 2 Insert two AA (R6 or UM-3)-size batteries into the battery compartment.

Carefully follow the polarity diagram (positive(+)) and negative (-) symbols inside the battery compartment.

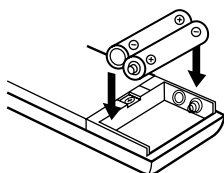

- 3 Replace the compartment cover.

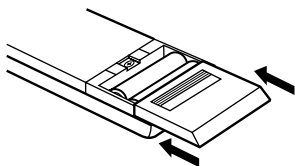

Notes

- Do not mix new batteries with old batteries or different kinds of batteries.
- To avoid corrosion, remove the batteries if the remote controller is not to be used for a long period of time.
- Remove dead batteries immediately to avoid damage from corrosion. If the remote controller doesn't operate smoothly, replace both batteries at the same time.
- The life of the batteries supplied is about six months, but will vary depending on usage.

Using the remote controller

Point the remote controller toward the remote control sensor.

With the supplied remote controller (RC-409MD)

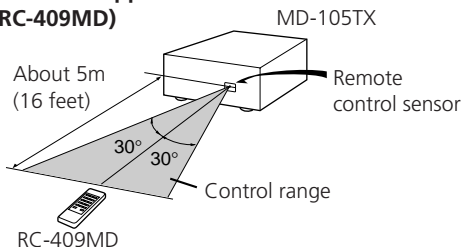

Remote controller RC-456S

When you use the remote controller RC-456S supplied with the amplifier A-905TX/R-805TX, operate the remote controller by pointing it towards the amplifier's remote sensor.

Be sure to make the **RI** connection securely. If the connection is incomplete, you will be unable to use the remote controller to operate the unit.

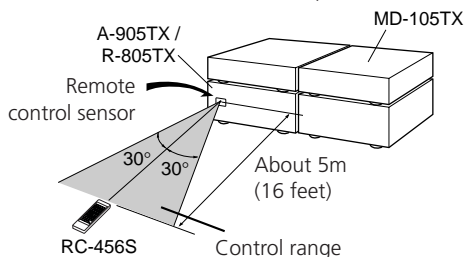

Notes

- Locate the unit away from strong light, such as direct sunlight or inverted fluorescent light, which can prevent proper operation of the remote controller.
- Using another remote controller of the same type in the same room or using the unit near equipment that uses infrared rays may cause operational interference.
- Do not put any object (such as a book) on the remote controller. The buttons of the remote controller may be pressed accidentally and drain the batteries.
- Make sure the audio rack doors do not have colored or tinted glass. Placing the unit behind such doors may prevent proper remote controller operation.
- If there is any obstacle between the remote controller and the remote control sensor, the remote controller will not operate.

Connecting to the Onkyo Separate Collection series components

This section introduces you to the other Separate Collection Series system components and their convenient system functions. Connection instructions follow.

The following Separate Collection series components are commercially available:

- T-405TX Stereo Tuner
- A-905TX Integrated Stereo Amplifier
- K-505TX Stereo Cassette Tape Deck
- C-705TX Compact Disc (CD) Player (not available in U.S.A and Canada)
- C-707CHX Compact Disc (CD) Changer (only available in U.S.A. and Canada)
- R-805TX FM Stereo/AM Tuner Amplifier
- CDR-205TX Audio CD Recorder

Note that the available components may vary according to the area.

Using the unit in conjunction with the above system components enables you to operate the following convenient functions.

• Auto Power On

- You can turn on the power to the amplifier by pressing the STANDBY/ON button on one of the system components. (The amplifier's POWER switch must be set to ON.)
- When the amplifier's POWER switch is set to ON, you can turn on the power to all the system components simultaneously by pressing the STANDBY/ON button on the amplifier.

Afterwards, you can turn off the power to the individual components that are not in use.

Note: If an R-805TX has been connected to the system and the R-805TX's energy save function has been enabled, pressing the STANDBY/ON button of the MD-105TX will not turn on the power to the MD-105TX. You need to press the STANDBY/ON button on the R-805TX. (Refer to the instruction manual for the R-805TX for more information.)

• Direct Change

Pressing the ►/■ button of the MD-105TX automatically selects the "MD" input source on the A-905TX before the MD-105TX starts playing.

• Remote control of the System Components

You can control the operation of this MD recorder using the A-905TX/R-805TX's remote controller.

• Program Timer

You can record the desired broadcasting programs or play your favorite MD at a specified time using the T-405TX/R-805TX's built-in timer. (Refer to the T-405TX/R-805TX instruction manual for more information.)

• Sleep Timer

You can fall asleep to a music/radio program with the timer. (Refer to the T-405TX/R-805TX instruction manual for more information.)

• CD-dubbing

You can start recording from a CD player to your MD-105TX by pressing the CD DUBBING button.

• CD-synchro Recording

When this function is enabled, you can immediately start recording to the MD by pressing the ► button on the CD player. (Refer to page 31 for more information.)

• Cassette-synchro Recording

When this function is enabled, you can start recording to the MD by pressing the ► button on the cassette deck. (Refer to page 32 for more information.)

Connecting to the other components

Before connecting

- Do not connect the unit's AC power cord to a wall outlet until you have completed all the other connections.
- On each pair of connectors, a red connector (marked R) corresponds to the right channel, and a white connector (marked L) to the left channel. Connect the white plugs of audio connection cables to L connectors; connect the red plugs of audio connection cables to R connectors.

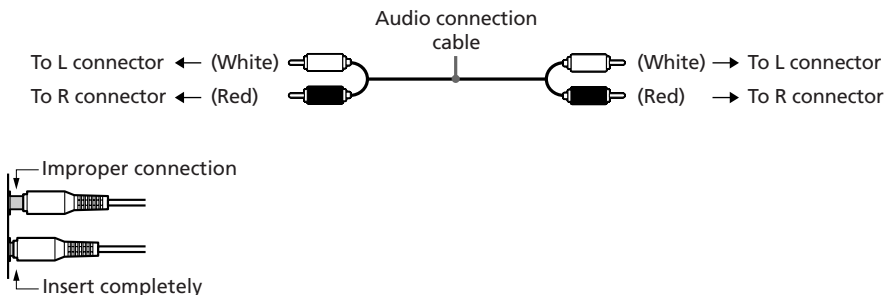

- Insert the plug securely. If the connection is incomplete, noise or malfunction may result.
- When you use a digital audio optical cable, do not bend it sharply or coil it tightly.
- Bundling an audio connection cable with the power cord or speaker cord may degrade the sound quality.
- To use the unit with the other Onkyo Separate Collection series components, follow the connection diagram in the A-905TX/R-805TX instruction manual to connect the unit to the system.

Note:

The 230-240 V model is shown in the following illustrations.

Connecting to the other components (continued)

- This unit uses heat-sensitive parts. Do not place this unit on the Amplifier or Receiver.

Connections

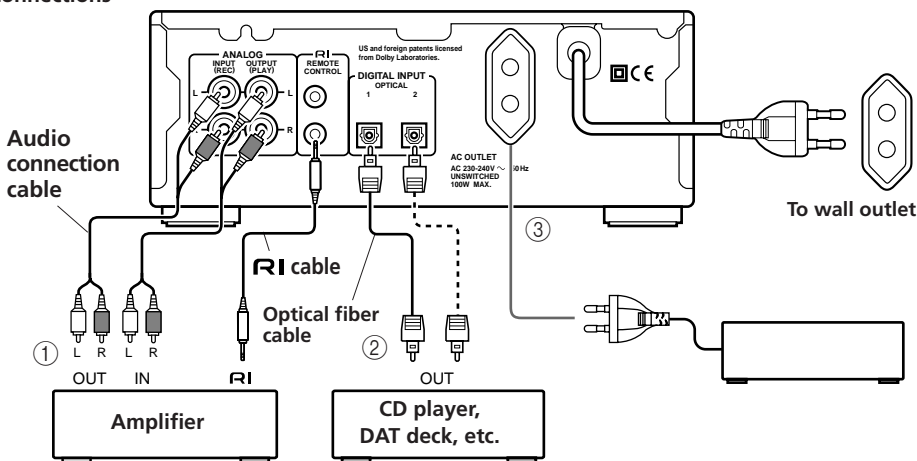

① Connecting to the Amplifier

Connect the MD-105TX to the MD (or TAPE) jacks of your amplifier.

② Connecting to the Digital Input Terminals (DIGITAL INPUT 1, 2)

You can perform digital recording on the MD-105TX if a CD (Compact Disc) player or DAT (Digital Audio Tape) deck equipped with a digital (OPTICAL) output terminal is available. For digital recording, you need to connect the equipment to either DIGITAL INPUT 1 or 2 terminal using the supplied optical cable. These terminals can also be used for connecting an amplifier that is equipped with a digital output terminal.

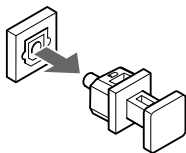

Note

- If you use DIGITAL INPUT 2 to connect an amplifier, you will be unable to utilize the full capabilities of the MD-105TX.
- If you attempt to perform digital recording using a digital input terminal that is not connected, "D.In Unlock" will appear.

- Terminal protection caps are attached to the DIGITAL INPUT terminals. Remove the cap for the terminal you wish to use when connecting the MD-105TX to digital equipment. Replace the caps if you are not using the DIGITAL INPUT terminals.

③ Connection to AC outlet (UNSWITCHED)

The power cord of another unit can be connected to this outlet.

Note

The shape, number, and total capacity of the AC outlets may differ depending on the area in which the unit is purchased.

230-240 V, 50 Hz model: Capacity is 100 W in total.

120 V, 60 Hz model: Capacity is 120 W in total.

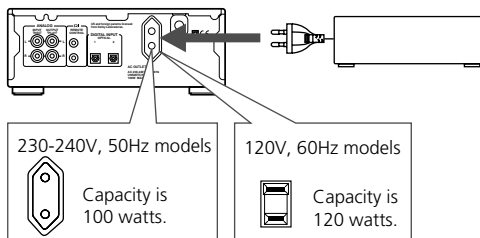

Connecting to the other components (continued)

Connecting the (RI) controller

If you are using other ONKYO components equipped with **RI** connectors, you can control these components using the amplifier's remote controller.

Before connecting

- The amplifier must be connected to the **RI** system hookups for **RI** control operation.
- Each component has two **RI** connectors. There is no difference between these connectors.
- The components may be connected in any order.
- Remote control operation is not possible if only the **RI** remote control cable is connected to the **RI** connectors. Connect the audio connection cables correctly.

The illustration below is an **RI** hookup example. With these hookups, you can operate the CD Synchro Recording (see "CD/MD synchro recording" on page 9).

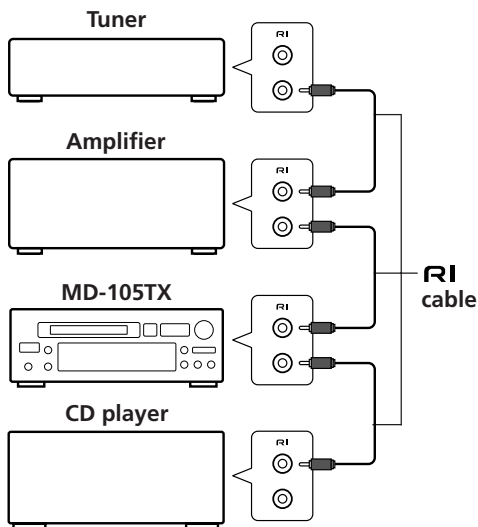

Note

An **RI** remote control cable equipped with a 1/8 in. (3.5mm) diameter miniature two-conductor phone plug is included with this unit and with every tuner and cassette deck that bears the **RI** mark.

Connecting the AC power cord (mains lead)

Insert the AC power cord into a wall outlet. The **STANDBY** indicator lights.

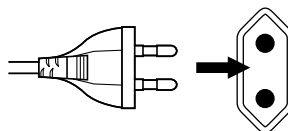

⊖ STANDBY/ON

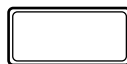

⊖ STANDBY

- To use the unit with the other Onkyo Separate Collection series components, follow the connection diagram in the A-905TX/R-805TX instruction manual to connect the unit to the system.
- If you press the EJECT button while the unit is in **STANDBY** mode, the power will turn on and the display will light up automatically.

Operations

Normal play

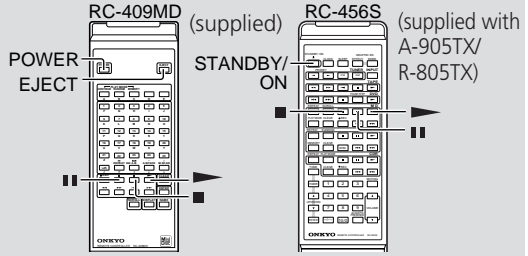
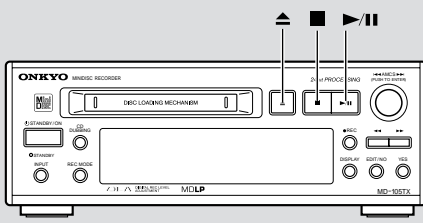

1 Press the STANDBY/ON button. (or the POWER button on the remote controller)

The STANDBY indicator goes out.

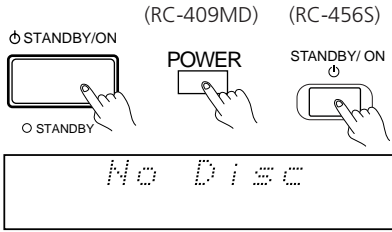

2 Insert an MD.

The MD recorder reads TOC (Table Of Contents) information on the MD to display the total number of tracks and total playing time.

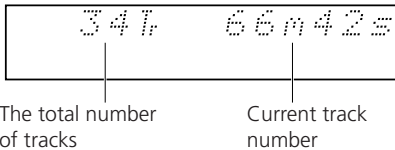
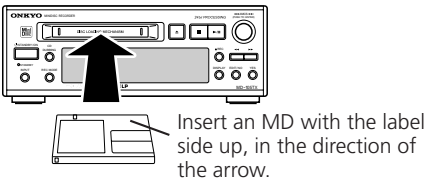

- When an MD recorded with a disc name is inserted, the disc name is displayed. If the disc name is too long and you cannot view the entire name, press the SCROLL button on your remote controller to shift the display.

3 Press the ►/|| button (or the ► button on the remote controller).

The first track of the disc starts playing.

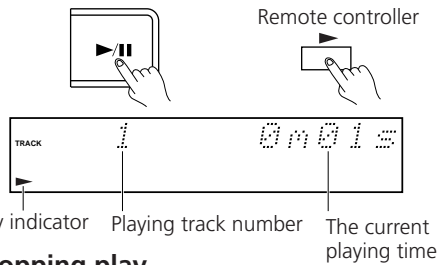

Stopping play

Press the ■ button (or the ■ button on the remote controller).

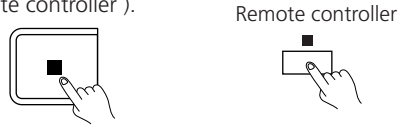

Stopping play temporarily

Press the ►/|| button (or the || button on the remote controller). The Pause indicator lights up.

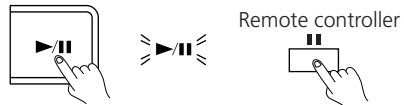

To resume play, press the ►/|| button (or the ► button on the remote controller).

Ejecting the MD

Press the ▲ button (or the EJECT button on the remote controller).

The MD is ejected and "Eject" is shown on the display.

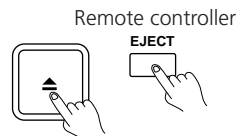

Normal play (continued)

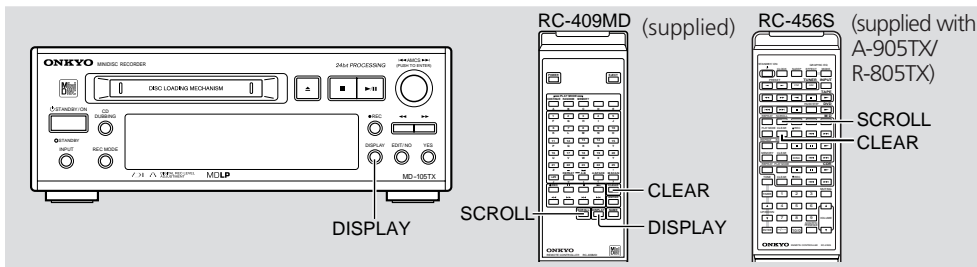

Changing the display mode

When the MD recorder is stopped

Pressing the DISPLAY button changes the display in the following sequence:

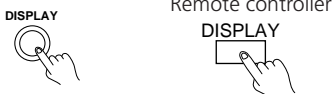

Total number of tracks on the MD and its total playing time

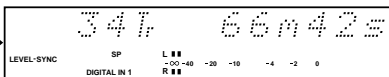

Time remaining for recording on the MD (Not displayed if it is a premastered MD)

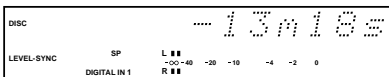

Disc name ("No Name" when not set)

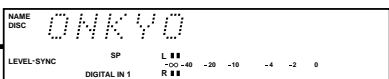

When an MD is playing or pausing

Pressing the DISPLAY button changes the display in the following sequence:

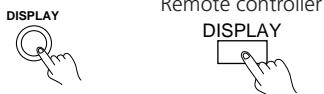

Playing track number and elapsed playing time

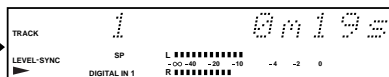

Playing track number and remaining playing time

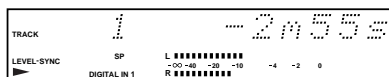

Track name (Track number with "No Name" when not set)

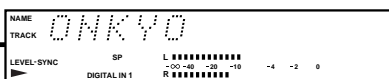

If the track name is too long to display

You can scroll the track name by pressing the SCROLL button on the remote controller.

Press the SCROLL button when the track name is scrolling to stop the scrolling of the track name; press the SCROLL button again to resume the scrolling of the track name.

To exit the display scroll mode, press the CLEAR button on the remote controller.

Normal play (continued)

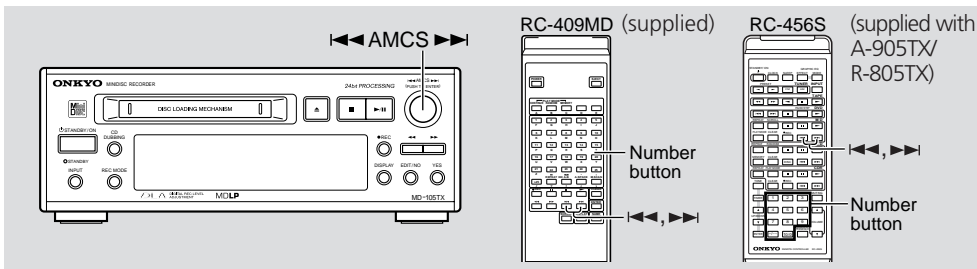

Selecting the track to play using the number buttons

Press the number button on the remote controller to select the track you want to play.

(RC-409MD)

(RC-456S)

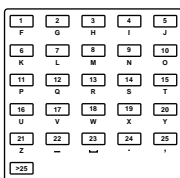

To select a track numbered 26 or above using RC-409MD

Press the [>25] button first. Set a value for the 10th place and then the 1st place using the number buttons in this order. (Enter "0" by pressing the [10] button.)

Ex. To select the 30th track:

[>25] + [3] + [10]

To select the 100th track:

[>25] + [>25] + [1] + [10] + [10]

To select a track numbered 11 or above using RC-456S

Press the [--/--] button first. Set a value for the 10th place and then the 1st place using the number buttons in the following order. (Enter "0" by pressing the [10/0] button.)

Ex. To select the 30th track:

[--/--] + [3] + [10/0]

To select the 100th track:

[--/--] + [--/--] + [1] + [10/0] + [10/0]

Changing the playing track using the AMCS

During play, you can change the track that is playing by turning the AMCS knob (or by pressing the \lll or \ggg buttons on the remote controller).

If the MD recorder is stopped, turn the AMCS knob to select the track number you wish to play, and press that knob (with the remote controller, use the \lll or \ggg button to select the track, then press the \ggg button.)

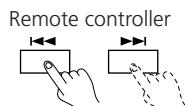
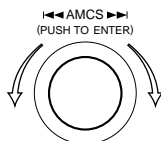

To play the next track or a later track

Turn the AMCS knob clockwise (or press the \ggg button on the remote controller several times) until the desired track is located.

To start play again from the beginning of the track that is currently playing or to play the previous track or an earlier track

Turn the AMCS knob counterclockwise (or press the \lll button on the remote controller several times) until the desired track is located.

In Memory play mode (see page 19), turning the AMCS knob (or pressing the \ggg or \lll button) selects the track in the stored sequence.

Normal play (continued)

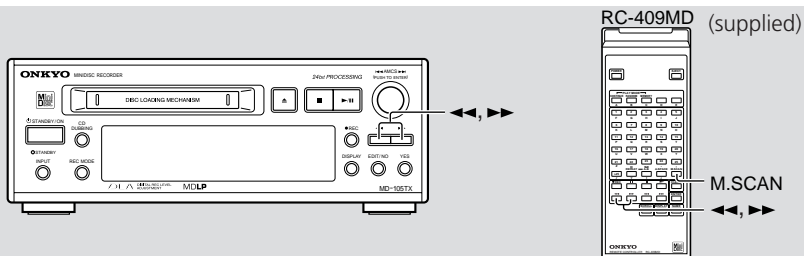

Music Scan

The following operation is possible only when using the supplied remote controller (RC-409MD).

Pressing the M.SCAN button plays the beginning (eight seconds) of each track on the disc in sequence whether the MD recorder is either playing or stopped.

- The “M.SCAN” indicator lights up.
- You can press the ► or M.SCAN button on the remote controller when the beginning of the desired track is playing to start playing from that track.

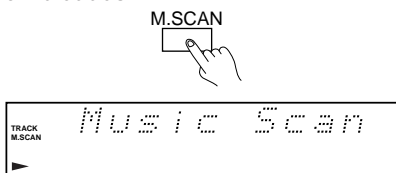

Searching for a part to play (Search play)

Searching for a part to play by sound (at play)

During play, hold down the ◀◀ or ▶▶ button and release it when the part you want to hear is playing.

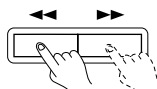

Searching for a part to play by using displayed time (at pause, high-speed search)

When playing is temporarily stopped (paused), keep pressing the ◀◀ or ▶▶ button and release it when the playing time of the part you want to hear is displayed.

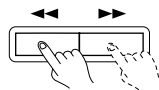

- Press the ►/||| button (or the ► button on the remote controller) to start playing from that part.
- “Over” in the display indicates that the end of the last track has been reached.

Random play

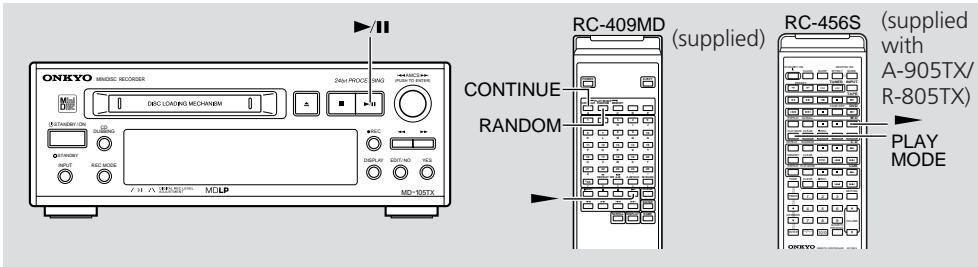

The following operation is possible only when using either of the following remote controllers:
RC-409MD (supplied)
RC-456S (supplied with the A-905TX/R-805TX amplifier)

1 When the MD recorder is stopped, press the **RANDOM** button (RC-409MD).

With the RC-456S remote controller, press the PLAY MODE button until "RANDOM" appears on the display.

(RC-409MD)



(RC-456S)



RANDOM

2 Press the ►/|| button (or the ► button on the remote controller).

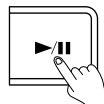

Remote controller



To exit the Random play mode

When the MD recorder is stopped, press the RANDOM button or CONTINUE button (RC-409MD).

With the RC-456S remote controller, press the PLAY MODE button until "RANDOM" or "MEMORY" disappears from the display.

Note

You can also use the Eject button or STANDBY/ON button to exit Random play mode.

Repeat play

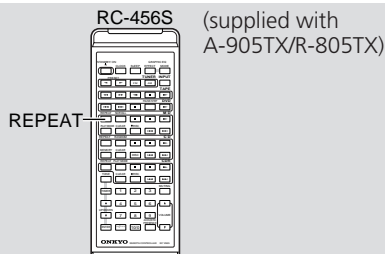
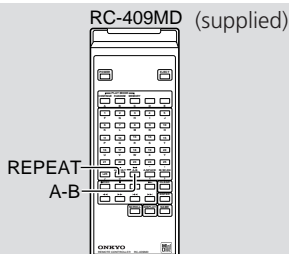

The following operation is possible using either of the following remote controllers:

RC-409MD (supplied)

RC-456S (supplied with the A-905TX/R-805TX amplifier)

The following operation is possible only when you use the supplied remote controller (RC-409MD).

Repeatedly playing all tracks of an MD

Press the REPEAT button on the remote controller just once.

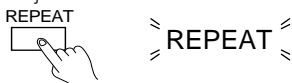

Repeatedly playing a single track

When the desired track is playing, press the REPEAT button on the remote controller twice.

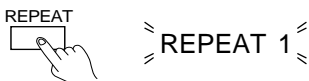

- **If the REPEAT button is pressed during Memory play...**
Only the programmed tracks play repeatedly in the programmed order.
- **If the REPEAT button is pressed during Random play...**
The contents of the entire MD play again repeatedly. The playing order changes each time a random play begins.

Note

In Memory play or Random play, you cannot repeat the currently playing track (REPEAT 1).

To stop the Repeat play

Press the REPEAT button once or twice until the "REPEAT" indicator disappears.

Note

You can also use the Eject button or STANDBY/ON button to stop the repeat of all tracks or a single track.

Repeatedly playing a section of a track (A-B Repeat) (RC-409MD only)

- 1 While the track is playing, specify the beginning of the section you wish to repeat playing by pressing the A-B button on the remote controller (Point A).**

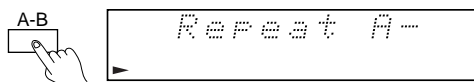

- 2 While the track is still playing, specify the end of the section by pressing the A-B button on the remote controller (Point B) a second time.**

Section A to B of the track will be repeated.

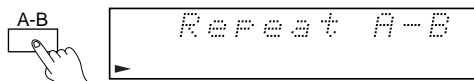

To stop A-B Repeat

- Press the A-B or REPEAT button when a section is in Repeat play.
The A-B Repeat mode is now canceled.
- Press the ■ button when a section is in Repeat play.
The A-B Repeat mode is canceled and play of the current track stops.

Note

A-B Repeat cannot be used when the unit is in Repeat (all-track or single-track), Memory, or Random play.

Memory play

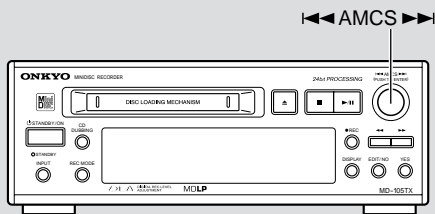

RC-409MD (supplied)

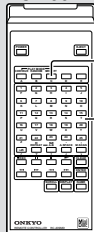

MEMORY

Number button

RC-456S (supplied with A-905TX/R-805TX)

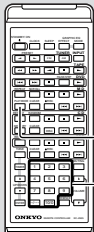

PLAY MODE

Number button

- Using the Memory function, you can select your favorite tracks (up to 25 tracks) on an MD and arrange them in the desired order.

1 When the MD recorder is stopped, press the MEMORY button (RC-409MD).

With the RC-456S remote controller, press the PLAY MODE button until "MEMORY" appears on the display.

(RC-409MD) (RC-456S)

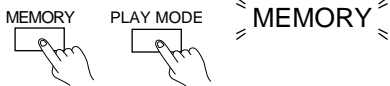

Selecting a track using the remote controller

(RC-409MD)

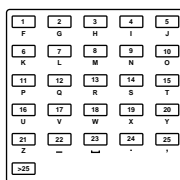

(RC-456S)

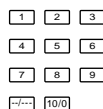

To select a track numbered 26 or above using the RC-409MD

Press the [>25] button first. Set a value for the 10th place and then the 1st place using the number buttons in the following order. (Enter "0" by pressing the [10] button.)

Ex.

To select the 30th track

[>25] + [3] + [10]

To select the 100th track

[>25] + [>25] + [1] + [10] + [10]

To select a track numbered 11 or above using the RC-456S

Press the [--/--] button first. Set a value for the 10th place and then the 1st place using the number buttons in this order. (Enter "0" by pressing the [10/0] button.)

Ex.

To select the 30th track:

[--/--] + [3] + [10/0]

To select the 100th track:

[--/--] + [--/--] + [1] + [10/0] + [10/0]

2 Using the AMCS knob, select the tracks in the order you want to play.

Turn the AMCS knob until the track number you want to store is displayed (the playing time of the track is displayed). Then, press the AMCS knob to store the track.

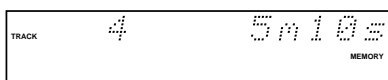
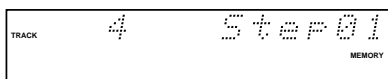
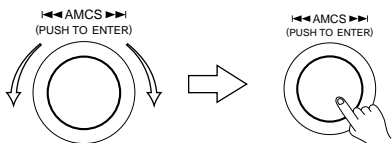

(Continued on the next page)

Memory play (continued) / Auto Space function

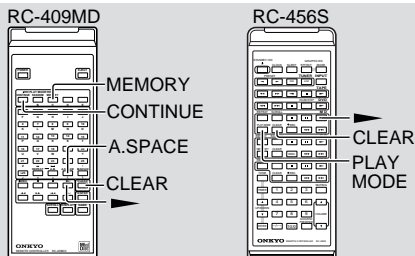
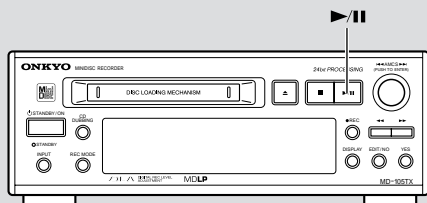

Note

If the total playing time of the programmed tracks exceeds 512 minutes, “---m--s” will be displayed.

3 Press the ▶/|| button (or the ▶ button on the remote controller) to start Memory play.

When all stored tracks have been played, the MD recorder stops, retaining the stored tracks in memory.

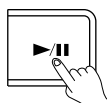

Remote controller



To exit Memory play mode

When the MD recorder is stopped, press the CONTINUE button on the remote controller (RC-409MD).

With the RC-456S remote controller, press the PLAY MODE button until “MEMORY” disappears from the display.

Clearing the last track stored

Press the CLEAR or ■ button on the remote controller.

The last track in memory is cleared.

Checking the stored contents

To check the tracks stored in memory, press the ◀◀/▶▶ button when the MD recorder is stopped.

Note

You can also use the Eject button or STANDBY/ON button to exit Memory Play mode.

Using the Auto Space function (RC-409MD only)

It is possible to play back the MD with a silent interval of approximately 3 seconds between tracks.

Turning on the Auto Space function

Press the A.SPACE button while the MD-105TX is playing, stopped, or paused.

The A.SPACE indicator lights up.

Note:

- If the Auto Space function is turned on, the display indicates “Auto Space” for three seconds during the interval between tracks.

(RC-409MD)

A.SPECE



A.SPACE

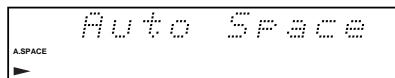

Cancelling the Auto Space function

Press the A.SPACE button again to cancel the function. The A.SPACE indicator turns off and the function is cancelled.

You can also use the Eject button or STANDBY/ON button to cancel the Auto Space function.

CD-dubbing (System operation)

CD-dubbing (System operation)

Setting the CD dubbing mode

The MD-105TX provides two CD dubbing modes: Album dubbing and Fade Out dubbing. These modes are applied only to CD dubbing, but not to other operations, such as signal synchro recording.

Album dubbing: If the end of the recordable area on the disc is reached before the track ends, the track will be discarded. If only one track is being dubbed, the track will not be discarded even if it was not recorded to the end.

Fade Out dubbing: If the end of the recordable area on the disc is reached before the track ends, the last portion of the recorded track will fade out.

The CD dubbing mode setting is possible only when the MD recorder is stopped.

- When your MD-105TX is configured into a system with Onkyo Separate Collection series components (A-905TX and C-705TX), you can record via CD dubbing by pressing the CD DUBBING button on the MD-105TX.
- To perform CD dubbing, your CD player must be connected through an optical cable to the DIGITAL INPUT 1 terminal located on the rear panel of the MD recorder. (Refer to the A-905TX/R-805TX instruction manual for more information.)
- For the normal recording procedure, see "Analog Recording" on page 24 or "Digital Recording" on page 27.

Note

- CD-dubbing is not available with the A-905, C-705 and C-707CH.
- When "Protected" is shown in the display, it indicates that the record-protect tab of the MD is open. Before starting the recording procedure, close the tab. (See page 34.)

1 Load the CD in the CD player.

See the C-705TX CD player instruction manual for information on loading CDs.

2 Load a recordable MD in the MD-105TX.

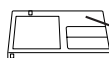

Insert an MD with the label side up, in the direction of the arrow.

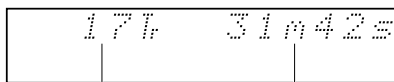

Number of recorded tracks on MD

Total recorded time

To check the time remaining for recording...

When the MD recorder is stopped, pressing the DISPLAY button changes the display as follows.

The number of tracks on MD and its total recorded time



Remaining recording time on MD



Disc name ("No Name" when not set)

To delete recorded data on the disc to make new recordings...

First delete all data on the disc, then start recording. (See page 36.)

CD-dubbing (System operation)

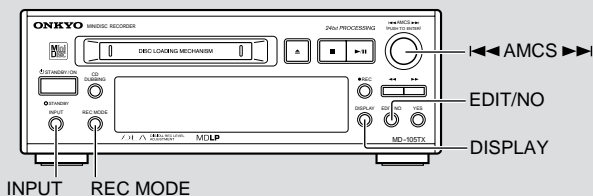

3 Select "Digital In 1."

Press the INPUT button repeatedly until "Digital In 1" appears.

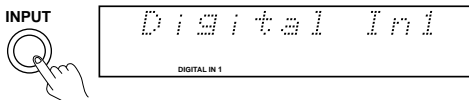

Note

CD-dubbing is not possible when "Analog In" or "Digital In 2" is shown on the display.

Check the available recording time on the MD.

If the display does not indicate the available recording time, press the DISPLAY button repeatedly.

DISPLAY



Note

A disc recorded in LP2 or LP4 mode can be played only on MD players that support LP2 or LP4 mode. If you play such a disc on another MD player, "LP:" may appear on the display.

4 Select a recording mode.

Press the REC MODE button to select the desired recording mode.

REC MODE



MONO : Monaural recording mode. The available recording time is twice as much as that for "SP."

SP : Normal stereo recording mode. The recording time is the same as the time length indicated on the CD.

LP2 : Normal stereo recording time is compressed to half. The available recording time is twice that for "SP."

LP4 : Normal stereo recording time is compressed to a quarter. The available recording time is four times that for "SP."

5 Select a CD dubbing mode.

5-1 Press the EDIT/NO button, then turn the AMCS knob until "CD Dub Mode?" appears.

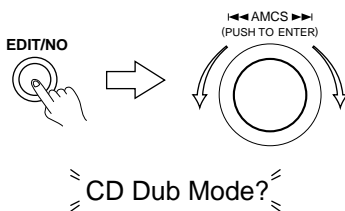

5-2 Press the AMCS knob. The current CD dubbing mode is shown. ("Fade → Album?" indicates that you are switching from Fade out to Album CD dubbing mode.)

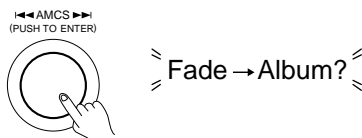

5-3 Press the AMCS knob. To cancel the CD dubbing mode setting, press the EDIT/NO button.

CD-dubbing (System operation)

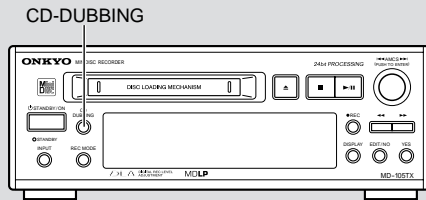

6 Press the CD DUBBING button on the MD-105TX.



The CD player automatically searches for the disc's peak level, while the MD-105TX sets the optimum peak level and then enters recording standby mode. The MD-105TX starts digitally recording the whole disc as soon as the disc's first track starts playing. (DLA Link)

The recording stops automatically when the playback of all disc tracks is completed.

To stop the recording...

Press the  button.

Tip:

You can check the currently-selected CD dubbing mode by pressing the CD DUBBING button during the dubbing operation.

DLA Link: Digital Rec Level Adjustment

CD-dubbing with track specified

When this MD recorder is configured into a system with the A-905TX/R-805TX and C-705TX, only one track with CD playing or pausing can be recorded by using the one-touch operation.

1 Play a CD

Play your desired track.



2 Press the CD DUBBING button.

Playing returns to the head of the current track. Only this track will be recorded (with DLA Link activated).



When the track reaches the end, next track will start and the MD recorder will stop.

Note

When the CD-dubbing mode is set to "Fade out," if the entire track cannot be recorded, the track will fade out at the end. When Album CD dubbing is selected and only one track is to be recorded, recording will continue until the end of the track is reached. The track will not be discarded if the end of the MD is reached in the middle of recording.

Recording

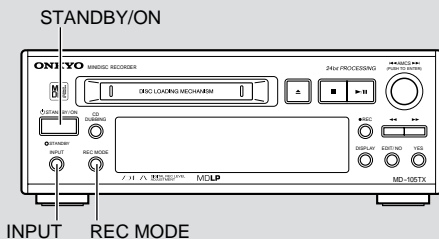

Analog recording

Recording analog data (data input via the connected audio pin cable)

1 Press the STANDBY/ON button.

The STANDBY indicator goes out.

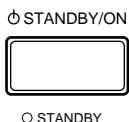

2 Load a recordable MD.



Insert an MD with the label side up, in the direction of the arrow.

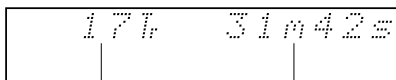

Number of recorded tracks on MD Total recorded time

Note

When "Protected" is shown in the display, it indicates that the record-protect tab of the MD is open. Before starting the recording procedure, close the tab. (See page 34.)

To check the time remaining for recording

When the MD recorder is stopped, press the DISPLAY button. Each press of the DISPLAY button changes the display as follows: The number of tracks on MD and the total recorded time → Remaining recording time on MD → Disc name ("No Name" when not set)

To record by erasing all of the existing tracks on a prerecorded MD

Erase all the tracks before you start recording (see page 36).

3 Press the INPUT button repeatedly until "Analog In" appears.

INPUT

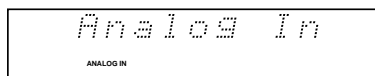

Note

- Make sure that the INPUT button and the REC button on the amplifier are set to an appropriate recording source.

4 Select a recording mode.

Refer to Step 4 on page 22 to select a recording mode.

REC MODE



5 Play the recording source.

If a CD player (such as the C-705TX) or a tape player (such as the K-505TX) has been connected to the system, start playing the CD or tape player.

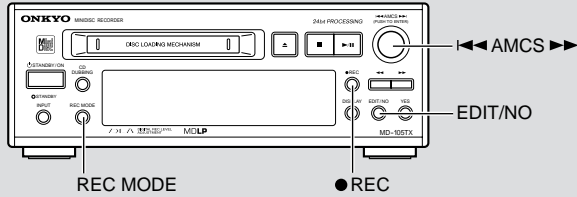

6 Press the ● REC button.

The MD recorder is now in recording standby mode.

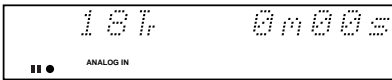

7 Using the AMCS knob, adjust the recording level.

Adjust the recording level.

7-1 Press the EDIT/NO button, then turn the AMCS knob until "Rec Level?" appears.

Then, press the AMCS knob.

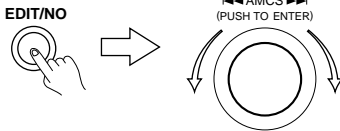

7-2 Turn the AMCS knob to adjust the recording level.

Adjust the recording level such that the -4 to -2 dB indicator lights when the input signal is largest. (Also refer to the current recording level readout displayed in dB.)

Tip:

You can adjust the recording level in 5dB steps for the range between -60.0 dB and -30.0 dB, in 2.5 dB steps for the range between -30.0 dB and -12.5 dB, and in 0.5dB steps for the range between -12.5dB and +18.0 dB.

Then, press the AMCS knob.

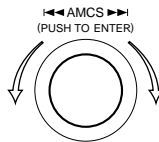

Adjust the level so the OVER indicator will not light up.



Adjust the level in the range between -4 and -2 for the maximum signal level.

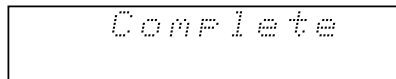

When the recording level adjustment is completed, stop playing the source.

Recording (continued)

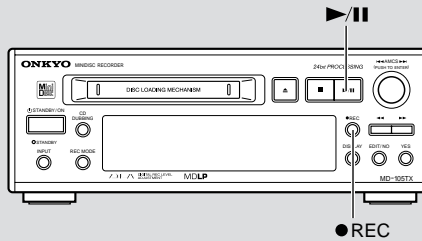

8 Press the ▶/|| button and then start playing the recording source immediately.

The TOC indicator appears as recording starts.

The MD recorder will automatically stop when recordable time on the disc expires. The tracks are automatically numbered. (Level Sync function)

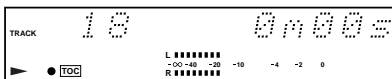
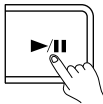

Since the interval between tracks is detected based on the sound level, some tracks may not be numbered correctly in the following cases:

- The recorded condition of the cassette tape is bad (noise between tracks).
- There is a low sound level in quiet music.
- The interval between tracks is extremely short.
- The tuner's reception is poor (noisy).

To disable the Level Sync function, refer to "Using the Level Sync function" on page 29.

To manually record a track number

While recording, press the ● REC button when you wish to mark a track number.

If you wish to mark two or more track numbers sequentially, provide a sufficient interval between each press of the ● REC button. Too short an interval (about 4 seconds or less) may lead to a failure in marking track numbers.

To stop recording temporarily...

Press the ▶/|| button (or the || button on the remote controller). To resume recording, press the ▶/|| button (or press the ▶ button on the remote controller).

To stop recording...

Press the ■ STOP button.

To eject the MD...

Press the ■ STOP button, then the ▲ EJECT button.

If the TOC indicator is lit steadily or flashing...

The track number and other information is written in the MD's TOC (Table of Contents) area when the MD recorder ejects the disc, enters stand-by mode, or stops recording.

Do not disconnect the power cable or move the unit under the following circumstances.

Otherwise, the information will not be written correctly.

• The TOC indicator is lit.

The information to be written into the MD's TOC area is currently stored in the recorder's memory.

• The TOC indicator is flashing.

The recorder is now writing the information in the MD's TOC area.

Recording (continued)

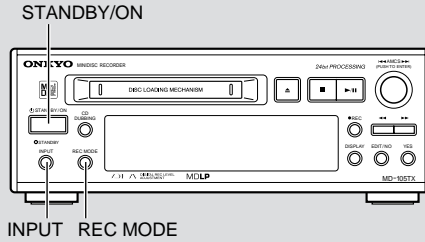

Digital recording

In digital recording, an optical digital cable is used to input signals from the recording source.

About digital recording

The MD-105TX is equipped with a sampling frequency converter, which enables you to record digital signals (PCM 32kHz and 48kHz) transmitted from external digital devices (DAT, satellite broadcast, etc.), as well as CDs (PCM 44.1kHz).

1 Press the STANDBY/ON button.

The STANDBY indicator goes out.

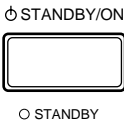

2 Load a recordable MD.

Refer to Step 2 on page 24.

3 Press the INPUT button repeatedly until "Digital In 1" or "Digital In 2" appears.

Digital input source 1 or 2 is now selected.

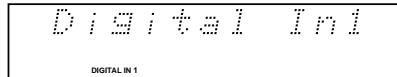
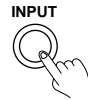

or

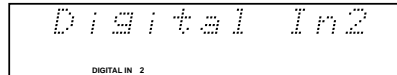

Note

- Make sure the supplied optical cable is connected to the correct digital input terminal. If you attempt to perform digital recording using a digital input terminal that is not connected, "D.In Unlock" will appear.
- Use the DIGITAL INPUT 1 digital input terminal if you connect the C-705TX CD player to this MD recorder.

4 Select a recording mode.

Refer to Step 4 on page 22.

5 Play the recording source.

If the C-705TX CD player is connected to the system, start playing the CD player.

(Continued on the next page)

Recording (continued)

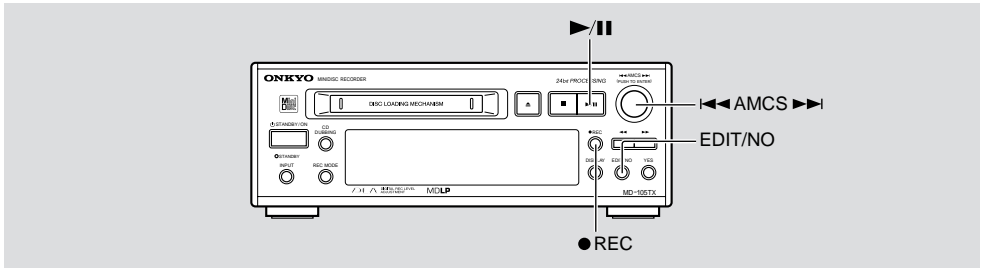

6 Press the ● REC button.

The MD recorder is now in recording standby mode.

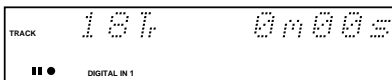

If "D. In Unlock" appears

The digital input source is not connected properly. Check the connection for the digital input source.

7 Adjust the recording level.

Refer to Step 7-1 and 7-2 on page 25.

8 Press the ►/|| button and then start playing the recording source immediately.

The TOC indicator appears as recording starts.

The MD recorder stops recording automatically when the remaining space on the MD is insufficient to record the next track.

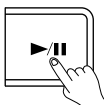

To stop recording temporarily

Press the ►/|| button (or the || button on the remote control). To resume recording, press the ►/|| button again (or press the ► button on the remote control).

To stop recording

Press the ■ button.

To eject the MD

Press the ■ button and then the ▲ EJECT button. Even with the Level Sync function turned off, recording digital data from a CD to an MD automatically numbers the tracks.

- For track numbers to be marked automatically, the signature code included in the digital signal at the beginning and end of each track is necessary. Some equipment and broadcasts do not include this signal, and in such a case track numbers will not be marked automatically.

In this case, the tracks are not numbered automatically. Use the Level Sync function described on the next page.

If the TOC indicator is lit steadily or flashing...

The track number and other information is written in the MD's TOC (Table of Contents) area when the MD recorder ejects the disc, enters stand-by mode, or stops recording.

Do not disconnect the power cable or move the unit under the following circumstances. Otherwise, the information will not be written correctly.

• The TOC indicator is lit.

The information to be written into the MD's TOC area is currently stored in the recorder's memory.

• The TOC indicator is flashing.

The recorder is now writing the information in the MD's TOC area.

Using the Level Sync function

The Level Sync function enables you to automatically number the tracks by detecting the rise of the signal level at the beginning of each track. (The Level Sync function is turned on by the default setting.)

To disable the auto numbering (Level Sync) function...

Follow the steps below during recording or stand-by mode:

1 Press the EDIT/NO button, then turn the AMCS knob until "Level Sync?" appears.

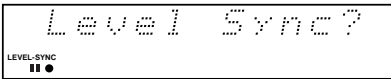
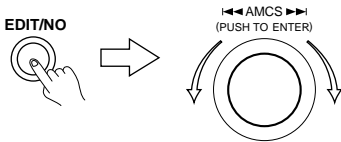

2 Press the AMCS knob.

The display indicates the current setting. (In this example, "On → OFF" appears, which means "Do you want to change from 'ON' to 'OFF'?")

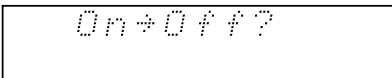

3 Press the AMCS knob.

The display indicates "Level Sync Off" and the tracks being recorded will not be numbered.

- To cancel this setting, press the EDIT/NO button.

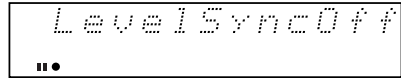

To enable the auto numbering (Level Sync) function...

Follow the steps described above, except that "OFF → ON" appears in Step 2 and "Level Sync On" appears in Step 3 when you press the AMCS knob. The tracks being recorded will be numbered automatically.

Using the Recording Auto Stop function...

The Recording Auto Stop function automatically stops recording about one minute after the recording source input (such as a midnight radio show) stops, as long as the Level Sync function is on.

About one minute after signal stops



Flashing

TOC flashes, then recording stops.

This function is useful if you do not wish to record after the source input stops. The function is disabled if the Level Sync function is off.

Note

- If you are recording the tracks from a CD that has intervals greater than one minute, the Recording Auto Stop function automatically stops recording. To continue recording such a CD, turn the Level Sync off.
- This function is disabled during the CD dubbing operation.

Signal Synchro recording

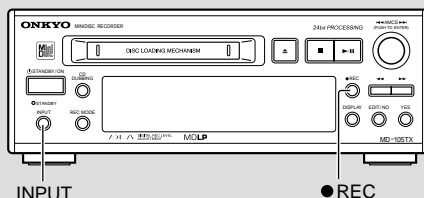

Even if your recording source is not Onkyo **RI**-compatible, you can perform synchronized recording. You can also make signal synchro recording from a connected CDR-205TX.

1 Press the INPUT button repeatedly until "Digital In 1," "Digital In 2," or "Analog In" appears.

- You can perform signal synchro recording with both digital and analog recording sources.

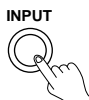

Digital In1

("Digital In 1" is selected.)

2 Select a recording mode.

Refer to Step 4 on page 22.

3 Press the ● REC button.

When the time indicator lights up on the display, press the REC button again. "Signal Rec" appears.



Signal Rec

↓
Signal Wait ↔ 0n00s

The recorder now waits for the input signal, and displays the "Signal Wait" message and the time indicator alternately.

Note

If no signal is input for approx .30 seconds, the MD recorder will enter recording standby mode.

4 Recording starts.

Recording starts as soon as the unit receives signals from the recording source while "Signal Wait" is displayed.

(Recording source)

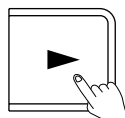

System operation

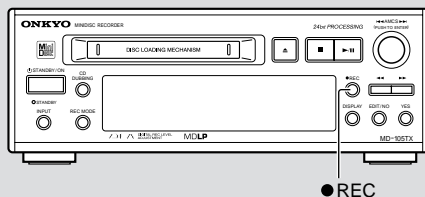

CD-synchro recording

When your MD recorder is configured into a system with Onkyo Separate Collection series components (A-905TX/R-805TX and C-705TX), the operation of the MD recorder can be synchronized with that of the CD player.

1 Set the MD recorder to recording standby mode.



- For information on setting the MD recorder to recording standby mode and the necessary preparatory steps, see “Analog recording” or “Digital recording.”

For digital CD-synchro recording

Connect the CD player’s (optical) digital output terminal to the MD-105TX’s DIGITAL INPUT 1 terminal.

2 Select a recording mode.

Refer to Step 4 on page 22.

3 Start playing the CD.

Press the play button on the C-705TX after the time indicator lights up on the recorder’s display. “Synchro Rec” appears and the recorder starts recording.

To adjust the recording level, refer to Step 7 on page 25.

(C-705TX)

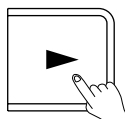

Synchro Rec

When the CD stops playing, the MD recorder stops recording and enters the recording standby mode.

To stop synchro recording, stop playing the CD. The MD recorder enters recording standby mode.

To stop CD-synchro recording

Press the  button on the CD player. The MD recorder then enters recording standby mode.

Note

- If you press the Pause button to restart playing the CD from pause mode, synchro recording is disabled. This is convenient when you wish to adjust the recording level.
- For analog recording, set the input selector of the A-905TX/R-805TX to the CD position and keep it placed in that position during recording. Changing the input selector setting causes the MD recorder to stop and enter recording standby mode.

(Continued on the next page)

System operation (continued)

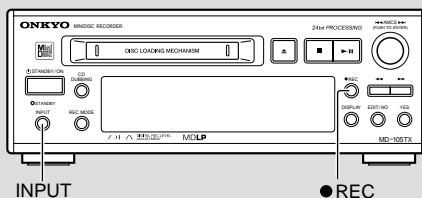

Synchro-recording from cassette deck or CD recorder to MD

When your MD-105TX is configured into a system with Onkyo Separate Collection series components (A-905TX/R-805TX, K-505TX and CDR-205TX), synchronized recording from the cassette deck to the MD recorder is possible.

1 Press the INPUT button repeatedly until "Analog In" appears.



- You cannot perform synchro recording with the "Digital In 1" or "Digital In 2" input sources.

2 Select a recording mode.

Refer to Step 4 on page 22.

3 Set the MD recorder to the recording standby mode.

- For information on setting the MD recorder to recording standby mode and the necessary preparatory steps, see "Analog recording" on page 24.



4 Start playing the cassette deck or CD recorder.

The MD recorder starts recording signals from the tape deck or CD recorder. If the recording level is not appropriate, refer to Step 7 on page 25 to adjust the level.

(K-505TX)

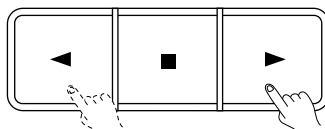

(CDR-205TX)

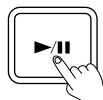

To stop synchro recording

Press the ■ button on the cassette deck or CD recorder. The MD recorder then enters recording standby mode.

System operation (continued)

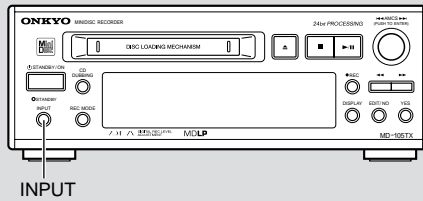

Timer operation

When your MD recorder is configured into a system with Onkyo Separate Collection series components (A-905TX and T-405TX), you can record the desired broadcasting programs or play your favorite MD at a specified time using the tuner's timer. See the T-405TX/R-805TX instruction manual for information on using the Timer function.

- 2 Press the INPUT button repeatedly until "Analog In" appears.**

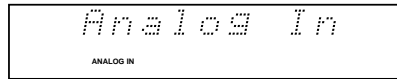

- 1 Insert an MD.**

You can both play and record.

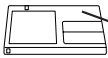
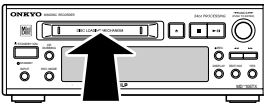

Insert an MD with the label side up, in the direction of the arrow.

- 3 Select a recording mode.**

Refer to Step 4 on page 22.

- 4 Set the timer on your T-405TX/R-805TX.**

Note

Connect the AC power cord of your MD-105TX to an AC outlet. If you connect the power cord to the outlet on the rear of the A-905TX, do not turn off the main power (POWER switch) of the A-905TX.

Other information for recording

Checking the contents of recording

- Stop recording and press the ►/■ button to play the tracks that were just recorded.
- To play from the beginning of the MD, stop recording, press the ■ button again, then press the ►/■ button or the ► button on the remote controller.

Notes regarding power outage

If you accidentally disconnect the power cord or an unexpected power outage occurs before you finish writing the recorded data to a disc (that is, while **TOC** is lit or flashing), the data recorded before the power outage will not be kept.

Protecting recordings from accidental erasure

You can protect your MDs from accidental recording by sliding the record-protect tab on the MDs to open the record-protect tab. To make the MDs recordable again, return the tab to the record-protect position.

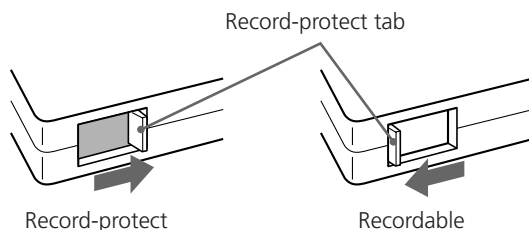

Editing the contents of an MD

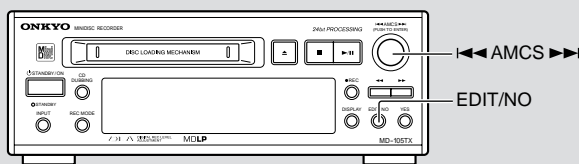

Erasing a track

The following operation is possible when the unit is stopped or paused.

- 1 Turn the AMCS knob until the track number you want to erase is displayed.

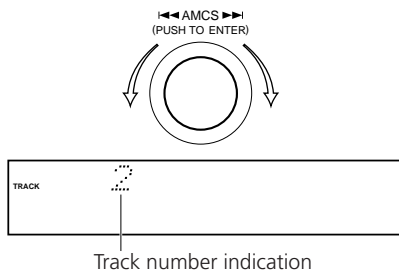

- 3 Press the AMCS knob.

The selected track is erased. When the erasing is complete, "Complete" appears in the display.

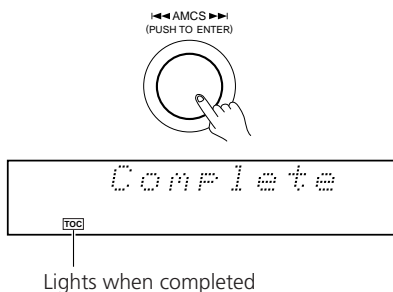

- 2 Press the EDIT/NO button and turn the AMCS knob to select "Erase?"

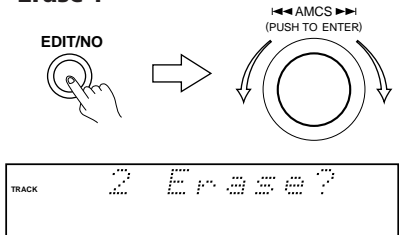

To stop erasing a track

Press the EDIT/NO button until "Erase?" disappears, or press the  button.

Deleting a track

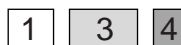

Updating the track numbers

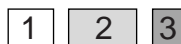

- When a track is erased, the tracks following that track are advanced. Each track is assigned a new number. For example, if you erase track 2, track 3 will be renumbered as track 2; track 4 will be renumbered as track 3, and so on.

Note

While the TOC indicator is lit or flashing, do not move or unplug the MD recorder.

Editing the contents of an MD (continued)

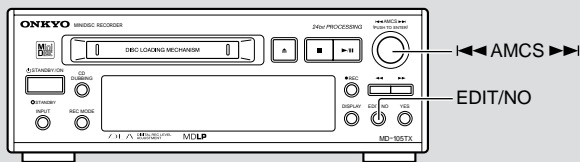

To erase all tracks of an MD

- 1 Press the button.
- 2 Press the EDIT/NO button and turn the AMCS knob to select "All Erase ?"
To cancel, press the EDIT/NO button or press the button.
- 3 Press the AMCS knob. "All Erase??" is displayed for confirmation.
- 4 Press the AMCS knob again.
When the erasing of all tracks on the MD is complete, "Complete" appears in the display.

Note

While the TOC indicator is lit or flashing, do not move or unplug the MD recorder.

Dividing a track

The following operation is possible when the playback is in progress or paused.

1 Pause a track at the desired dividing point.

2 Press the EDIT/NO button and turn the AMCS knob to select "Divide ?"

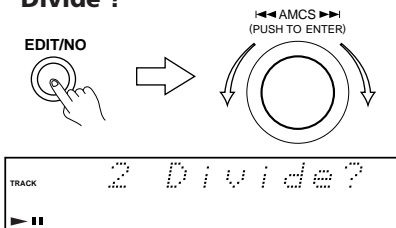

To stop dividing a track

Press the EDIT/NO button until "Divide?" disappears, or press the button.

3 Press the AMCS knob.

The point at which the track is to be divided plays repeatedly, with "Rehearsal" and "Position OK?" alternately shown on the display.

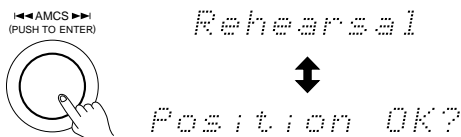

4 Fine-adjust the dividing point.

To fine-adjust the dividing point...

Turn the AMCS knob while listening to the part that contains the dividing point. You can adjust the point in the range of -45 to +45 in steps described below. (The step varies depending on the selected recording mode.)

Adjustment step

SP: approx. 0.06 seconds
 MONO and LP2: approx. 0.12 seconds
 LP4: approx. 0.25 seconds

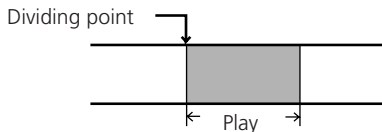
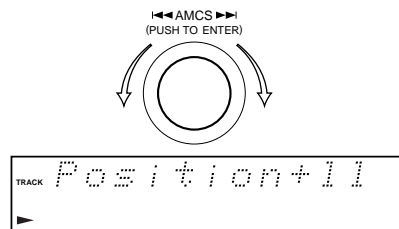

5 Divide the track.

Press the AMCS knob to divide the track. If a track with a name is divided into two parts, the former part takes over the name and the latter part is left without a name. When the dividing of the track is complete, "Complete" appears on the display.

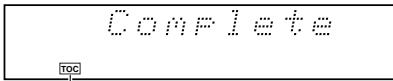

Lights when completed

Dividing a track

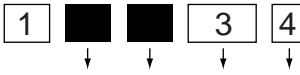

Updating the track numbers



Tip:

- The numbers of the tracks following the divided track will be increased by one. (For example, if you divide track 2 into two, the latter part of the track will become as track 3. Track 3 will be renumbered as Track 4, Track 4 will be renumbered as Track 5, and so on.)
- To erase parts of a track, first divide the track in parts, then erase the parts. (Refer to pages 52 and 53 for more information on erasing the tracks.)

Note:

While the TOC indicator is lit or flashing, do not move or unplug the MD recorder.

Combining tracks (Combine function)

- The Combine function enables you to combine two adjacent tracks into one. You cannot, however, combine a digital track and an analog track. You cannot combine two tracks that were recorded in different recording modes, either. For example, you cannot combine a track recorded in MONO mode and a track recorded in LP2 mode.
- This function is available while the recorder is stopped, paused, or playing.

1 Turn the AMCS knob to select the number of a track to be combined with the previous track.

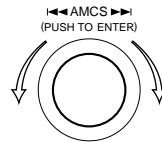

- The selected track will be combined with the previous track.
- If both of the combined tracks have names, the previous track's name will be used for the new track.
- If only the previous track has a name, the name will be used for the new track.
- If only the latter track has a name, the new track will not have a name.

2 Press the EDIT/NO button and turn the AMCS knob to select "Combine ?"

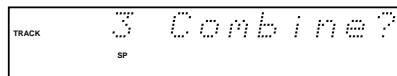
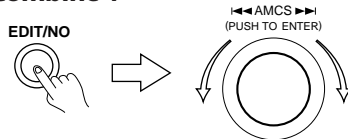

To cancel the Combine operation...

Press the EDIT/NO button or the button.

Editing the contents of an MD (continued)

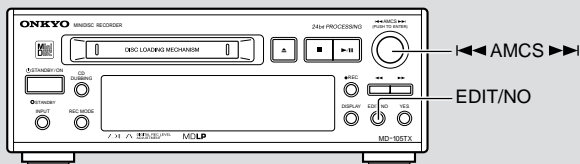

3 Press the AMCS knob.

The display indicates the numbers of two tracks to be combined.

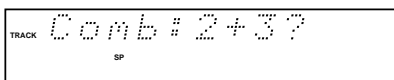
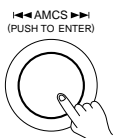

4 Press the AMCS knob again.

A short part (about eight seconds) that contains the combining point is played back repeatedly, with "Rehearsal" and "Track OK?" alternately shown on the display.

AMCS (PUSH TO ENTER)



Rehearsal



Track OK?

Combining point

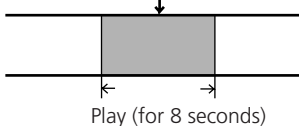

5 When the combining operation is completed, "Complete" appears on the display.

Tip:

The numbers of the tracks following the combined tracks will be decreased by one. (For example, if you combine Track 2 and Track 3, Track 4 will be renumbered as

AMCS (PUSH TO ENTER)

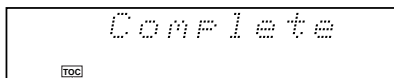

Lights when completed

Combining tracks



Updating the track numbers



Track 3, Track 5 will be renumbered as Track 4, and so on.)

Note:

While the TOC indicator is lit or flashing, do not move or unplug the MD recorder.

Editing the contents of an MD (continued)

Moving a track

The following operation is possible when the unit is stopped or paused.

- 1 Turn the AMCS knob until the track number you want to move is displayed.

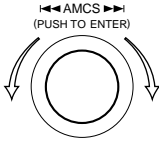

- 2 Press the EDIT/NO button and turn the AMCS knob to select "Move?"

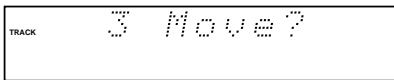
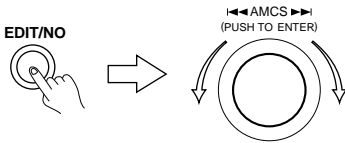

To stop moving a track

Press the EDIT/NO button until "Move?" disappears, or press the button.

- 3 Press the AMCS knob.

The selected track number and a destination track number appear in the display.

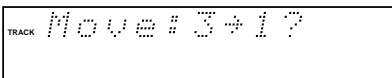

To specify the destination, turn the AMCS knob to select the desired number.

- 4 Press the AMCS knob to move the selected track.

When the moving of the track is complete, "Complete" appears in the display.

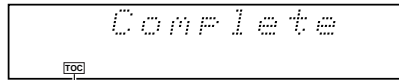
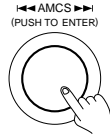

Lights when completed

Moving a track

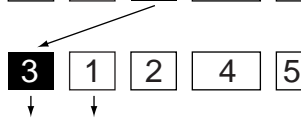

Updating the track numbers



- When a track is moved, the track numbers are renumbered, based on the track number of the moved track, so that they are consecutive. For example, if you move track 3 to track 1, track 1 will be renumbered as track 2; track 2 will be renumbered as track 3, and so on.

Note

While the TOC indicator is lit or flashing, do not move or unplug the MD recorder.

Naming a track or disc

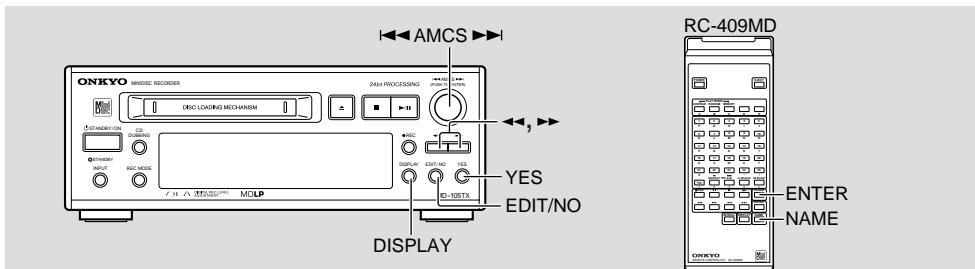

To name a disc

The MD recorder must be stopped.

To name a track

The MD recorder may be stopped, paused, playing, or recording.

(The characters being entered are canceled if the track that is playing or being recorded changes.)

1 Turn the AMCS knob until the track number for which you want to enter a name is displayed.

- To name a disc, start from step 2, skipping step 1.

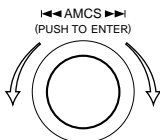

Note

When the MD recorder is paused, playing, or recording, the displayed track number is selected. Therefore this step is unnecessary.

2 Press the EDIT/NO button and turn the AMCS knob to select "Name In?".

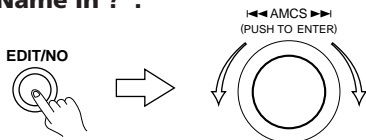

Or, with the supplied remote controller, press the NAME button.

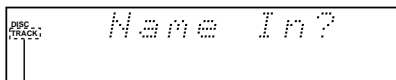

When you name a track, the "TRACK" indicator lights up.

To stop naming a disc or track

Press the EDIT/NO button several times until "Name In?" disappears, or press the ■ button.

3 Press the AMCS knob.

The blinking cursor appears.

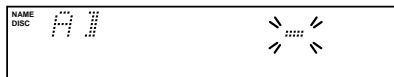
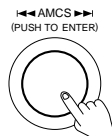

To cancel the naming operation while the cursor is blinking...

While pressing and holding down the EDIT/NO button, press the YES button. Alternatively, press the ■ button.

Naming a track or disc (Continued)

4 Select the character input mode using the DISPLAY button.

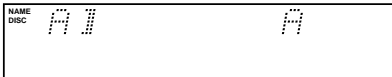

- You can enter upper case letters, lower case letters, numbers and symbols. Each press of the DISPLAY button changes the type of character you can enter as follows:

Upper case letter (A, B, C...)



Lower case letters (a, b, c...)



Numbers and symbols (1, 2, 3...)



Easy name (♪)

Refer to the next page for the type of characters you can enter.

- You can enter up to 100 characters, depending on the type of characters you enter.
- With the supplied remote controller (RC-409MD), press the DISPLAY button to change the character input mode.

5 Enter a track name or disc name using the AMCS knob.

Turn the AMCS knob to display the character you want to enter, and then press the AMCS knob to enter it.

Following the same procedure, enter the remaining characters.

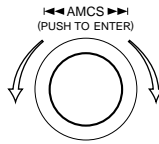

(RC-409MD)

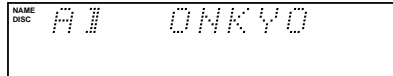
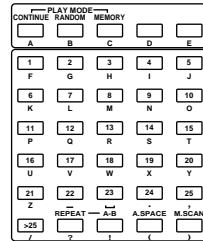

To enter a name using the supplied remote controller (RC-409MD)

You can enter numbers (1 to 9, and 0 with 10 button), uppercase and lowercase letters, and symbols (only those indicated below the buttons) by directly operating the buttons.

The ◀◀ and ▶▶ buttons on the remote control can be used to select characters. If this is the case, press the ENTER button or the ▶▶ button to enter them.

To change the type of characters entered

Go back to step 4 and change the character input mode. Then, select and enter characters using the AMCS knob.

To correct the character entered

Move to the character you want to correct using the ◀◀ and ▶▶ buttons (the character blinks). Then reenter the character you want.

To insert a character

Move to the point at which you want to insert a character using the ◀◀ and ▶▶ buttons (the insertion point blinks). Then turn the AMCS knob counterclockwise (♯ blinks) and press the AMCS knob (the cursor blinks). Finally, enter the character you want.

To erase a character

Move to the character that you want to erase using the ◀◀ and ▶▶ buttons (the character blinks). Then press the EDIT/NO button or CLEAR button on the remote controller (RC-409MD).

Naming a track or disc (Continued)

6 Press the YES button.

With the supplied remote controller (RC-409MD), press the NAME button.

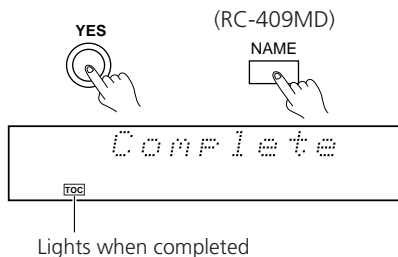

Note

If, after pressing the EJECT or STANDBY/ON button, the TOC indicator is flashing, it indicates that the MD recorder is writing the recorded contents onto the MD. To ensure correct writing to the MD, do not disconnect the power cord (mains lead) or move the unit during this period.

The following characters can be entered:

ABCDEFGHIJKLMNOPQRSTUVWXYZ
abcdefghijklmnopqrstuvwxyz
0123456789_@`<># \$ % & *
= ; : + - / () ? ! , . _ (space) # (insert)

Preset names for easy naming

In the Easy Naming mode, you can enter the following names by simply choosing one.

BALLAD	German
BLUES	Japanese
CLASSIC	Anthology
DANCE	Best of
FUSION	(One space will be added following "of".)
JAZZ	Collection
LIVE	Favorite
POPS	Happy
REGGAE	Heavy
ROCK	Hit Songs
SOUL	Omnibus
TECHNO	Selection
VOCAL	Special
African	Super
American	Space ()
Asian	(To enter a space, choose the symbol _.)
British	
Euro	

Erasing the disc name and all track names at one time

1 Press the STOP button.

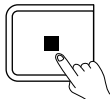

2 Press the EDIT/NO button and turn the AMCS knob to select "Name Erase?".

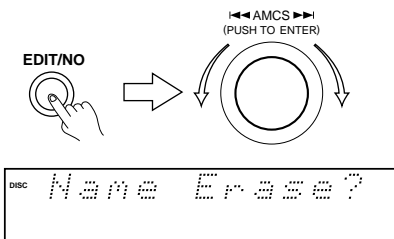

3 Press the AMCS knob.

All track names and the disc name are erased.

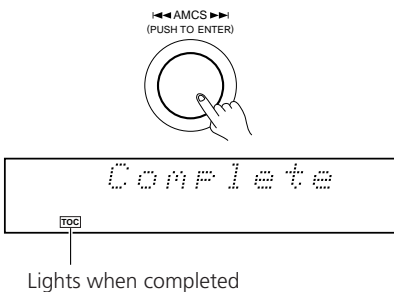

Message list

The following table explains the various messages that appear in the display.

Message	Meaning
Auto Space	This message appears during the track intervals when A. Space is turned on.
Blank Disc	A new recordable MD or a recordable MD without disc or track names is inserted.
Cannot Copy	An attempt was made to record copyright-protected material. An attempt was made to make a second copy from a digitally dubbed MD (see "Rules for Digital Recording" on page 45).
Cannot Edit	An attempt was made to edit the disc during MEMORY or RANDOM play or in recording standby mode, or an attempt to edit a premastered disc was made.
Cannot Rec	An attempt was made to record onto a premastered (read-only) disc.
CD Dub Fail	The CD dubbing operation could not be enabled. Check the connections. (An RI cable or audio pin cable is not connected. Or, the amplifier or CD player is not turned on.)
Complete	Editing is complete.
D. In Unlock	The digital equipment (CD player, DAT, etc.) has not been connected properly. Otherwise, the connected digital equipment is not operating properly.
Disc Error	The disc is abnormal (scratched or missing a TOC).
Disc Full	The disc is full (see "System Limitations" on the next page).
Full	An attempt was made to enter a character that exceeds the maximum character capacity.
Impossible	The disc could not be edited.
Mecha Error	An error occurred in the unit's internal mechanism.
Memory Full	An attempt was made to record a 26th track.
Music Scan	Music Scan has started.
Name Full	Number of characters has reached the limit for input to one MD.
No Change	The naming attempt failed.
No Disc	There is no disc in the unit.
No Track	The inserted disc has a disc title but no tracks.
Over	In pause mode (when playing is paused), the ►► (Fast Forward) button was pressed to the end of the disc.
Protected	The inserted disc is record-protected.
Retry Error	The recording attempt failed due to a consecutive disturbance or scratches on the MD.
Signal Wait	The unit has entered Signal Wait mode.
Synchro Rec	Synchro recording has started.
TOC Reading	The unit is reading the TOC from the MD.
TOC Writing	The unit is writing the recorded or edited contents to the MD.
TOC Error	The writing of the recorded or edited contents failed. Something is wrong with the TOC.

System limitations

The MD recording system in the unit is significantly different from those used in cassette and DAT decks and is characterized by the limitations described below. Note, however, that these limitations are due to the inherent nature of the MD recording system itself and not to mechanical causes.

- **“Disc Full” lights up before the disc has reached the maximum recording time (60, 74, or 80 minutes)**
When 256 tracks have been recorded on the disc, “Disc Full” lights up regardless of the total recorded time. More than 256 tracks cannot be recorded on the disc. To record new tracks, erase unnecessary tracks or use another MD.
- **“Disc Full” lights up before the maximum number of tracks is reached**
Fluctuations in emphasis within tracks are sometimes interpreted as track intervals, incrementing the track count and causing the “Disc Full” indication to light up.
- **The remaining recordable time on the MD does not increase even after erasing numerous short tracks.**
- **Some tracks cannot be combined with others**
Track combination may become impossible when tracks are edited.
- **The remaining recordable time on the MD may decrease by more than the total recorded time, depending on the status of the MD or how you record.**
- **Tracks created through editing may exhibit sound dropout during searching operations.**
- **Track numbers are not recorded correctly**
Incorrect assignment or recording of track numbers may result (1) when CD tracks are divided into several smaller tracks during digital recording, or (2) when certain CDs are recorded with the Level Sync On for automatic track marking.
- **“TOC Reading” appears for a long time**
If the inserted recordable disc is brand new, “TOC Reading” appears on the display longer than those that have been used.

Rules for digital recording

Guide to the serial copy management system

Since your MD unit uses the Serial Copy Management System (SCMS), MDs recorded through the digital input terminal cannot be used to make subsequent copies to other MDs through the digital output terminal. The following diagram shows a system for making copies through the digital or analog terminals.

Rule 1

You can record digital source (CD, premastered MD, and DAT equipment with a sampling frequency of 44.1 kHz) to a recordable MD through the digital input terminal. However, you cannot make subsequent copies from the recordable MD to other recordable MDs through the digital output terminal. Subsequent copies can only be made through analog output terminal.

Rule 2

You can record the digital input signal of a digital satellite broadcast onto a recordable MD via the digital input terminals on an MD recorder that is capable of handling a sampling frequency of 32 kHz or 48 kHz. You can then record the contents of this recorded MD (first-generation) onto another recordable MD via digital input terminals on the MD recorder to create a second-generation digital copy.

Note, however, that with some BS tuners, second-generation digital copying may not be possible.

Rule 3

A recordable MD with material recorded from analog sources (analog records or FM programs, etc.) through the line input terminal can be copied to another recordable MD through the digital output terminal.

However, you cannot make subsequent copies from the recordable MD to other recordable MDs through the digital output terminal. Subsequent copies can be made only through the analog output terminal.

- * When MD recorders are connected using analog terminals, the number of dubbings is unlimited.

Troubleshooting

Symptom	Cause	Remedy
STANDBY/ON button is pressed, but power does not come on.	<ul style="list-style-type: none">• Power cord plug is not properly connected to AC outlet.• The R-805TX's energy save function is enabled (when the R-805TX is connected).	<ul style="list-style-type: none">• Insert the plug firmly.• Press the R-805TX's STANDBY/ON button. The power to the MD-105TX will be turned on.
The unit does not operate or operates poorly.	<ul style="list-style-type: none">• The disc may be damaged ("Disk Error" appears).	<ul style="list-style-type: none">• Take the disc out and insert it again. If "Disk Error" remains, replace the disc. (See "Precautions for handling the MiniDisc (MD)" on page 48.)
The unit does not play.	<ul style="list-style-type: none">• Moisture has formed inside the unit.• The unit is not on.• The disc is inserted in the wrong direction.• The disc may not be recorded (the track numbers do not appear).	<ul style="list-style-type: none">• Take the MD out and leave the unit in a warm place for several hours until the moisture evaporates (See page 47).• Press the STANDBY/ON button to turn the unit on.• Slide the MD into the disc compartment with the label side up and the arrow pointing toward the opening until the unit grips it. (See page 13.)• Replace the disc with one that has been recorded.
The sound has a lot of static.	<ul style="list-style-type: none">• Strong magnetism from a television or a similar device is interfering with operations.	<ul style="list-style-type: none">• Move the unit away from the source of the magnetism.
The unit does not record.	<ul style="list-style-type: none">• The disc is record-protected ("Protected" appears).• The unit is not connected properly to the sound source.• The recording level is too low.• A premastered disc is inserted.• There is not enough time left on the disc.• The optical digital cable for audio use is not connected properly. ("D. In Unlock" appears.)	<ul style="list-style-type: none">• Close the record-protect tab. (See page 34.)• Make connections properly to the sound source.• Adjust the recording level properly.• Replace it with a recordable disc.• Replace it with another recordable disc with fewer recorded tracks.• Connect the optical digital cable properly or use analog input.
Noise is heard regularly during AM recording.	<ul style="list-style-type: none">• The indoor AM antenna is located near the recorder.	<ul style="list-style-type: none">• Distance the antenna from the unit.
Too much noise is heard.	<ul style="list-style-type: none">• The unit is placed near a strong magnetic field, such as a TV.	<ul style="list-style-type: none">• Distance the unit from the magnetic field.

Troubleshooting (Continued)

Symptom	Cause	Remedy
The disc name or track name cannot be entered.	<ul style="list-style-type: none">• The disc is record-protected ("Protected" appears).• A premastered (read-only) disc is inserted ("Cannot Rec" appears).	<ul style="list-style-type: none">• Close the record-protect tab. (See page 34.)• Replace it with a recordable disc.
System function cannot be used.	<ul style="list-style-type: none">• The system functions cannot be used.	<ul style="list-style-type: none">• Check all cable connections. The system functions cannot be used even if remote control (R1) cables are connected. Also connect the components using audio cables.• If the symptom still persists, disconnect the power cord plug, then connect the plug again. If this does not improve the condition, with the power cord plug connected, press and hold down the ■ button for more than five seconds and operate the unit.

- Excessive electrical interference may temporarily render this system's sensitive microcomputer inoperable. If this happens, unplug the system for at least five seconds.

Condensation

This is the same phenomena that causes windows to mist with water in a heated room during the winter.

The MD recorder also sometimes gets dew (water drops) on the optical lens inside the player under the following conditions.

- Immediately after you turn a heater on.
- If the MD recorder is placed in a room full of steam or dampness.
- If you suddenly bring the MD recorder from the cold outside into a warm room.

If the MD recorder is exposed to dew condensation

You can leave it as it is. Sometimes the recorder cannot read the disc signal by laser and the recorder will not work.

Depending on the surrounding conditions, you can remove the disc and leave the power on for one hour at most. The dew will evaporate and the recorder will work properly. If it doesn't work after several hours, please consult the nearest Onkyo authorized service center.

Precautions for handling the MiniDisc (MD)

The MD is housed in a cartridge, so you can handle it without worrying about dust and fingerprints. Even so, a dirty or warped cartridge may cause malfunction. Remember the following precautions so you can enjoy high-quality sound for a long time.

Do not touch the disc in the cartridge directly with your fingers.

Do not open the shutter by hand. Doing so may damage the disc.

Storage location

Avoid storing MDs in a place subject to direct sunlight, high temperature, or high humidity.

Regular care

Wipe off dust and dirt accumulated on the cartridge surface with a dry cloth.

Removing a partially inserted MD

If the "self-lock function" is activated and the MD cannot be removed, push the MD further into the MD recorder and then press the ▲ EJECT button to remove the MD.

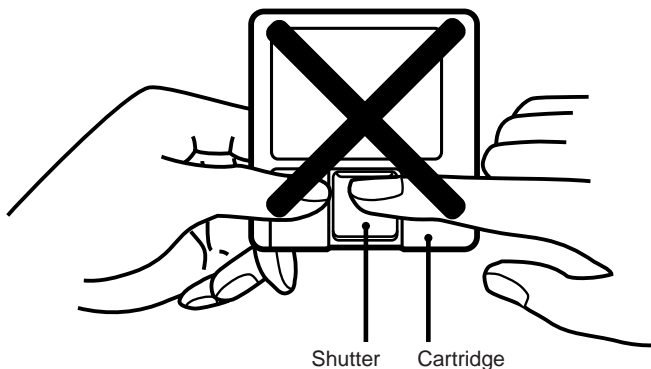

Indexed to parts and controls

Front panel

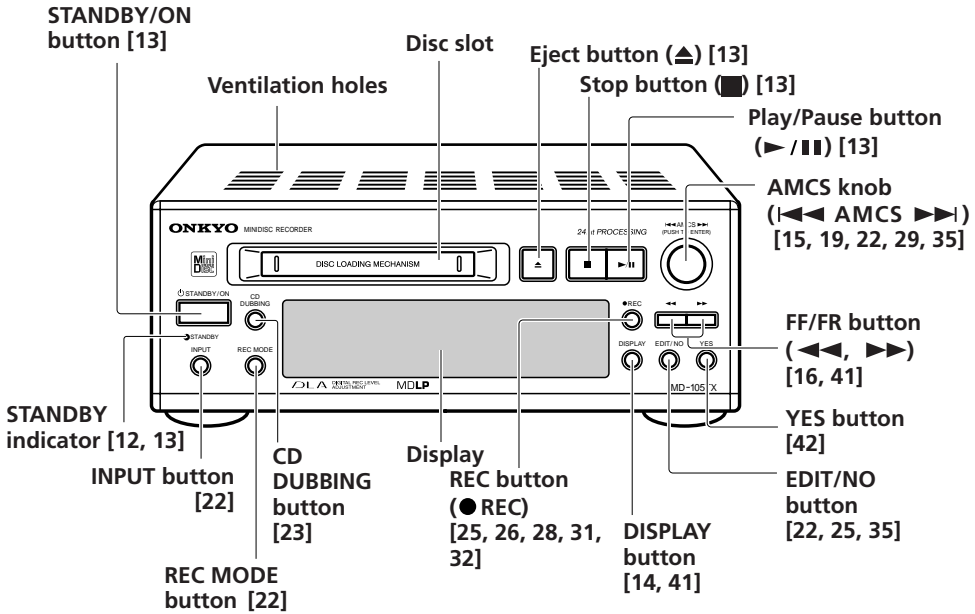

Display

A.SPACE indicator

M.SCAN indicator

REC MODE indicator

MEMORY indicator

NAME indicator

Time/Title display

RANDOM indicator

DISC/TRACK indicator

Peak level meter

NAME

DISC

TRACK

M.SCAN

A.SPACE

LEVEL-SYNC

MONO SP LP2 LP4

ANALOG IN

DIGITAL IN 12

L -∞ -40 -20 -10 -4 -2 0 OVER

R

MEMORY

RANDOM

REPEAT 1

Input setting indicator

TOC indicator

REC indicator

PAUSE indicator

PLAY indicator

LEVEL-SYNC indicator

REPEAT/REPEAT1 indicator

Remote controller

RC-409MD (supplied)

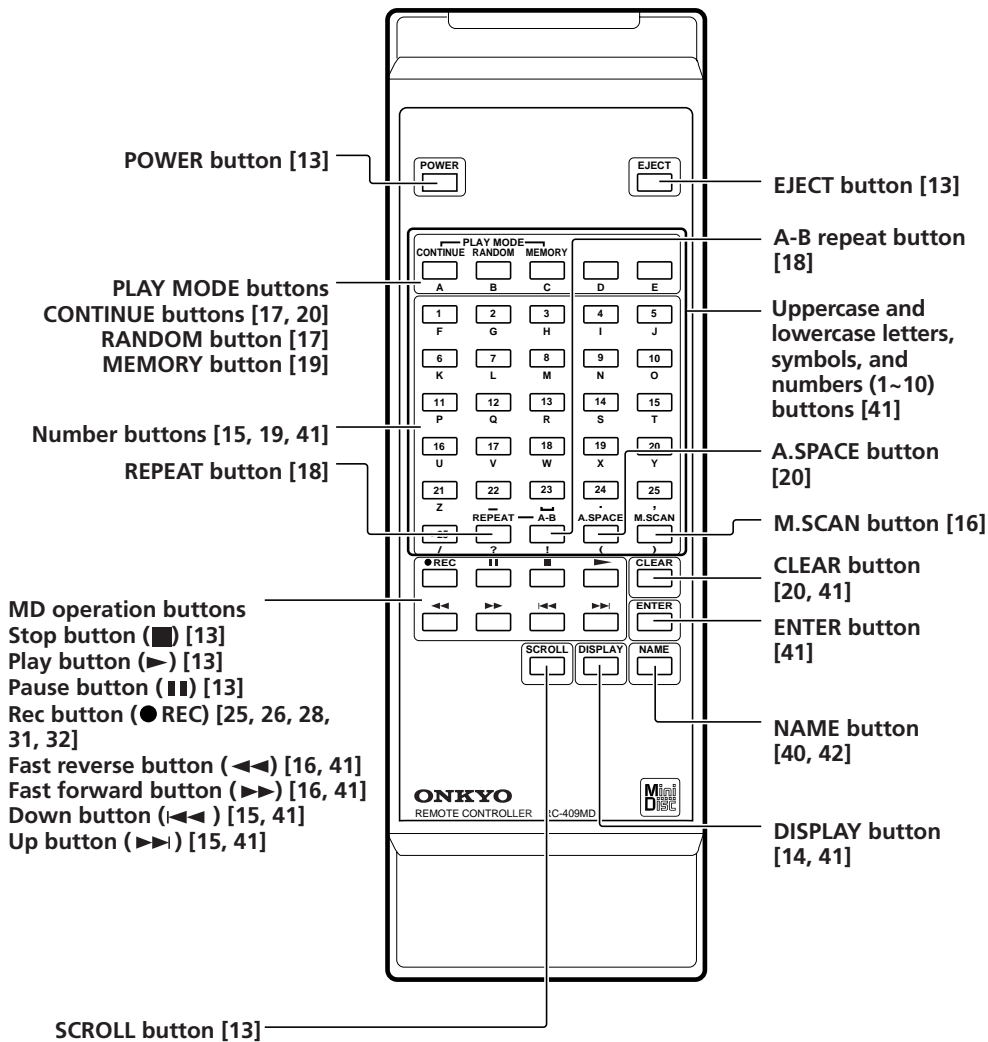

RC-456S (supplied with the A-905TX/R-805TX)

- MD operation buttons
- Stop button (■) [13]
- Play button (▶) [13]
- Pause button (⏸) [13]
- Rec button (● REC) [25, 26, 28, 31, 32]
- Down button (⏮) [15, 41]
- Up button (⏭) [15, 41]
- Repeat button (REPEAT) [18]
- Clear button (CLEAR) [20, 41]
- Scroll button (SCROLL) [13]
- Play Mode button (PLAY MODE) [17, 19]

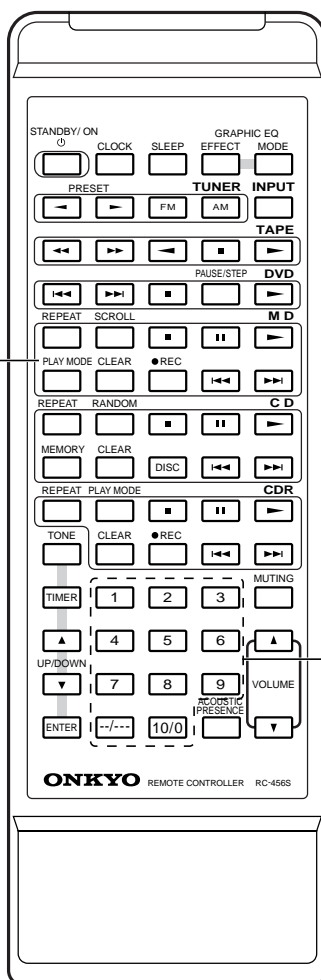

Number buttons [15, 19, 41]

Specifications

System

MiniDisc digital audio system

Recording system

Magnetic field modulation overwrite system

Signal read out system

Optical non-contact

Recording time

Stereo: Max. 80 min.
(when using MDW-80)
Mono: Max. 160 min.
(when using MDW-80)

Number of revolutions

About 400 - 900 rpm (constant linear velocity)

Error correction system

Advanced Cross Interleave Reed-solomon code

Sampling frequency

44.1 kHz

Number of channels

2 (stereo)

Frequency response

10 Hz - 20 kHz (± 0.5 dB)

Signal to noise ratio

100 dB or more when playing

Output level

2.0 volts r.m.s.

Power supply rating

AC 230-240 V, 50 Hz
AC 120 V, 60 Hz

Power consumption

13 watts (AC 230-240 V, 50 Hz)
17 watts (AC 120 V, 60 Hz)

Dimensions (W × H × D)

205 × 76 × 288 mm
(8-1/10" × 3" × 11-5/16")

Weight

2.4 kg (5.3 lbs)

Specifications and features are subject to change without notice.

ONKYO CORPORATION

Sales & Product Planning Div. : 2-1, Nisshin-cho, Neyagawa-shi, OSAKA 572-8540, JAPAN
Tel: 072-831-8111 Fax: 072-833-5222 <http://www.onkyo-intl.com>

ONKYO U.S.A. CORPORATION

18 Park Way, Upper Saddle River, N.J. 07458, U.S.A.
Tel: 201-785-2600 Fax: 201-785-2650 <http://www.onkyousa.com>

ONKYO EUROPE ELECTRONICS GmbH

Liegnitzerstrasse 6, 82194 Groebenzell, GERMANY
Tel: +49-8142-4401-0 Fax: +49-8142-4401-555 <http://www.onkyo.net>

ONKYO CHINA LIMITED

Units 2102-2107, Metroplaza Tower I, 223 Hing Fong Road, Kwai Chung, N.T., HONG KONG Tel: 852-2429-3118 Fax: 852-2428-9039



SN 29343102

Printed in Japan
I0105-1

