



Remote Interactive Dock

DS-A2X

Instruction Manual

Thank you for purchasing an Onkyo product. Please read this manual carefully before making any connections or using this product. By following these instructions, you'll get the best audio performance and the most listening pleasure from your Onkyo product. Keep this manual for future reference.

Contents

Important Safety Instructions	2
Precautions	3
Getting Started	4
About the RI Dock	4
Features	4
Package Contents	4
Compatible iPods	4
Getting to Know the RI Dock	5
Remote Controller	6
Hooking Up the RI Dock	8
Using the RI Dock	9
Setting the OSD Mode	9
Controlling Your iPod without the OSD	9
Controlling Your iPod with the OSD	9
TV Display Settings	11
Setting the TV System	11
Other Functions	11
Setting the Remote Controller's ID	12
Using Your Amp's Remote Controller	13
Troubleshooting	14
Specifications	15



WARNING:

TO REDUCE THE RISK OF FIRE OR ELECTRIC SHOCK, DO NOT EXPOSE THIS APPARATUS TO RAIN OR MOISTURE.

CAUTION:

TO REDUCE THE RISK OF ELECTRIC SHOCK, DO NOT REMOVE COVER (OR BACK). NO USER-SERVICEABLE PARTS INSIDE. REFER SERVICING TO QUALIFIED SERVICE PERSONNEL.



The lightning flash with arrowhead symbol, within an equilateral triangle, is intended to alert the user to the presence of uninsulated "dangerous voltage" within the product's enclosure that may be of sufficient magnitude to constitute a risk of electric shock to persons.



The exclamation point within an equilateral triangle is intended to alert the user to the presence of important operating and maintenance (servicing) instructions in the literature accompanying the appliance.

Important Safety Instructions

1. Read these instructions.
2. Keep these instructions.
3. Heed all warnings.
4. Follow all instructions.
5. Do not use this apparatus near water.
6. Clean only with dry cloth.
7. Do not block any ventilation openings. Install in accordance with the manufacturer's instructions.
8. Do not install near any heat sources such as radiators, heat registers, stoves, or other apparatus (including amplifiers) that produce heat.
9. Do not defeat the safety purpose of the polarized or grounding-type plug. A polarized plug has two blades with one wider than the other. A grounding type plug has two blades and a third grounding prong. The wide blade or the third prong are provided for your safety. If the provided plug does not fit into your outlet, consult an electrician for replacement of the obsolete outlet.
10. Protect the power cord from being walked on or pinched particularly at plugs, convenience receptacles, and the point where they exit from the apparatus.
11. Only use attachments/accessories specified by the manufacturer.
12. Unplug this apparatus during lightning storms or when unused for long periods of time.
13. Refer all servicing to qualified service personnel. Servicing is required when the apparatus has been damaged in any way, such as power-supply cord or plug is damaged, liquid has been spilled or objects have fallen into the apparatus, the apparatus has been exposed to rain or moisture, does not operate normally, or has been dropped.
14. Damage Requiring Service
Unplug the apparatus from the wall outlet and refer servicing to qualified service personnel under the following conditions:
 - A. When the power-supply cord or plug is damaged,
 - B. If liquid has been spilled, or objects have fallen into the apparatus,
 - C. If the apparatus has been exposed to rain or water,
 - D. If the apparatus does not operate normally by following the operating instructions. Adjust only those controls that are covered by the operating instructions as an improper adjustment of other controls may result in damage and will often require extensive work by a qualified technician to restore the apparatus to its normal operation,
 - E. If the apparatus has been dropped or damaged in any way, and
 - F. When the apparatus exhibits a distinct change in performance this indicates a need for service.

Precautions

- 1. Recording Copyright**—Unless it's for personal use only, recording copyrighted material is illegal without the permission of the copyright holder.
- 2. Care**—Occasionally you should dust the unit all over with a soft cloth. For stubborn stains, use a soft cloth dampened with a weak solution of mild detergent and water. Dry the unit immediately afterwards with a clean cloth. Don't use abrasive cloths, thinners, alcohol, or other chemical solvents, because they may damage the finish or remove the panel lettering.
- 3. Never Touch this Unit with Wet Hands**—Never handle this unit or its power cord while your hands are wet or damp. If water or any other liquid gets inside this unit, have it checked by your Onkyo dealer.

For U.S. models

FCC Information for User

CAUTION:

The user changes or modifications not expressly approved by the party responsible for compliance could void the user's authority to operate the equipment.

NOTE:

This equipment has been tested and found to comply with the limits for a Class B digital device, pursuant to Part 15 of the FCC Rules. These limits are designed to provide reasonable protection against harmful interference in a residential installation.

This equipment generates, uses and can radiate radio frequency energy and, if not installed and used in accordance with the instructions, may cause harmful interference to radio communications. However, there is no guarantee that interference will not occur in a particular installation. If this equipment does cause harmful interference to radio or television reception, which can be determined by turning the equipment off and on, the user is encouraged to try to correct the interference by one or more of the following measures:

- Reorient or relocate the receiving antenna.
- Increase the separation between the equipment and receiver.
- Connect the equipment into an outlet on a circuit different from that to which the receiver is connected.
- Consult the dealer or an experienced radio/TV technician for help.

For Canadian Models

NOTE: THIS CLASS B DIGITAL APPARATUS COMPLIES WITH CANADIAN ICES-003.

Modèle canadien

REMARQUE: CET APPAREIL NUMÉRIQUE DE LA CLASSE B EST CONFORME À LA NORME NMB-003 DU CANADA.

For some models

Before use, connect the appropriate AC plug adapter to the AC adapter.

The type of plug adapter depends on the place of purchase.

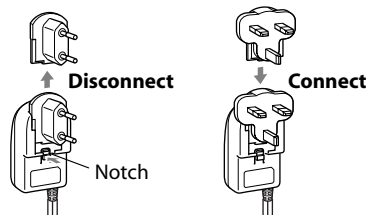

For European Models

Declaration of Conformity	
We, ONKYO EUROPE ELECTRONICS GmbH LIEGNITZERSTRASSE 6, 82194 GROEBENZELL, GERMANY	
declare in own responsibility, that the ONKYO product described in this instruction manual is in compliance with the corresponding technical standards such as EN60065, EN55013, EN55020 and EN61000-3-2, -3-3.	
GROEBENZELL, GERMANY	 K. MIYAGI
ONKYO EUROPE ELECTRONICS GmbH	

Getting Started

About the RI Dock

With the Onkyo RI Dock, you can easily play the music stored on your Apple* iPod through your Onkyo audio system and enjoy great sound, and watch iPod slideshows and videos on your TV. In addition, the onscreen display (OSD) allows you to view, navigate, and select your iPod's playlists (artists, albums, songs, genres, composers) on your TV, and with the supplied remote controller, you can control your iPod from the comfort of your sofa.

RI, which stands for Remote Interactive, is an exclusive Onkyo control system that allows all **RI**-capable Onkyo audio components to be turned on or off together, and your amp to turn on automatically and select the appropriate input source when playback is started on a source component. It also allows you to control your iPod with your amp's remote controller.

In this manual, the DS-A2X Remote Interactive Dock is referred to as the "RI Dock."

Features

- Play your iPod music through your Onkyo audio system and enjoy great sound**
- View, navigate, and select your iPod's playlists (artists, albums, songs, genres, composers) on your TV**
- Control your iPod from the comfort of your sofa with the supplied remote controller**
- Watch iPod videos and slideshows on your TV**
- Supports all iPods with an iPod connector, except 3rd generation iPods**
- Charges your iPod's battery while you enjoy your music**

For the latest information on the RI Dock, see the Onkyo Web site at: www.onkyo.com

* iPod is a trademark of Apple Inc., registered in the U.S. and other countries.

Package Contents

Make sure you have the following items:

- **DS-A2X Remote Interactive Dock**

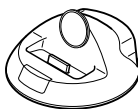

- **AC adapter (1.4 m, 4.59 feet)**



Adapter varies from country to country.

- **AV cable (1.8 m, 5.90 feet)**

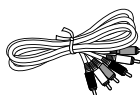

- **RI cable (1.7 m, 5.57 feet)**



- **Remote controller with button-type battery (CR 2025)**



- **Instruction manual**

Compatible iPods

■ Made for:

- **5th Generation iPod** (iPod with video)
- **iPod photo** (iPod with color display)
- **4th Generation iPod**
- **2nd Generation iPod nano**
- **1st Generation iPod nano**
- **iPod mini**

Note:

- **3rd generation iPods are not supported.**
- Before using the RI Dock, update your iPod with the latest software, available from the Apple Web site at: www.apple.com

Getting to Know the RI Dock

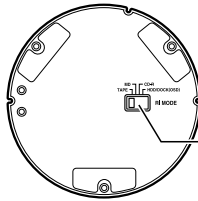
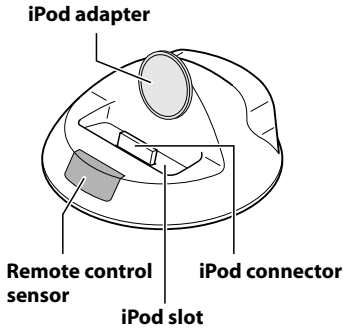

Set it to match your amp's input display (see below).

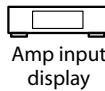
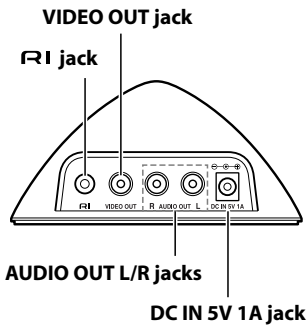

TAPE

MD

CDR

HDD or DOCK



See your amp's instruction manual for details on changing the input display. On some amps, you press and hold the [TAPE] button to change the input display from TAPE to MD, CDR, HDD or DOCK.



To control your iPod with your amp's remote controller, select the matching remote control mode.

■ Adjusting the iPod Adapter

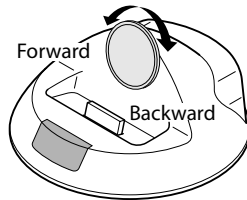
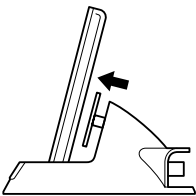

The iPod adapter needs to be adjusted to match your particular iPod. Insert your iPod into the RI Dock. If there's a gap between the back of your iPod and the adapter, turn the adapter counterclockwise to close the gap. Turning the adapter counterclockwise moves it forward. Turning it clockwise moves it backward.

Remote Controller

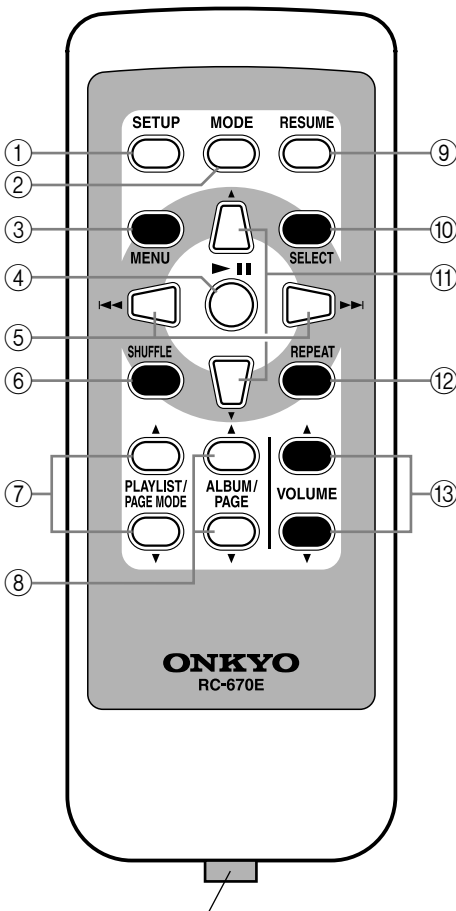

Remove the plastic film before using the remote controller.

- ① **SETUP button**
Used to set the TV system (PAL/NTSC) and the remote controller's ID.
- ② **MODE button**
Sets the OSD mode to On or Off.
- ③ **MENU button**
Used to select the previous menu on the onscreen display and iPod.

- ④ **Play/Pause [▶/⏸] button**
Starts or pauses playback of the selected song.
- ⑤ **Previous and Next [◀◀]/[▶▶] buttons**
The Previous [◀◀] button selects the previous track. During playback it selects the beginning of the current track. The Next [▶▶] button selects the next track.
Press and hold the Previous [◀◀] button to rewind. Press and hold the Next [▶▶] button to fast forward.
- ⑥ **SHUFFLE button**
Sets the Shuffle function to Songs, Albums, or Off.
- ⑦ **PLAYLIST/PAGE MODE [▲]/[▼] buttons**
Used to select the page modes. During playback or when the OSD mode is set to Off, they select playlists.
- ⑧ **ALBUM/PAGE [▲]/[▼] buttons**
Used to page through the playlists (artists, albums, songs, genres, composers) displayed on your TV. During playback or when the OSD mode is set to Off, they select albums.
- ⑨ **RESUME button**
Used to resume playback. It has no function when the OSD mode is set to Off.
- ⑩ **SELECT button**
Used to select songs and menus on the onscreen display and iPod.
- ⑪ **Up and Down arrow [▲]/[▼] buttons**
Used to navigate songs and menus on the onscreen display and iPod.
- ⑫ **REPEAT button**
Sets the Repeat function to One, All, or Off.
- ⑬ **VOLUME [▲]/[▼] buttons**
Adjust the volume on the Onkyo amp or AV receiver. They don't affect the iPod's volume setting.

Replacing the Battery

Use only a battery of the same type (CR 2025).

1. To open the battery compartment, press the small hollow and slide open the cover.

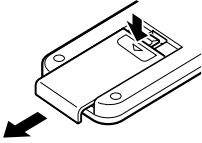

2. While pressing the tab as shown, slide out the old battery.

Slide the new battery into the battery compartment with the positive side facing up.

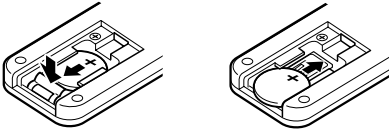

3. Slide the cover shut.

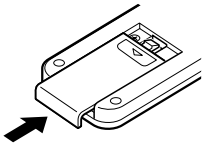

Notes:

- If the remote controller doesn't work reliably, try replacing the battery.
- If you intend not to use the remote controller for a long time, remove the battery to prevent damage from leakage or corrosion.
- An expired battery should be removed as soon as possible to prevent damage from leakage or corrosion.

Caution: Replacing the battery incorrectly may cause an explosion. Use only a battery of the same type or an equivalent.

Aiming the Remote Controller

When using the remote controller, point it toward the RI Dock's remote control sensor, as shown below.

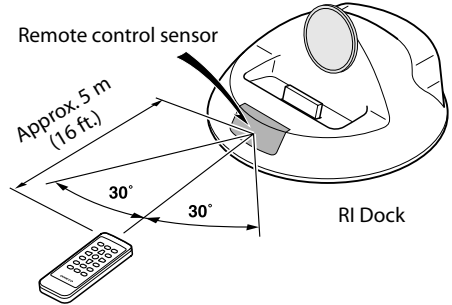

Notes:

- If the RI Dock is placed on top of another component, the remote controller's signal may be obstructed and the remote controller may not work reliably.
- The remote controller may not work reliably if the RI Dock is subjected to bright light, such as direct sunlight or inverter-type fluorescent lights. Keep this in mind when installing.
- If another remote controller of the same type is used in the same room, or the RI Dock is installed close to equipment that uses infrared rays, the remote controller may not work reliably.
- Don't put anything on top of the remote controller, such as a book or magazine, because a button may be pressed continuously, thereby draining the batteries.
- The remote controller may not work reliably if the RI Dock is installed in a rack behind colored glass doors. Keep this in mind when installing.
- The remote controller will not work if there's an obstacle between it and the RI Dock's remote control sensor.

Hooking Up the RI Dock

Depending on the Onkyo amp that you're using, choose connection method **A** or **B**.

A: Connect the RI Dock's AUDIO OUT L/R jacks and VIDEO OUT jack to an RI Dock-compatible input on your Onkyo amp. (You might need to change the input display to "HDD" or "DOCK.")

B: Connect the RI Dock's AUDIO OUT L/R jacks to the TAPE (MD, CDR) IN jacks on your Onkyo amp. And connect the RI Dock's VIDEO OUT jack directly to your TV.

See your amp's instruction manual for details.

Note: When the AC adapter is unplugged or not connected to the RI Dock, the RI Dock will output no sound or video, **RI** functions will not work, and your iPod's battery will not be charged.

Caution: Connect the supplied **RI** cable to only **RI** jacks. Do not connect headphones to the **RI** jack, as it will damage your equipment.

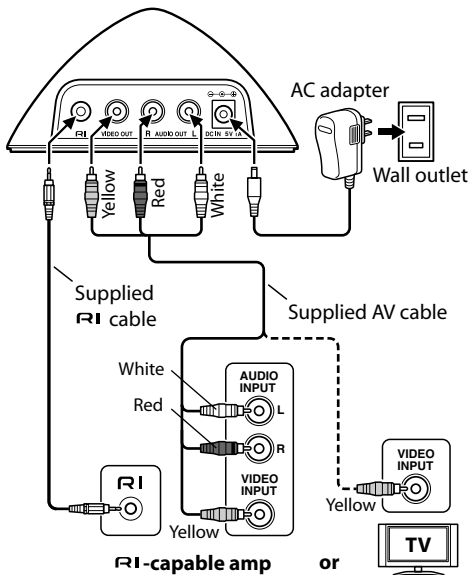

■ If you've connected the RI Dock's AUDIO OUT L/R jacks to your amp's TAPE (MD, CDR) IN jacks and also want to connect the RI Dock's VIDEO OUT jack to your amp

Connect the RI Dock's VIDEO OUT jack to an unused video input on your amp.

When you want to watch an iPod slideshow or video, select the video input source first, and then select the TAPE (MD, CDR) input source. Your AV receiver will output the audio being fed to the TAPE (MD, CDR) input, and because the video source doesn't change when the TAPE input source is selected, it'll continue to output the video being fed to the video input.

■ What to do if you already have a component connected to your amp's RI Dock-compatible input

Connect the RI Dock to an unused AV input on your amp. However, you will not be able to use any of the **RI** functions.

1. Using the supplied AV cable, connect the RI Dock's AUDIO OUT L/R jacks to a suitable audio input on your amp. And connect the RI Dock's VIDEO OUT jack to a video input on your Onkyo AV receiver (**A**) or TV (**B**). The input you use depends on the type of Onkyo amp you have. See your amp's instruction manual for details.
2. Using the supplied **RI** cable, connect the RI Dock's **RI** jack to an **RI** jack on one of the Onkyo components in your system.
3. Connect the supplied AC adapter to the RI Dock's DC IN jack.

Using the RI Dock

Setting the OSD Mode

Set the OSD (onscreen display) mode before you start using the RI Dock.

1. Plug in the AC adapter.
2. Turn on your TV and amp, and select the appropriate inputs on your TV and amp.
3. Insert your iPod into the RI Dock.



4. Use the remote controller's [MODE] button to set the OSD mode.



On: Playlists (artists, albums, songs, genres, composers) are displayed on your TV, and you can navigate and select your music while looking at your TV. While this mode is selected, your iPod displays the Onkyo logo.

Off: Nothing is displayed on your TV and you navigate and select your music by using your iPod's display.

Notes:

- To prevent iPod connector damage, don't twist your iPod when inserting or removing it, and be careful not to knock over the RI Dock while your iPod is inserted.
- Don't use the RI Dock with any other iPod accessories, such as FM transmitters and microphones, because they may cause a malfunction.
- You can't change the OSD mode while watching an iPod slideshow or video.

Controlling Your iPod without the OSD

To control your iPod without the OSD, set the OSD mode to Off, and use the remote controller as explained on page 6.

Controlling Your iPod with the OSD

When the OSD mode is set to On and your iPod is inserted in the RI Dock, playlists (artists, albums, songs, genres, composers) will be displayed on your TV.

■ Playing Songs

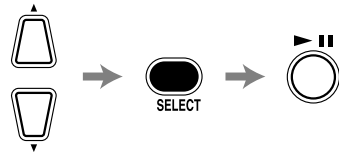

1. Use the Up and Down arrow [▲]/[▼] buttons to select Playlists, Artists, Albums, Genres, Songs or Composers, and then press the [SELECT] button.

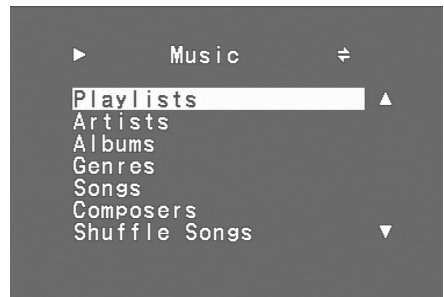

Top Menu

2. Use the Up and Down arrow [▲]/[▼] buttons and [SELECT] button to select a song, and press the Play/Pause [▶/■] button to start playback.

When selecting songs, use the [MENU] button to go back to the previous menu.

■ Using the Page Modes

With the page modes, you can quickly locate your favorite songs even when your song lists, artist lists, and so on are very long. There are four page modes: **L**, **M**, **S**, and **P**. These stand for Large, Medium, Small, and Page. In **P** mode, you can page through the list consecutively. In the **S**, **M**, and **L** modes, you can page through the list in progressively larger steps.

1. Use the PAGE MODE Up and Down [▲]/[▼] buttons to select a page mode. Depending on the size of the list, it may not be possible to change the page mode.
2. Use the PAGE Up and Down [▲]/[▼] buttons to page up or down the list.

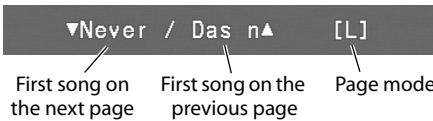

Note:

- While playing a playlist, you can use the PLAYLIST Up and Down [▲]/[▼] buttons to select other playlists. While playing an album, you can use the ALBUM Up and Down [▲]/[▼] buttons to select other albums.

■ Song Shuffle

You can play all of the songs in your iPod in random order.

- Press the [MENU] button repeatedly to select the top menu, and use the Up and Down arrow [▲]/[▼] buttons to select “Shuffle Songs,” and then press the [SELECT] button.

■ Now Playing

During playback, you can display information about the current song.

- Press the [MENU] button repeatedly to select the top menu, and use the Up and Down arrow [▲]/[▼] buttons to select “Now Playing,” and then press the [SELECT] button.

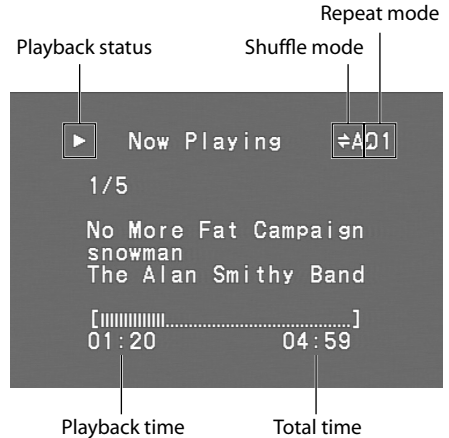

Shuffle modes

- [↔] Song shuffle
- [↔A] Album shuffle

Repeat modes

- [↺] All repeat
- [↺1] One-track repeat

■ Resume Function

With the Resume function, you can resume playback of the song that was playing when you removed your iPod from the RI Dock or changed the OSD mode to Off.

1. Select and play a song displayed on your TV.
2. During playback or while playback is paused, remove your iPod from the RI Dock or change the OSD mode to Off. The current song is remembered.
3. When you reinsert your iPod into the RI Dock (set the OSD mode to On), press the [RESUME] button to resume playback of the remembered song.

Notes:

- The Resume function can be used only when the OSD mode is set to On.
- If the AC adapter is disconnected, the remembered song will be forgotten.
- If the Resume function is used during shuffle playback, when the iPod is reinserted in the RI Dock, playback will resume with any song.

TV Display Settings

When the OSD mode is set to On, you can change the background color and set the screen saver.

1. Press the [MENU] button repeatedly to select the top menu.
2. Use the Up and Down arrow [▲]/[▼] buttons to select “Settings,” and then press the [SELECT] button.
3. Use the Up and Down arrow [▲]/[▼] buttons to select Background Color or Screen Saver, and then press the [SELECT] button.
4. Use the Up and Down arrow [▲]/[▼] buttons to select an option, and then press the [SELECT] button.

■ Background Color

You can change the background color of the onscreen display on your TV to any one of the following eight colors: None (black), Blue1, Blue2, Green1, Green2, Magenta, Red1, or Red2.

■ Screen Saver

You can set the time at which the screen saver is activated to any one of the following four options: 1 minute, 5 minutes, 10 minutes, or Off (screen saver off).

When the screen saver activates, the onscreen display on your TV disappears. Press any button on the remote controller to cancel the screen saver and resume the onscreen display.

Setting the TV System

While the OSD mode is set to On, you can set the RI Dock's video output to PAL or NTSC.

If the onscreen display looks distorted on your TV, try changing the TV system.

- While pressing and holding down the [SETUP] button, press the VOLUME Up [▲] button for more than 3 seconds to select NTSC, or press the VOLUME Down [▼] button for more than 3 seconds to select PAL.

Other Functions

■ RI Functions

Depending on your amp, you may also be able to use the following functions.

Note:

- Your amp may take several seconds to startup, so you might not hear the first few seconds of the first song.

• System On Function

When you turn on your amp, the iPod turns on as well. With some amps, you may need to press the [ON] button on your amp's remote controller's twice to turn on the other components in your system.

• System Off Function

When you turn off your amp, the iPod turns off as well.

• Auto Power On Function*

If you start iPod playback while your amp is on Standby, your amp will automatically turn on and select your iPod as the input source. Then, your iPod will start playback.

• Direct Change Function*

If you start iPod playback while listening to another input source, your amp will automatically select your iPod as the input source.

• Timer Play

You can use your amp's Timer function to turn on your amp and iPod and start playback at a specified time.

• Linked Dimmer Operation

When you use your amp's Dimmer function to change its display's brightness, the brightness of the RI Dock's Power indicator will change as well.

• Using Your Amp's Remote Controller

You can use your amp's remote controller to control basic iPod functions (see page 13).

* If you use your iPod's controls to start an iPod slideshow or video, these functions will not work, so use the remote controller instead.

Operating Notes:

- The RI Dock must be connected to your amp with both an **RI** cable and an audio cable to use the **RI** functions.
- If your amp doesn't support the System On, System Off, Auto Power On, and Direct Change functions, you'll need to turn your amp on and off and select the input source manually.
- Before you select another input source, stop iPod playback to prevent your amp from selecting the iPod input source by mistake.
- If any accessories are connected to your iPod, your amp may not be able to select the input source properly.
- While your iPod is in the RI Dock, its volume control has no effect. If you adjust your iPod's volume control while it's in the RI Dock, make sure it's not set too high before you reconnect your headphones.

■ Using Your iPod's Alarm Clock

You can use your iPod's Alarm Clock function to automatically turn on your iPod and amp at a specified time. Your amp's input source will automatically be set to the input to which your iPod is connected.

Notes:

- This function only works when the OSD mode is set to Off.
- To use this function, your iPod must be in the RI Dock, and the RI Dock must be connected to your amp with both an **RI** cable and an audio cable.
- When you use this function, be sure to set your amp's volume control to a suitable level.
- Your amp may take several seconds to startup, so you might not hear the first few seconds of the first song.

■ Charging Your iPod's Battery

The RI Dock charges your iPod's battery while your iPod is in the RI Dock.

Notes:

- To charge your iPod battery, the AC adapter must be plugged into a suitable wall outlet and connected to the RI Dock's DC IN jack.
- See your iPod's instruction manual for more information on battery charging.

Setting the Remote Controller's ID

If you cannot adjust the volume of your Onkyo component with the DS-A2X's remote controller, try changing its remote control ID. The default setting is #1.

Some Onkyo components are set to ID #2 or #3.

- While pressing and holding down the [SETUP] button, press one of the following buttons for more than 3 seconds to set the ID:
 - ID #1:** PLAYLIST Up [▲] button
 - ID #2:** ALBUM Up [▲] button
 - ID #3:** PLAYLIST Down [▼] button
 - ID #4:** ALBUM Down [▼] button

Using Your Amp's Remote Controller

The following table shows which buttons on your amp's remote controller you can use to control your iPod while it's in the RI Dock. Be sure to select the appropriate remote mode first, and point your remote controller at your amp. Note that some buttons may be labelled differently, and some remote controllers may not have certain buttons.

iPod function	Remote controller button to use				Description
	TAPE mode	MD mode	CDR mode	HDD mode	
Turn on/off	[STANDBY], [ON]			—	iPod is turned on and off.
Play	Play [▶]				Starts playback on the iPod. If the iPod is not already on, it's turned on automatically.
Pause	Pause [⏸], Stop [■]		Pause [⏸]		Pauses iPod playback.
Next song	[▶▶], [▶▶]	Next [▶▶]			Selects the next iPod song.
Previous song	[◀◀], [◀◀]	Previous [◀◀]			Restarts the current iPod song. Press it twice to select the previous song.
Fast forward	—	Fast Forward [▶▶]			Press and hold to fast forward the iPod.
Rewind	—	Rewind [◀◀]			Press and hold to rewind the iPod.

* To select the next or previous photo in an iPod photo slideshow, use the controls on your iPod photo.

The following functions can be used with some Onkyo amps.

iPod function	Remote controller button to use				Description
	TAPE mode	MD mode	CDR mode	HDD mode	
Shuffle	[DOLBY MODE]	[RANDOM], [PLAYMODE], [SHUFFLE]			Sets the iPod's Shuffle function to: Songs, Albums, or Off.
Repeat	[REVERSE MODE]	[REPEAT]			Sets the iPod's Repeat function to: One, All, or Off.
Backlight	REC [●]	[DISPLAY], [SCROLL]			The iPod's backlight comes on for 30 seconds.
Playlist/Album mode	Reverse Play [◀]	[ENTER], [PROGRAM], [MEMORY]		—	To use the next four functions with modes other than HDD, first select Playlist/Album mode by using one of these buttons, and then press the listed button while "Playlist/Album mode" is displayed on your TV (about 5 seconds).
Next playlist	Fast Forward [▶▶]			[PLAYLIST UP]	Selects the next playlist on the iPod. Select Playlist/Album mode first (see above).
Previous playlist	Rewind [◀◀]			[PLAYLIST DOWN]	Selects the previous playlist on the iPod. Select Playlist/Album mode first (see above).
Next album	Next [▶▶]			[ALBUM UP]	Selects the next album on the iPod. Select Playlist/Album mode first (see above).
Previous album	Previous [◀◀]			[ALBUM DOWN]	Selects the previous album on the iPod. Select Playlist/Album mode first (see above).

* Depending on your amp, some buttons may not work as expected.

Troubleshooting

■ There's no sound

- Make sure your iPod is actually playing.
- Make sure your iPod is inserted properly in the RI Dock.
- Make sure the RI Dock is connected to the correct input jacks on your amp. Do not connect it to any output jacks.
- Make sure your amp is turned on, the correct input source is selected, and the volume is turned up.
- Make sure the plugs are pushed in all the way.
- Make sure the AC adapter is connected to a suitable wall outlet and connected to the RI Dock.
- Try resetting your iPod.

■ The RI Dock's remote controller doesn't control your iPod

- If the RI Dock is placed on top of another component, the remote controller's signal may be obstructed and the remote controller may not work reliably. In this case, try repositioning the RI Dock (see page 7).
- Make sure your iPod is properly inserted in the RI Dock.
- When you use the RI Dock's remote controller, point it toward the RI Dock (see page 7).
- Some of the remote controllers buttons work differently depending on the OSD mode: On or Off (see page 6).

■ Your amp's remote controller doesn't control your iPod

- 3rd generation iPods are not supported.
- Make sure your iPod is properly inserted in the RI Dock. If your iPod is in a case, it may not connect properly to the RI Dock. Always remove your iPod from the case before inserting it into the RI Dock.
- The iPod cannot be operated while it's displaying the Apple logo.
- If your amp's remote controller has remote mode buttons, make sure you've selected the right mode.
- Check the RI Dock's RI MODE switch setting (see page 5).
- When you use your amp's remote controller, point it toward your amp.
- The RI Dock must be connected to your amp with both an **RI** cable and an audio cable.

- The TAPE IN on some amps can be set to TAPE, MD, or CDR. Make sure the RI Dock's RI MODE switch setting and the remote control mode match this setting. See your amp's manual for more information.
If you still can't control your iPod, start playback by pressing your iPod's Play button. Remote operation should then be possible.
- Make sure your amp's remote controller is set to the correct remote control ID.

■ The onscreen display doesn't appear on your TV

- Set the OSD mode to On (see page 9).
- Try setting the TV system to PAL or NTSC (see page 11).

■ To watch an iPod slideshow or video on TV:

- Set the OSD mode to Off, and use your iPod's controls or remote controller to select and start the slideshow or video.
- Make sure that your iPod's TV OUT setting is set to On.
- Make sure the correct input is selected on your TV or amp.
- Some versions of the iPod do not output video.

■ Your amp unexpectedly selects your iPod as the input source

- Always pause iPod playback when listening to another component that's connected to your amp. If playback is not paused, the Direct Change function may select your iPod as the input source by mistake when one track ends and another starts playing.

Caution: If you use this product under direct sunlight, fluorescent light, or germicidal lamp, ultraviolet or another elements in the light may change the product exterior color.

Specifications

Power supply:	AC adapter (5 V DC)
Power consumption (iPod not inserted):	0.5 W
Weight:	0.51 lbs. (230 g)
Dimensions (W x H x D):	4-7/16 x 2-3/8 x 4-7/16 inches 112 x 60 x 112 mm
Connectors:	VIDEO OUT, AUDIO OUT L/R, RI jack

Specifications and features are subject to change without notice.

In catalogs and on packaging, the letter at the end of the product name indicates the color. Specifications and operation are the same regardless of color.

- The operating instructions in this manual apply to the iPod as of May 2007, and may change with future upgrades to the iPod software.
- The AC adapter supplied with the DS-A2X is designed exclusively for use with the DS-A2X. Do not use it with another device. Likewise, do not use any other AC adapter with the DS-A2X, including those supplied with other RI Dock models. Doing so may damage the RI Dock.
- If there's any noise when listening to an FM or AM radio station on your tuner or receiver, try moving its antenna away from the RI Dock, iPod, and AC adapter's cable. In addition, don't wrap the AC adapter's cable around any other cables.

ONKYO CORPORATION

Sales & Product Planning Div. : 2-1, Nisshin-cho, Neyagawa-shi, OSAKA 572-8540, JAPAN
Tel: 072-831-8023 Fax: 072-831-8124

ONKYO U.S.A. CORPORATION

18 Park Way, Upper Saddle River, N.J. 07458, U.S.A.
Tel: 201-785-2600 Fax: 201-785-2650 <http://www.us.onkyo.com/>

ONKYO EUROPE ELECTRONICS GmbH

Liegnitzerstrasse 6, 82194 Groebenzell, GERMANY
Tel: +49-8142-4401-0 Fax: +49-8142-4401-555 <http://www.eu.onkyo.com/>

ONKYO EUROPE UK Office

Suite 1, Gregories Court, Gregories Road, Beaconsfield, Buckinghamshire, HP9 1HQ
UNITED KINGDOM Tel: +44-(0)1494-681515 Fax: +44(0)-1494-680452



ONKYO CHINA LIMITED

Unit 1&12, 9/F, Ever Gain Plaza Tower 1, 88, Container Port Road, Kwai Chung,
N.T., HONG KONG Tel: 852-2429-3118 Fax: 852-2428-9039
<http://www.ch.onkyo.com/>

I0705-1

SN 29344526

(C) Copyright 2007 ONKYO CORPORATION Japan. All rights reserved.



* 2 9 3 4 4 5 2 6 *