

# ONKYO

# CP-1050

Direct Drive Turntable

## Instruction Manual

Names and functions of parts ..... 6

Assembly and installation..... 7

Preparatory adjustments ..... 8

1. Horizontal balance..... 8

2. Stylus pressure ..... 9

3. Anti-skating..... 9

Connections ..... 10

Playing records ..... 11

Troubleshooting ..... 12

Thank you for purchasing an Onkyo product.  
Please read this manual thoroughly before making any connections and plugging in your new Onkyo product. Following the instructions in this manual will enable you to obtain optimum performance and listening enjoyment from your new product.  
Please retain this manual for future reference.

**WARNING:**

TO REDUCE THE RISK OF FIRE OR ELECTRIC SHOCK, DO NOT EXPOSE THIS APPARATUS TO RAIN OR MOISTURE.

**CAUTION:**

TO REDUCE THE RISK OF ELECTRIC SHOCK, DO NOT REMOVE COVER (OR BACK). NO USER-SERVICEABLE PARTS INSIDE. REFER SERVICING TO QUALIFIED SERVICE PERSONNEL.



**WARNING**  
RISK OF ELECTRIC SHOCK  
DO NOT OPEN

**AVIS**  
RISQUE DE CHOC ELECTRIQUE  
NE PAS OUVRIR



The lightning flash with arrowhead symbol, within an equilateral triangle, is intended to alert the user to the presence of uninsulated "dangerous voltage" within the product's enclosure that may be of sufficient magnitude to constitute a risk of electric shock to persons.



The exclamation point within an equilateral triangle is intended to alert the user to the presence of important operating and maintenance (servicing) instructions in the literature accompanying the appliance.

## Important safety instructions

1. Read these instructions.
2. Keep these instructions.
3. Heed all warnings.
4. Follow all instructions.
5. Do not use this apparatus near water.
6. Clean only with dry cloth.
7. Do not block any ventilation openings. Install in accordance with the manufacturer's instructions.
8. Do not install near any heat sources such as radiators, heat registers, stoves, or other apparatus (including amplifiers) that produce heat.
9. Do not defeat the safety purpose of the polarized or grounding-type plug. A polarized plug has two blades with one wider than the other. A grounding type plug has two blades and a third grounding prong. The wide blade or the third prong are provided for your safety. If the provided plug does not fit into your outlet, consult an electrician for replacement of the obsolete outlet.
10. Protect the power cord from being walked on or pinched particularly at plugs, convenience receptacles, and the point where they exit from the apparatus.
11. Only use attachments/accessories specified by the manufacturer.
12. Use only with the cart, stand, tripod, bracket, or table specified by the manufacturer, or sold with the apparatus. When a cart is used, use caution when moving the cart/apparatus combination to avoid injury from tip-over.
13. Unplug this apparatus during lightning storms or when unused for long periods of time.
14. Refer all servicing to qualified service personnel. Servicing is required when the apparatus has been damaged in any way, such as power-supply cord or plug is damaged, liquid has been spilled or objects have fallen into the apparatus, the apparatus has been exposed to rain or moisture, does not operate normally, or has been dropped.

PORTABLE CART  
WARNING



S3125A

### 15. Damage Requiring Service

Unplug the apparatus from the wall outlet and refer servicing to qualified service personnel under the following conditions:

- A. When the power-supply cord or plug is damaged,
- B. If liquid has been spilled, or objects have fallen into the apparatus,
- C. If the apparatus has been exposed to rain or water,
- D. If the apparatus does not operate normally by following the operating instructions. Adjust only those controls that are covered by the operating instructions as an improper adjustment of other controls may result in damage and will often require extensive work by a qualified technician to restore the apparatus to its normal operation,
- E. If the apparatus has been dropped or damaged in any way, and
- F. When the apparatus exhibits a distinct change in performance this indicates a need for service.

### 16. Object and Liquid Entry

Never push objects of any kind into the apparatus through openings as they may touch dangerous voltage points or short-out parts that could result in a fire or electric shock.

The apparatus shall not be exposed to dripping or splashing and no objects filled with liquids, such as vases shall be placed on the apparatus.

Don't put candles or other burning objects on top of this unit.

### 17. Batteries

Always consider the environmental issues and follow local regulations when disposing of batteries.

### 18. If you install the apparatus in a built-in installation, such as a bookcase or rack, ensure that there is adequate ventilation.

Leave 20 cm (8") of free space at the top and sides and 10 cm (4") at the rear. The rear edge of the shelf or board above the apparatus shall be set 10 cm (4") away from the rear panel or wall, creating a flue-like gap for warm air to escape.

# Precautions

- 1. Recording Copyright**—Unless it's for personal use only, recording copyrighted material is illegal without the permission of the copyright holder.
- 2. AC Fuse**—The AC fuse inside the unit is not user-serviceable. If you cannot turn on the unit, contact your Onkyo dealer.
- 3. Care**—Occasionally you should dust the unit all over with a soft cloth. For stubborn stains, use a soft cloth dampened with a weak solution of mild detergent and water. Dry the unit immediately afterwards with a clean cloth. Don't use abrasive cloths, thinners, alcohol, or other chemical solvents, because they may damage the finish or remove the panel lettering.

## 4. Power

### WARNING

BEFORE PLUGGING IN THE UNIT FOR THE FIRST TIME, READ THE FOLLOWING SECTION CAREFULLY.

AC outlet voltages vary from country to country. Make sure that the voltage in your area meets the voltage requirements printed on the unit's rear panel (e.g., AC 230 V, 50 Hz or AC 120 V, 60 Hz).

The power cord plug is used to disconnect this unit from the AC power source. Make sure that the plug is readily operable (easily accessible) at all times.

For models with [POWER] button, or with both [POWER] and [ON/STANDBY] buttons:

Pressing the [POWER] button to select OFF mode does not fully disconnect from the mains. If you do not intend to use the unit for an extended period, remove the power cord from the AC outlet.

For models with [ON/STANDBY] button only:

Pressing the [ON/STANDBY] button to select Standby mode does not fully disconnect from the mains. If you do not intend to use the unit for an extended period, remove the power cord from the AC outlet.

## 5. Preventing Hearing Loss

### Caution

Excessive sound pressure from earphones and headphones can cause hearing loss.

## 6. Batteries and Heat Exposure

### Warning

Batteries (battery pack or batteries installed) shall not be exposed to excessive heat as sunshine, fire or the like.

- 7. Never Touch this Unit with Wet Hands**—Never handle this unit or its power cord while your hands are wet or damp. If water or any other liquid gets inside this unit, have it checked by your Onkyo dealer.

## 8. Handling Notes

- If you need to transport this unit, use the original packaging to pack it how it was when you originally bought it.
- Do not leave rubber or plastic items on this unit for a long time, because they may leave marks on the case.
- This unit's top and rear panels may get warm after prolonged use. This is normal.
- If you do not use this unit for a long time, it may not work properly the next time you turn it on, so be sure to use it occasionally.
- When you've finished using this unit, remove all discs and turn off the power.

## 9. Installing this Unit

- Install this unit in a well-ventilated location.
- Ensure that there's adequate ventilation all around this unit, especially if it's installed in an audio rack. If the ventilation is inadequate, the unit may overheat, leading to malfunction.
- Do not expose this unit to direct sunlight or heat sources, because its internal temperature may rise, shortening the life of the optical pickup.
- Avoid damp and dusty places, and places subject to vibrations from loudspeakers. Never put the unit on top of, or directly above a loudspeaker.
- Install this unit horizontally. Never use it on its side or on a sloping surface, because it may cause a malfunction.
- If you install this unit near a TV, radio, or VCR, the picture and sound quality may be affected. If this occurs, move this unit away from the TV, radio, or VCR.

## 10. Moisture Condensation

### Moisture condensation may damage this unit.

Read the following carefully:

Moisture may condense on the lens of the optical pickup, one of the most important parts inside this unit.

- Moisture condensation can occur in the following situations:
    - The unit is moved from a cold place to a warm place.
    - A heater is turned on, or cold air from an air conditioner is hitting the unit.
    - In the summer, when this unit is moved from an air conditioned room to a hot and humid place.
    - The unit is used in a humid place.
  - Do not use this unit when there's the possibility of moisture condensation occurring. Doing so may damage your discs and certain parts inside this unit.
- If condensation does occur, unplug the power cord and leave the unit for two to three hours in the room temperature.

**For U.S. and Canadian models****FCC CAUTION**

Changes or modifications not expressly approved by the party responsible for compliance could void the user's authority to operate the equipment.

**NOTE:**

This equipment has been tested and found to comply with the limits for a Class B digital device, pursuant to part 15 of the FCC Rules. These limits are designed to provide reasonable protection against harmful interference in a residential installation. This equipment generates, uses and can radiate radio frequency energy and, if not installed and used in accordance with the instructions, may cause harmful interference to radio communications. However, there is no guarantee that interference will not occur in a particular installation. If this equipment does cause harmful interference to radio or television reception, which can be determined by turning the equipment off and on, the user is encouraged to try to correct the interference by one or more of the following measures:

- Reorient or relocate the receiving antenna.
- Increase the separation between the equipment and receiver.
- Connect the equipment into an outlet on a circuit different from that to which the receiver is connected.
- Consult the dealer or an experienced radio/TV technician for help.

**For Canadian Models****NOTE:**

CAN ICES-3 B/NMB-3 B

For models having a power cord with a polarized plug:

**CAUTION:**

TO PREVENT ELECTRIC SHOCK, MATCH WIDE BLADE OF PLUG TO WIDE SLOT, FULLY INSERT.

**For British models**

Replacement and mounting of an AC plug on the power supply cord of this unit should be performed only by qualified service personnel.

**IMPORTANT**

The wires in the mains lead are coloured in accordance with the following code:

- Blue: Neutral
- Brown: Live

As the colours of the wires in the mains lead of this apparatus may not correspond with the coloured markings identifying the terminals in your plug, proceed as follows: The wire which is coloured blue must be connected to the terminal which is marked with the letter N or coloured black. The wire which is coloured brown must be connected to the terminal which is marked with the letter L or coloured red.

**IMPORTANT**

The plug is fitted with an appropriate fuse. If the fuse needs to be replaced, the replacement fuse must be approved by ASTA or BSI to BS1362 and have the same ampere rating as that indicated on the plug. Check for the ASTA mark or the BSI mark on the body of the fuse. If the power cord's plug is not suitable for your socket outlets, cut it off and fit a suitable plug. Fit a suitable fuse in the plug.

**For European Models****Declaration of Conformity**

We declare, under our sole responsibility, that this product complies with the standards:

- Safety
- Limits and methods of measurement of radio disturbance characteristics
- Limits for harmonic current emissions
- Limitation of voltage changes, voltage fluctuations and flicker
- RoHS Directive, 2011/65/EU

**WEEE**

<http://www.onkyo.com/manual/weee/weee.pdf>

# Features

## Professional manual record player with a focus on sound quality

This is a manual player with simple functions that is designed with the highest priority placed on the sound quality for playing analog records. In terms of operations, usability is ensured with fittings such as a lifter for lowering and raising the tone arm. Also, the cartridge and head shell can be replaced.

## Composed of highly reliable parts

High reliability parts such as a MDF-manufactured cabinet for better sound quality, high rigidity aluminum die-cast turntable, high sensitivity tone arm, MM-type cartridge, etc., are used.

## High precision and stable direct drive system

High precision rotating performance is achieved with a quartz lock system. It is also equipped with an insulator to absorb external vibrations effectively.

## Luxurious finishing

A superior finishing reflecting the quality of the raw materials used is achieved by using a combination of aluminum parts arranged on the base of the operating unit and a cabinet with a soothing color tone.

# Supplied accessories

Before use, check whether the main unit and the accessories below are supplied.

- Turntable x 1

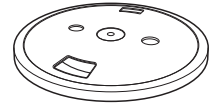

- Rubber mat x 1



- Counterweight x 1



- Head shell/Cartridge x 1

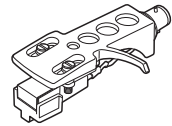

- Adapter for 45 rpm records x 1

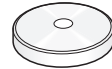

- Dust cover x 1

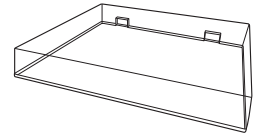

- Dust cover hinge x 2

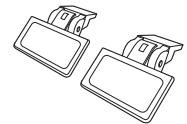

- Pin cables with attached grounding x 1

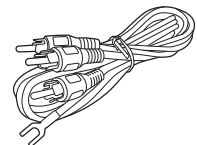

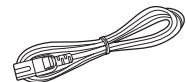

- Power cord x 1

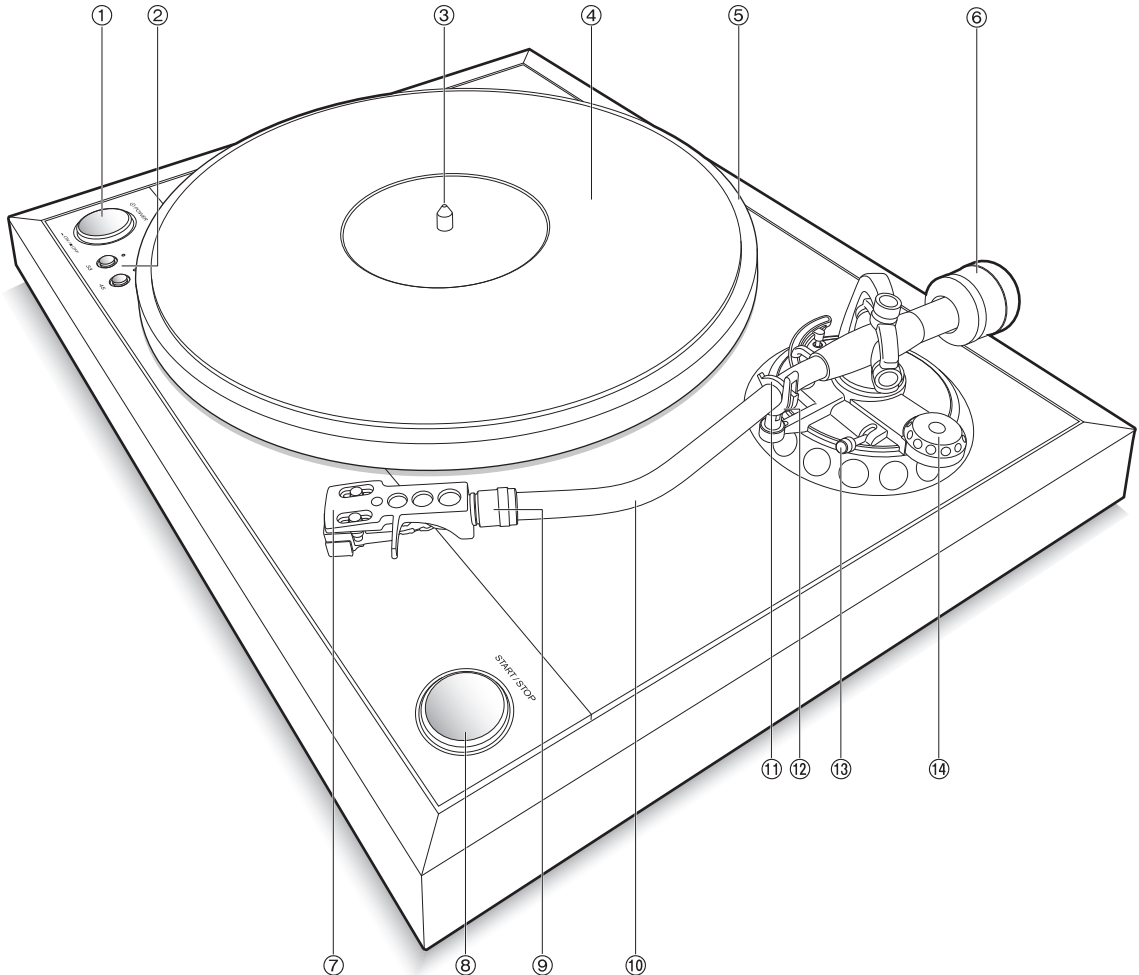

\* In catalogs and on packaging, the letter at the end of the product name indicates the color. Specifications and operations are the same regardless of color.

# Names and functions of parts



- ① **POWER button (  ON/  OFF):** Press this button to turn the unit on or off.
- ② **Speed selector button (33/45):** Set this button according to the record's playing speed.
- ③ **Center spindle**
- ④ **Rubber mat**
- ⑤ **Turntable**
- ⑥ **Counterweight:** Use this to balance the tone arm and to adjust the stylus pressure.
- ⑦ **Head shell**

- ⑧ **START/STOP button:** Rotates/stops the turntable.
- ⑨ **Locking nut:** Use this to install the head shell.
- ⑩ **Tone arm**
- ⑪ **Arm clamp:** Secures the tone arm to the arm rest.
- ⑫ **Arm rest:** Table to mount the tone arm.
- ⑬ **Lifter lever:** Use this to lift and lower the tone arm.
- ⑭ **Anti-skating knob:** Use this to adjust the anti-skating.

\* The turntable, rubber mat, counterweight and head shell are not fitted at the point of purchase. Refer to "Assembly" on the next page to assemble them.

# Assembly and installation

## Assembly

### 1. Mounting the turntable and rubber mat

1. Insert the turntable onto the center spindle.
  - Handle the turntable with care so that it does not drop onto or hit the unit, tone arm, etc.
2. Lay the rubber mat on top.

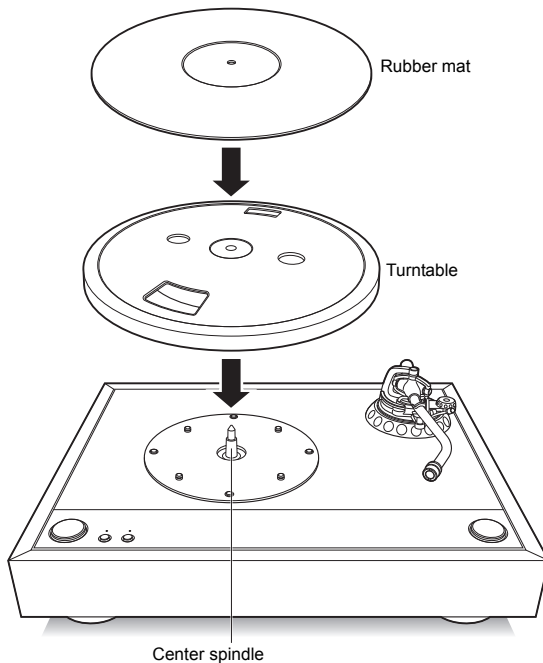

### 2. Mounting the head shell

Fit the head shell into the tone arm, keep it horizontal and tighten the locking nut.

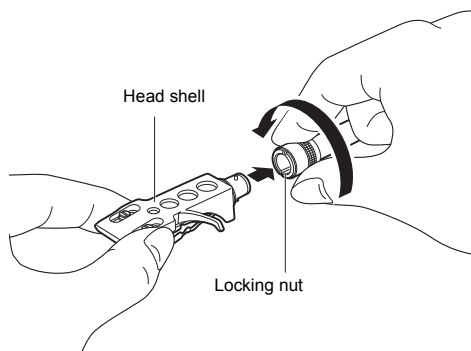

### 3. Mounting the counterweight

Mount the counterweight on the shaft at the back of the tone arm.

- Do not rotate the counterweight to a position where the white center line on the shaft at the back of the tone arm is no longer visible.

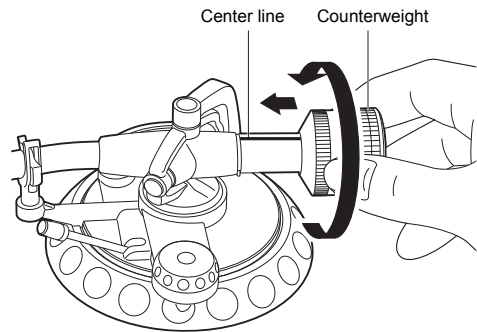

## Installation

Install the unit on a horizontal surface protected from vibrations.

- Do not place the unit on top of the amplifier or speaker system.
- Install the unit away from the speaker system so as to avoid the impact of vibrations and acoustic pressure.
- Ensure the unit is not exposed to direct sunlight, dust, humidity, and heat from a heating appliance.
- This unit may cause interference to radio broadcast if there is a radio nearby. Keep radios as far as possible from this unit.
- If you have any devices that emit high-intensity radio waves near the unit, such as a cellular phone that's being used to make a call, the unit may output noise.

### Adjust the unit horizontally

Place the unit where it is to be used and adjust the height of the insulators to make the unit horizontal.

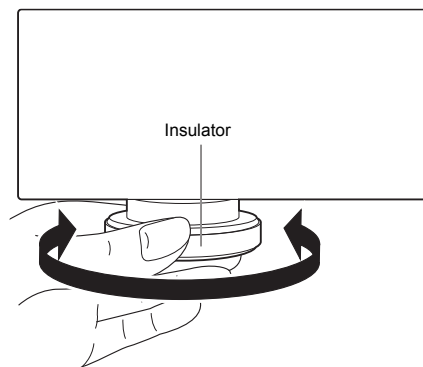

# Preparatory adjustments

## Handling the stylus

The tip of the stylus is extremely delicate. Be careful not to break or bend the stylus when removing the stylus cover. If the stylus tip is damaged, promptly replace it with a new stylus. If a damaged stylus is used, it will result in damage to the record.

## 1. Horizontal balance

The horizontal balance of the tone arm needs to be adjusted first in order to ensure that an appropriate stylus pressure is applied on the record. Carry out the adjustment with the power turned off.

1. Set the anti-skating knob to "0".

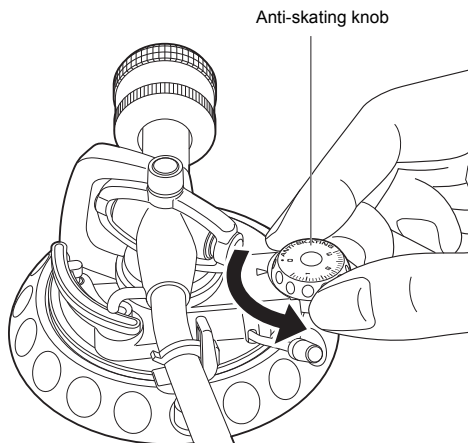

2. Remove the translucent stylus cover, taking care not to damage the stylus.

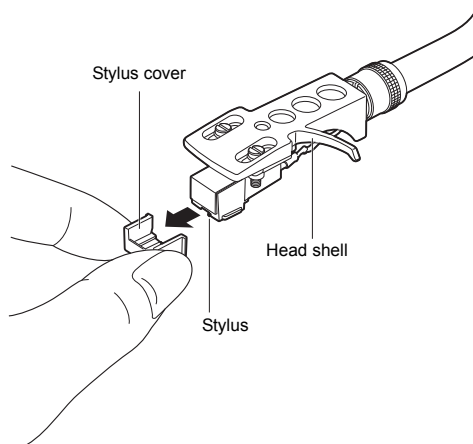

3. Release the arm clamp.

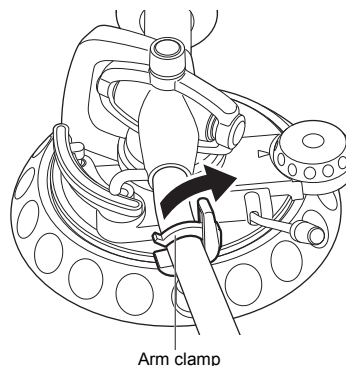

4. Free the tone arm from the arm rest. Leave the lifter lever in a lowered state.

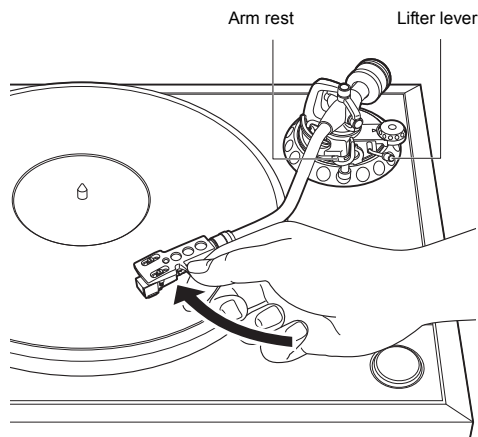

5. Turn the counterweight to adjust the tone arm so that it returns to an almost horizontal state (\*) when the hand is released. During adjustment, take care not to allow the stylus to touch the rubber mat or the turntable.

\* Ensure that the tone arm is balanced, so that the end of the tone arm is neither too high nor too low.

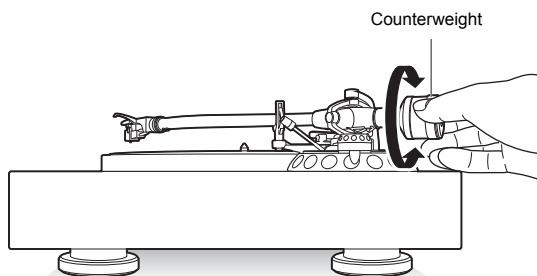

6. Return the tone arm to the arm rest and fix it with the arm clamp.



## 2. Stylus pressure

First turn the scale of the stylus pressure temporarily to "0" in a horizontally balanced state, and then adjust the stylus pressure.

If the stylus pressure is too high or too low, the record may not be played back correctly, or the stylus life may be shortened, or the record may be damaged. Be sure to adjust the stylus pressure to an appropriate value to match the cartridge.

1. Turn the stylus pressure adjustment ring so that the white center line on the shaft at the back of the tone arm is at "0".
  - Keep your fingers in contact with the stylus pressure adjustment ring only and turn it so that the counterweight does not turn at the same time.

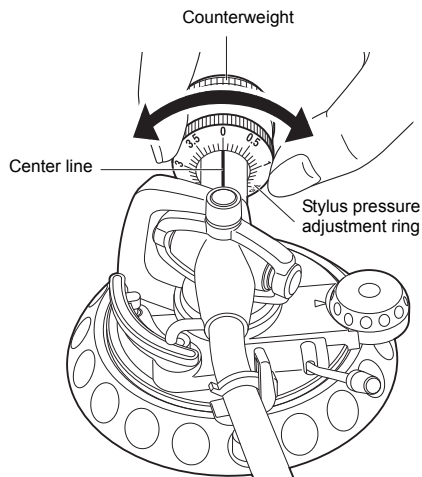

2. Turn the counterweight in the direction of the arrow so that the white center line on the shaft at the back of the tone arm is at "3.5".
  - When the counterweight is turned, the stylus pressure adjustment ring also turns.
  - When using a cartridge and head shell other than those supplied, adjust the stylus pressure to an appropriate value to match the cartridge after re-adjusting the horizontal balance.

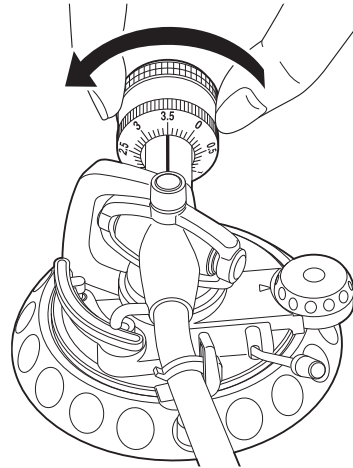

## 3. Anti-skating

When playing a record, a force pulling the stylus tip towards the inner circumference is generated. This force can be canceled by setting the anti-skating value to the same stylus pressure.

1. Turn the anti-skating knob to adjust it to the same scale as the stylus pressure. If the stylus pressure is "3.0" or higher like the supplied cartridge, adjust it to "3".

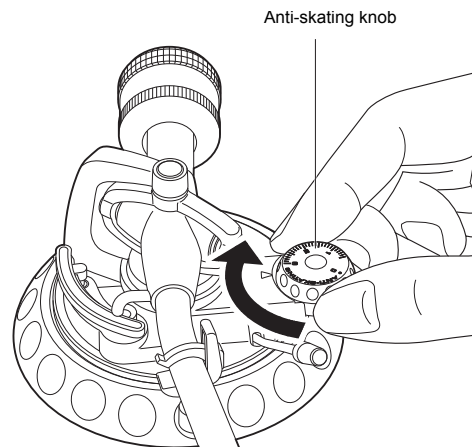

# Connections

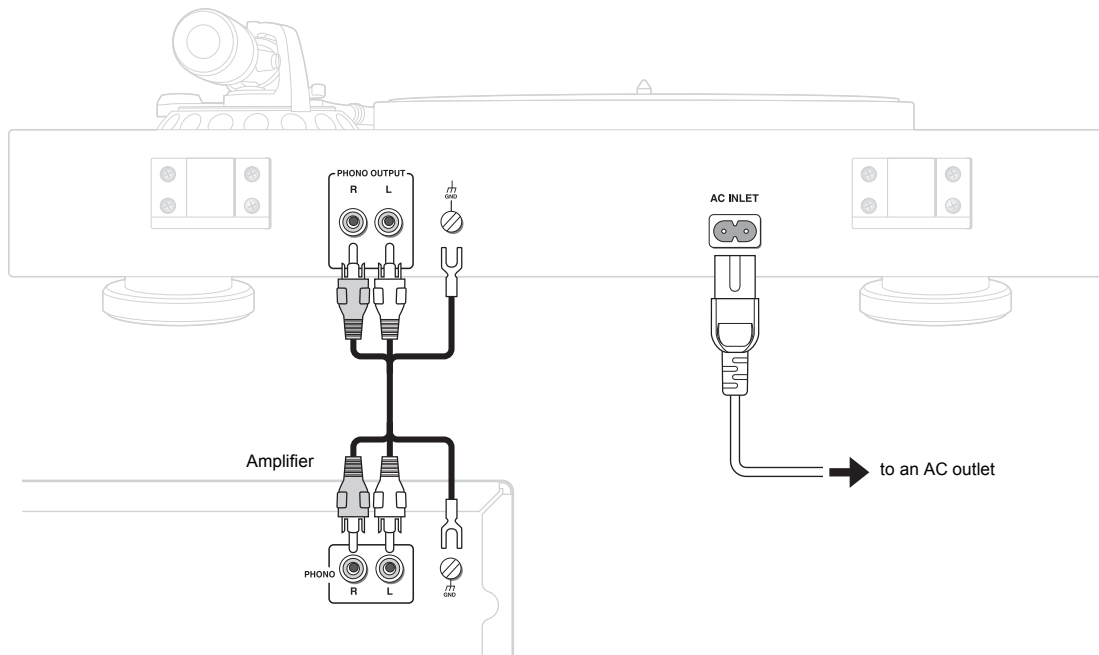

## 1. Connection with the amplifier

Connect the supplied pin cables with attached grounding to the PHONO OUTPUT terminals on the rear panel of the unit and the PHONO input terminals of the amplifier. Connect the red plug to the R terminal and the white plug to the L terminal respectively.

In addition, connect the grounding line of the pin cables with attached grounding to the GND terminal (ground terminal) of the rear panel of the unit and the amplifier.

### About the amplifier

If there is no PHONO input terminal on the amplifier used, connect a commercial phono-equalizer between the unit and the amplifier. See the instruction manual of the phono-equalizer for the connection method.

## 2. Connecting the power cord

Do not use a power cord other than the one supplied with this unit. Before connecting the power cord, connect all of your components.

Always connect the power cord to an AC outlet only after connecting it to the AC INLET terminal of the unit.

Disconnect the power cord only after turning the unit off. To avoid electrical shock, always disconnect the power cord from the AC outlet before disconnecting the other end.

## 3. Mounting the dust cover

1. Insert the two supplied dust cover hinges fully into the holder on the rear panel of the unit.
2. Adjust the square holes of the dust cover to the hinges and insert them fully into the hinges.

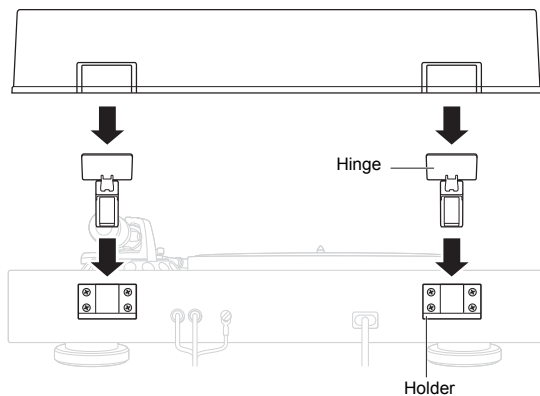

### Opening and closing the dust cover

Open and close the dust cover slowly. The stylus may jump if the player is subjected to shock during a musical performance.

### Removing the dust cover

After opening the dust cover fully, hold the dust cover at the back on both sides and pull it out from the top.

# Playing records

## Before playing the music

- Release the arm clamp.
- Turn on the power supply of the connected amplifier and switch the input so that the sound of this unit comes out. Keep the volume of the amplifier low.

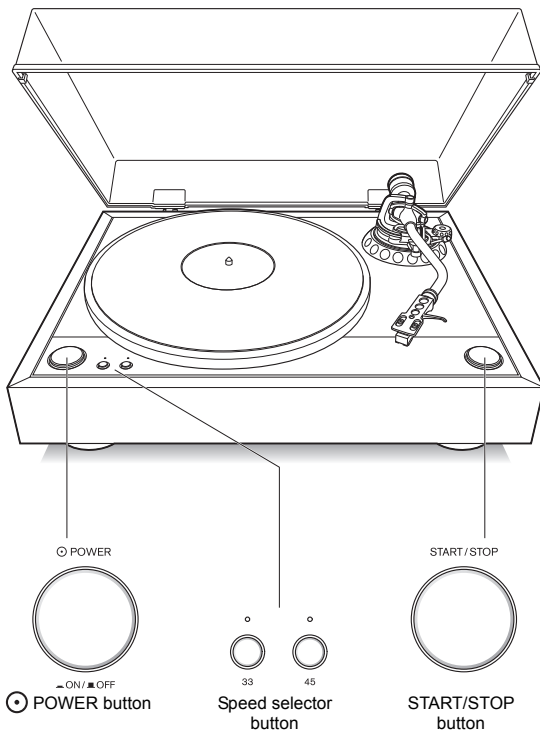

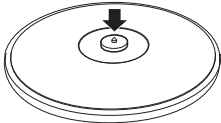
1. Press the **POWER** button to turn on the power supply.  
The indicator of the speed selector button lights up.
  2. Put a record on the rubber mat.
    - If it is a record with a large hole, fit the supplied adapter for 45 rpm records into the center spindle.
- 
3. Set the speed selector button according to the record's playing speed.
    - "33": 33 1/3 rpm record
    - "45": 45 rpm record
 The indicator of the selected speed selector button lights up.
  4. Press the **START/STOP** button.  
The turntable starts revolving.

5. Raise the lifter lever, hold the head shell's finger hook, and move the tone arm to the desired position over the record.

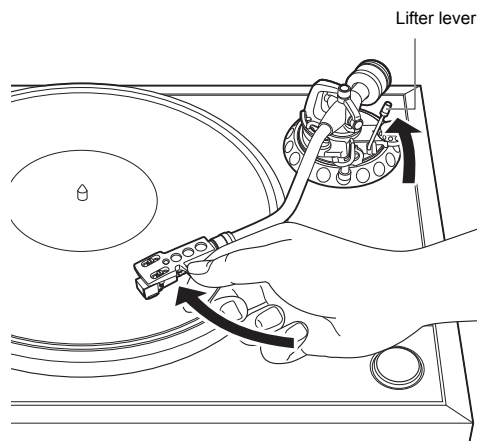

6. Lower the lifter lever.  
The tone arm will slowly descend until the stylus tip touches the record and start playing the music.
  - When lowering the stylus onto a record, keep the amplifier volume low so as not to create large noises and adjust the volume after the stylus tip touches the record.

## To stop playing the music

1. Lower the volume of the amplifier and then raise the lifter lever.
  - Lower the lifter lever to start playing the music again.
2. Hold the finger hook of the head shell and lower the lifter lever after returning the tone arm to the arm rest.
3. Press the **START/STOP** button.  
The turntable stops revolving.
  - The player will not stop automatically even when the record has finished playing.
  - Wait until the turntable stops revolving before replacing records.
  - Secure the tone arm with the arm clamp if you are not going to start playing the next tune immediately.
4. Press the **POWER** button to turn off the power supply.
  - Put on the stylus cover to protect the stylus tip if you are not going to use it for a while.

### For European models



**Auto-standby function:** If the unit is not operated for about an hour with the turntable stopped, it will automatically go into the standby mode. (The indicator of the speed selector button will go off.) Power consumption is reduced in the standby mode. Press the **START/STOP** button or the speed selector button in the standby mode to return to the power on state.

# Troubleshooting

## Before starting the procedure

Problems may be solved by simply turning the power on/off or disconnecting/connecting the power cord, which is easier than working on the connection, setting and operating procedure. Try the simple measures on both the unit and the connected device.

## The unit does not turn on.

- Confirm that the power plug is securely plugged in to an outlet.
- Set the  POWER button to the  OFF state by pressing it once and then set it to the  ON state by pressing it again after waiting for 5 seconds or longer.

## Stylus does not lower onto record.

- Lower the lifter lever.
- Check whether the stylus pressure has been adjusted correctly.
- Check whether the tone arm is balanced horizontally.

## No sound is produced.

### Sound is too weak.

- Check the input and volume of the amplifier.
- If a commercial phono-equalizer is connected, check whether its power supply is turned on.
- Make sure the pin cables with attached grounding are connected correctly.
- If connected to an amplifier with no PHONO input terminal, sufficient volume and the correct sound quality cannot be obtained. In this case, connect a commercial phono-equalizer between the unit and the amplifier before use.

## A low booming sound (hum or buzz) is heard when music is played.

- Check whether the pin cables with attached grounding are connected correctly (including the grounding line).
- Keep electrical appliances such as fluorescent lamps and power cords as far away as possible from the pin cables with attached grounding.
- Check whether the head shell is securely fastened by the locking nut.



## Stylus jumps.

- Check whether the unit is subject to any vibration.
- Check whether the stylus pressure and anti-skating are adjusted correctly.
- Check whether there are any scratches or warps on the record.
- Remove any dust attached to the stylus tip.

## No sound comes out after replacing the stylus with a special replacement stylus (DN-105ST).

- Fit the stylus properly until a clicking sound is heard.

## The indicator of the speed selector button blinks.

- Check whether the supplied turntable is properly plugged into the center spindle.
- Check whether the rotation of the turntable is blocked by anything.
- Press the  POWER button once to turn off the power supply and then press the  POWER button again to turn it back on.

# Handling

## Handling and maintenance of stylus

Take due care when handling the stylus as the stylus tip is extremely delicate.

Remove any dust attached to the stylus tip using a brush with a soft tip by brushing from the base of the stylus towards the end. You can also use a special cleaner available commercially for cleaning.

## Replacing the stylus

The life-span of the stylus is normally about 500 hours but varies greatly depending on the usage conditions. When the stylus tip is worn out, high frequencies may go out of pitch or the record may be damaged. Promptly replace the stylus in this case. Use a special replacement stylus (DN-105ST) to replace the stylus for the CP-1050. See the manual supplied with the replacement stylus for the replacement method.

## Maintenance of records

Use a commercial record cleaner to wipe the records thoroughly. If the record is dirty, the stylus may be damaged, resulting in noise and jumping sounds.

## When relocating the unit

Repackage the unit in the packaging it came in. If you no longer have the packaging, do the following:

- Take off the turntable and rubber mat and carefully wrap them.
- Remove the counterweight and head shell from the tone arm and carefully wrap them.
- Secure the tone arm with the arm clamp and then tie it with a string so that it does not move.
- Carefully wrap the unit in a blanket or soft paper.

# Specifications

## ■ Turntable section

Drive method:	Direct drive
Turning speed:	33 1/3 rpm, 45 rpm
Wow and flutter:	0.15 % or less
Signal to noise ratio:	60 dB or above
Turntable:	Aluminum die-cast Diameter 305 mm
Motor:	Brushless DC motor
Starting torque:	1.0 kgf-cm or above

## ■ Tone arm section

Type:	Static balance, S-shaped tone arm
Effective length:	230 mm
Overhang:	15 mm
Tracking error angle:	Within 3°
Stylus pressure adjustment range:	0 g to 4 g
Applicable cartridge weight range (including a head shell):	15 g to 20 g

## ■ Cartridge section (OC-105)

Type:	MM
Load resistance:	47 kΩ
Output voltage:	2.5 mV ± 3 dB
Stylus pressure:	3.5 g ± 0.5 g
Replacement stylus:	DN-105ST
Cartridge weight:	5 g
Head shell weight:	10 g

## ■ General

Power supply:	(North American) AC 120 V, 60 Hz (European) AC 220 - 240 V, 50/60 Hz
Power consumption:	(North American) 4 W (European) 6 W
Standby power consumption:	(European) 0.4 W
Dimensions (W × H × D):	450 mm × 158 mm × 367.5 mm (17-11/16" × 6-1/4" × 14-7/16")
Weight:	8.6 kg (19.0 lbs.)

Specifications and features are subject to change without notice.



# ONKYO

## Onkyo Corporation

Kitahama Chuo Bldg, 2-2-22 Kitahama, Chuo-ku, OSAKA 541-0041, JAPAN  
<http://www.onkyo.com/>

## The Americas

### Onkyo U.S.A. Corporation

18 Park Way, Upper Saddle River, N.J. 07458, U.S.A.  
For Dealer, Service, Order and all other Business Inquiries:  
Tel: 201-785-2600 Fax: 201-785-2650  
<http://www.us.onkyo.com/>

For Product Support Team Only:  
1-800-229-1687  
<http://www.us.onkyo.com/>

## Europe

### Onkyo Europe Electronics GmbH

Liegnitzerstrasse 6, 82194 Groebenzell, GERMANY  
Tel: +49-8142-4401-0 Fax: +49-8142-4208-213  
<http://www.eu.onkyo.com/>

### Onkyo Europe Electronics GmbH (UK Branch)

Meridien House, Ground floor, 69 - 71 Clarendon Road, Watford, Hertfordshire, WD17 1DS, United Kingdom  
Tel: +44 (0)8712-00-19-96 Fax: +44 (0)8712-00-19-95

## China

### Onkyo China Limited (Hong Kong)

Unit 1033, 10/F, Star House, No 3, Salisbury Road, Tsim Sha Tsui Kowloon, Hong Kong.  
Tel: 852-2429-3118 Fax: 852-2428-9039  
<http://www.hk.onkyo.com/>

### Onkyo China PRC (Mainland)

1301, 555 Tower, No.555 West NanJing Road, Jing'an District, Shanghai, China 200041,  
Tel: 86-21-52131366 Fax: 86-21-52130396  
<http://www.cn.onkyo.com/>

## Asia, Oceania, Middle East, Africa

Please contact an Onkyo distributor referring to Onkyo SUPPORT site.  
<http://www.intl.onkyo.com/support/>

The above-mentioned information is subject to change without prior notice.  
Visit the Onkyo web site for the latest update.

SN 29401915

(C) Copyright 2014 Onkyo Corporation Japan. All rights reserved.

F1410-0



\* 2 9 4 0 1 9 1 5 \*